



**Internship report on**

## **IP Telephony System**

**Company: KrisEnergy Bangladesh Ltd.**

**Department: IT**

**Submitted To:**

**M. Ruhul Amin**

**Professor**

**Department of ECE**

**East West University**

**Submitted by:**

**Ishrat Nowrin Shoma**

**ID: 2010-1-55-004**

**Department of ETE**

**East West University**

**Date of submission: 7<sup>th</sup> September, 2014**

# Declaration

I am gratified to announce that this internship (ETE 498) report on —IP Telephony System under Technical Division of KrisEnergy Bangladesh Ltd. has been prepared by me under the guidance of Professor M. Ruhul Amin for the partial fulfillment of B.Sc in ECE program from the Department of Electronics & Communication Engineering (ECE), East West University. I also affirm that this report is original in nature and has not been submitted elsewhere for any other purpose.

## Signature

 07.08.2014

**Ishrat Nowrin Shoma**

ID: 2010-1-55-004

Department of ECE

Date: 24<sup>th</sup> August, 2014

# Acknowledgement

First and foremost with all my heartiest devotion I am grateful to almighty Allah for blessing me with such opportunity of learning and ability to successfully complete the report in due time.

My sincere and deep sense of appreciation goes to all those people who have helped me to prepare this report on IP Telephony System under technical division at KrisEnergy Bangladesh Ltd.

My heartfelt gratitude goes to Syed Sabbir Ahmed, head of IT department in KrisEnergy Bangladesh Limited, for his kind consultation and support. His hearty cooperation created the inspiration that made me enthusiastic in accomplished my internship.

Lastly and most importantly, I would like to express my gratitude to all my colleagues especially the Technology terms of KrisEnergy Bangladesh Limited for helping me throughout the internship period.

I want to thank my supervisor, Professor M. Ruhul Amin, faculty of Electronics and Communication Engineering department, East West University, for keeping track of my internship progress and giving me valuable advice and suggestions to complete the report in an appropriate manner.

# Abstract

This report describes about my experiences during my internship period in KrisEnergy Bangladesh Ltd. In this report I have tried to brief about the corporate life for the beginners as well as my work experience on IP telephony system. I tried to give a detail on what I have done and how I have learned about the practical application of IP phone from my colleagues.

There is information of some related equipments with IP Phone such as switch, router etc.

As my main work responsibility was to configure those devices I tried to give in details that how I configure those devices. I have also included the ideas about IP Phone System and its related problems and maintenance.

This report will help to understand about the corporate life and brief about the devices based on my knowledge that I gathered during the last three months of my internship period. Here I also shared my personal experience on the organization. The report is ended with concluding part with the references.

# Table of Contents

<b>Contents</b>	<b>Page No</b>
<b>Chapter 1</b>	
Introduction	6
Objectives of the report	7
Company profile	8
<b>Chapter 2</b>	
Main task performed	10
IP Telephony	10
IP Telephony architecture	10
<b>Chapter 3</b>	
Technologies Used in the Office	13
VoIP Technology for IP Phone	13
Equipment Used	14
PoE	14
Connectivity	15
Soft Keys	16
Common Phone Task	17
Phone Screen Icons	18
Buttons	19
Snapshots	20
Sip	23
SCCP	24
Working Procedure of IP –Phone System	25
IP Vs VoIP	25
VoIP Overview	29
VoIP Switching Types	29
Bandwidth for VoIP	37
Call Recording Tools	38
Voice Quality	39
Converting Voice into Data Packets	40
Buffering and Error Checking	41
IP Telephone/VoIP Audit	
QoS	43
<b>Chapter: 4</b>	
Conclusion	46
References	47

# Chapter: 1

## Introduction

As an Engineering student field experience is must to judge the knowledge that one has acquired in their university education life. As I have gathered knowledge from my university education, I wanted to experience and learn the procedure of using this knowledge in their field sector. Thus I have chosen this internship program in KrisEnergy Bangladesh Ltd. It is my first time to meet the corporate life.

# Objectives of the Report

## Primary Objectives

- a) The primary objective of this report is to study on IP phone and introducing problems on this.
- b) Also introduced with new equipment and configure those items.
- c) The communication procedure in the office with Cisco IP phone.

## Secondary Objectives

- a) To find about the organization in brief.
- b) Elaborate the project I was involved in throughout my internship period.
- c) To explain my job responsibility as an intern.
- d) To explain how the project was being undertaken.
- e) To identify the advantages while implementing the project.
- f) To identify the problems associated during implementation of the project.
- g) To identify the problems that may arise in future after the implementation of the project.
- h) To recommend some guidelines to overcome the problems and provide some suggestions how, in a better way, the system can be developed in future.

# Company Profile

KrisEnergy Bangladesh Ltd is a multinational Oil and Gas Company. The oil and gas industry is typically divided into three major sectors: upstream, midstream and downstream. The upstream sector, in which KrisEnergy operates, is also commonly known as the exploration and production (E&P) sector.

KrisEnergy holds interests in 19 licences in Bangladesh, Cambodia, Indonesia, Thailand and Vietnam covering a gross acreage of approximately 71,625 sq km. Bangladesh operates 11 of the contract areas among the total 19 licenses.

KrisEnergy is a highly motivated team of geoscientists, engineers, operations specialists and business development executives focused on building the premier independent oil and gas company in Southeast Asia.

## Corporate Information

**Company name:** KrisEnergy Bangladesh Ltd.

**Singapore head office:** 83 Clemenceau Avenue, #10-05 UE . Square, Singapore, 239920.  
Phone: +65 6838 5430, Fax: +65 6538 3622. Website: [www.krisenergy.com](http://www.krisenergy.com)

**Bangladesh Branch Office:** NB Tower, Level 10, 11, 12. 40/7, North Avenue, Gulshan 2, Dhaka – 1212. Phone: +88 96664 11101, Fax: +88 2988 7257

**Details of Ownership:** Singaporean Private Limited Company

**Capital:** USD 20 Million

### Management Team:

**Chief Executive Officer:** Keith Cameron

**Director Exploration & Production:** Chris Gibson Robinson

**CFO and VP Finance:** Kiran Raj

**Head of Investor Relations:** Tania Pang

**General Manager:** Edwin Bowles



**Shareholders:**

**First Reserve** has offices in Greenwich, CT; Houston; London and Hong Kong.

**The Keppel Group of Companies** includes Keppel Offshore & Marine, Keppel Energy, Keppel Integrated Engineering, Keppel Telecommunications & Transportation (Keppel T&T) and Keppel Land, among others.

# Chapter: 2

## Main task performed

In my internship period at KrisEnergy first I gathered some knowledge about IP Telephony System. In today's networking and cabling industry, the buzzword is IP telephony. Many see it as a major evolutionary step in telecommunications. This technology uses the Internet Protocol (IP) to transport voice signals over a data network. Instead of using the conventional analog voice signal (sine wave signal), human speech is converted into a digital signal (1s and 0s) just like the data packets that travel through the data network. IP telephony is more revolutionary than evolutionary because it merges two very different yet critical worlds:

- a) Voice telephony (highly cost sensitive; needs rock-solid reliability); and
- b) Data networks (accept occasional failures; subject to rapid change; need a lot of bandwidth).

A solution that merges these two worlds must simultaneously offer reliability, cost effectiveness, a high data rate and the ability to evolve — quickly. That's quite a challenge for IP telephony solution providers. They must develop and market a solution that takes into account these seemingly incompatible needs. The pros and cons of IP telephony versus "classic" telephony have been debated in many papers and will not be rehashed here. We want to focus on the impact IP telephony will have on the design and deployment of LAN structured cabling.

## IP Telephony

IP-Telephony is the method of routing voice through the internet or any other IP-based network by turning analog audio signals into transmissible digital data. The data is transmitted through a packet-switched network instead of the traditional circuit-switched used in common telephone land lines.

## IP Telephony Architecture

### IP telephony devices

Once the choice to use IP telephony is made, one must choose the interface between the voice packet and the user. Two options are available for the job:

- a) An IP phone, which looks like a phone, but is more like a PC; or a "hard phone"

b) A PC with IP telephony software and microphone/speaker or USB handset, or a “soft phone.”

All the major IP telephony companies market IP phones. With list prices ranging from US\$300 to more than US\$1000 they are substantially more expensive than regular phone sets. However, the advanced models allow access to more advanced services, including Web surfing and Internet banking. They can also be used as “port extensions” to connect a computer directly to the phone. If IP phones make the data world look like a voice world, the “soft phone” (a PC with IP telephony software) plunges the user into the data world, with voice communication done directly through the computer. Since most of today’s computers have integrated speakers and microphones, the only significant incremental cost is the license for the IP telephony software. It is also possible to purchase an IP telephone set that looks like a standard phone set, but links directly to the computer’s USB port.

## IP telephony architecture

**Single-Site IP Telephony Architecture:** A single-site design has all the IP telephony components at one site, as illustrated in the following Figure

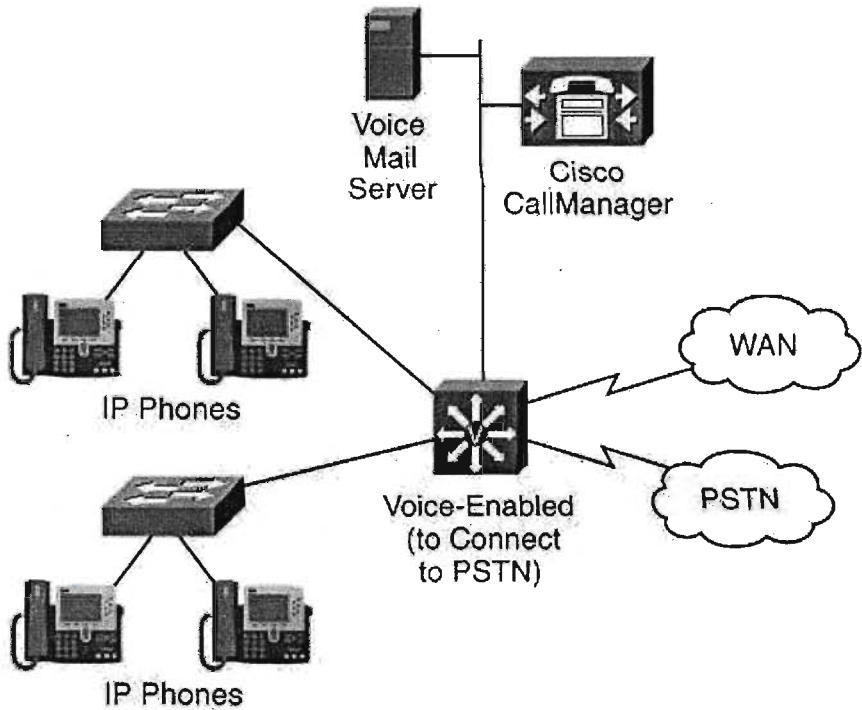
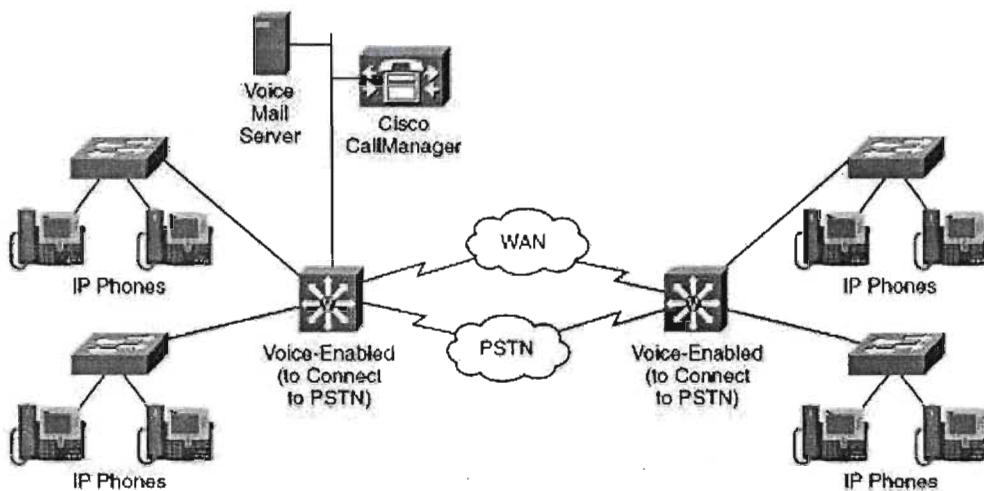

**Figure: IP Telephony Single-Site Architecture**

In this scenario, the IP phones (connected to switches that can provide them in-line power), a call-processing engine (CCM), application servers, and optionally a voice gateway to the PSTN are at the

same physical location. Each site is self-contained, and all calls between sites are through the PSTN. This means that the IP WAN is not involved in voice calls and is therefore not a voice bottleneck.

**Multisite Centralized IP Telephony Architecture:** A multisite design has many sites, interconnected through a WAN. As illustrated in the following Figure.



**Figure: IP Telephony Multisite Centralized Architecture**

A centralized design means that the call-processing engine and application servers are at one of the sites, and the other sites connect to those devices for all call-processing and application requirements. Because the remote sites must send call-processing information to the main site, they must have IP connectivity with the main site. Therefore, if the WAN is down, calls cannot be processed. To prevent a total breakdown of the IP telephony system, the Survivable Remote Site Telephony (SRST) feature on remote routers can be used to provide basic call processing to the remote sites if the WAN fails.

If PSTN access is not required, a voice-enabled router is not necessary in this scenario, because only IP packets are sent across the WAN. However, if PSTN access is required (which is the usual case), a voice gateway is required.

# Chapter: 3

## Technologies used in the office

For voice Telecommunications purpose bellow technologies are being used at the moment.

- a) Public Switched Telephone Network (PSTN).
- b) Voice over Internet Protocol (VOIP) between Dhaka and Comilla gas field.
- c) Session Initiation Protocol (SIP) from VOIP service providers.

### PSTN

The **public switched telephone network (PSTN)** is the aggregate of the world's circuit-switched telephone networks that are operated by national, regional, or local telephony operators, providing infrastructure and services for public telecommunication. The PSTN consists of telephone lines, fiber optic cables, microwave transmission links, cellular networks, communications satellites, and undersea telephone cables, all interconnected by switching centers, thus allowing any telephone in the world to communicate with any other. Originally a network of fixed-line analog telephone systems, the PSTN is now almost entirely digital in its core network and includes mobile and other networks, as well as fixed telephones.

The PSTN relies on **circuit switching**. To connect one phone to another, the phone call is routed through numerous switches operating on a local, regional, national or international level. The connection established between the two phones is called a **circuit**.

### VoIP technology for IP phone

An IP Phone uses Voice over IP (Voice over Internet Protocol - VoIP) technologies for placing and transmitting telephone calls over an IP network, such as the Internet, instead of the traditional public switched telephone network (PSTN).

Digital IP-based telephone service uses control protocols such as the Session Initiation Protocol (SIP), Skinny Client Control Protocol (SCCP) or various other proprietary protocols.

## VOIP:

There is a VPN (Virtual Private Network) tunnel established between Dhaka office and Bangora.

### Equipment Used:

For handling all sorts of incoming and outgoing call, the world renowned CISCO Call Manager Express running on a CISCO C2921-CME-SRST/K9 router is being used.

At the user end CISCO IP Telephone sets are being used. IP phone models include 7965, 7940.

CISCO LAN switches (model) with PoE ports are used to provide power to all the IP phone sets.

## PoE

**Power over Ethernet** or **PoE** describes any of several standardized or ad-hoc systems which pass electrical power along with data on Ethernet cabling. This allows a single cable to provide both data connection and electrical power to devices such as wireless access points or IP cameras.



**Figure: Power over Ethernet**

Given a single Power over Ethernet connection (single gray cable looping below), a PoE splitter provides both data (gray cable looping above) and power (black cable also looping above) connections for a wireless access point. The splitter is the silver and black box in the middle, between the wiring box on the left and the access point (with its two antennas) on the right. The PoE connection eliminates the need for a nearby power outlet.

# Connectivity

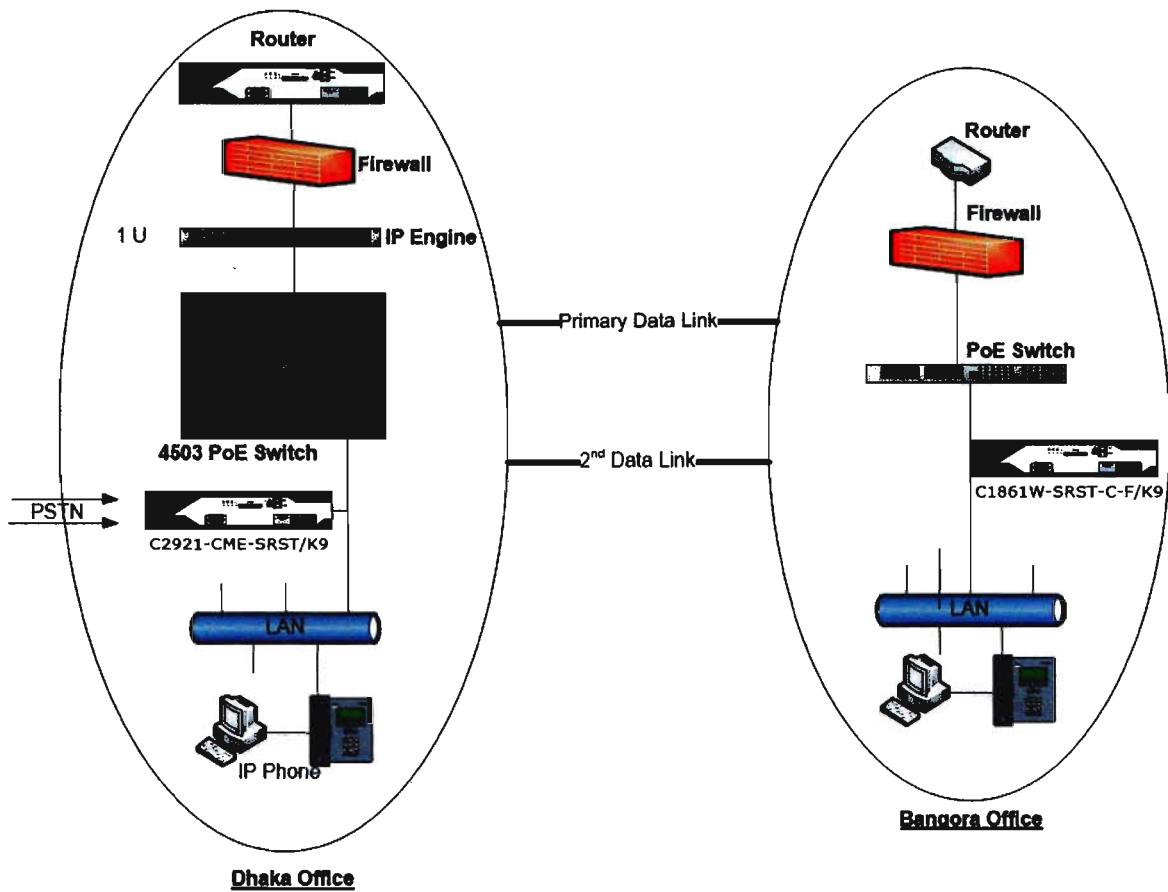

As can be seen in the diagram all sorts of connectivity like PSTN are terminated into the CISCO call manager router.

The IP phones communicate with the call manager over the LAN. CISCO switches with PoE (Power over Ethernet technology) enabled ports are being used in the LAN that gives power to the IP phones.

Extension for all desks IP phones, extensions for the different types of outgoing lines (PSTN, SIP) are all configured in the call manager software in the router.

## Cisco Unified IP Phone C2921-CME-SRST/K9 for Cisco Unified Communications Manager 8.5 (SCCP and SIP)







### Soft keys

All Calls	Lists all missed, placed, and received calls.
Answer	Answer a call.
Apply	Confirm a ringtone selection.
Call	Initiate a call.
Callback	Receive notification when a busy extension becomes available.
Cancel	Cancel an action or exit a screen without applying changes.
Clear	Clear all values.
Delete	Delete an entry from Call History.
Del Call	Delete a call from Call History.
Details	Opens the Details for a multiparty call in the Missed, Placed, and Received Call records.
Dial	Dial a selected number.
Divert	Send or redirect a call to voicemail or to a predetermined phone number.
Edit	Modify a name or email address.
Edit Dial	Modify a number.
Exit	Return to the previous screen.
Fwd All/Fwd OFF	Setup/cancel call forwarding.
G Pickup	Answer a call that is ringing in another group or on another line.
Log Out	Sign out of Personal Directory.
Meet Me	Host a Meet Me conference call.
Missed	Open the record of missed calls.
more	Display additional soft keys.
New Call	Make a new call.
OK	Confirm a selection.
O Pickup	Answer a call that is ringing in an associated group.
Park	Store a call.
Play	Play ringtone.
Pick Up	Answer a call that is ringing on another phone in your





















	group.
<b>Redial</b>	Redial the most recently dialed number.
<b>Remove</b>	Remove a conference participant or an entry.
<b>Resume</b>	Resume a call on hold.
<b>Save</b>	Save the chosen settings.
Search	Search for a directory listing.
Select	Select the highlighted option.
Set	Set a ringtone.
Submit	Enter user information.
Swap	Toggle between two existing calls.
Update	Update an entry in Personal Directory.
>>	Move through entered characters.
	











## Common Phone Tasks

Place a call	Go off-hook before or after dialing a number.
Redial a number	Press <b>Redial</b> .
Switch to handset during a call	Pick up the handset.
Switch to speaker or headset during a call	Press  or  , then hang up the handset.
Mute and un-mute a call	Press  .
View call history	Press  > <b>Call History</b> .
Hold and resume a call	Press  , to hold. Press <b>Resume</b> to resume the held call.
Transfer a call to new number	Press  , enter the number, then press it again.
Place an intercom call	Press the <b>Intercom</b> button, then enter a number if necessary. Speak after you hear the tone.
Start a standard conference call	Press  , dial the participant, then press it again.
Silence the ring for an incoming call	Press the <b>Volume</b> button down once.

## Phone Screen Icons

	Off-hook
	On-hook
	Connected call
	Incoming call
	Missed call
	Received call
	Placed call
	Call on hold
<b>Feature Icon (If available on your phone)</b>	
	Message waiting
	Shared line in use
	Speed dial line
	Line Status indicator-monitored line is in-use
	Line Status indicator-monitored line is idle
	Line Status indicator-monitored line is ringing
	Line Status indicator-monitored line is in do not disturb (DND)
	Idle intercom line
	One-way intercom call (whisper)
	Two-way intercom call (connected)

# Buttons

	Applications
	Contacts
	Messages
	Transfer
	Hold
	Conference
	Volume
	Speakerphone
	Mute
	Headset
	Navigation bar and Select button

## Here are some snapshots of the application

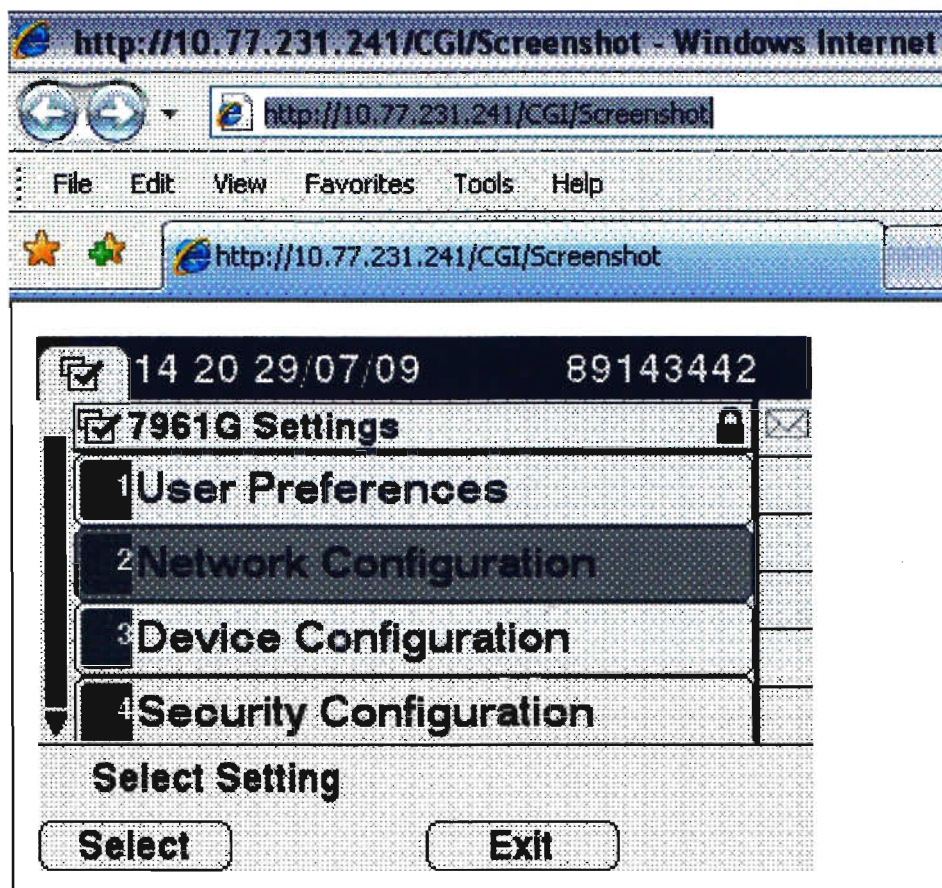

This document describes how to troubleshoot the Cisco IP Phone Error Number error message with Cisco Unified Communications Manager 7.x.

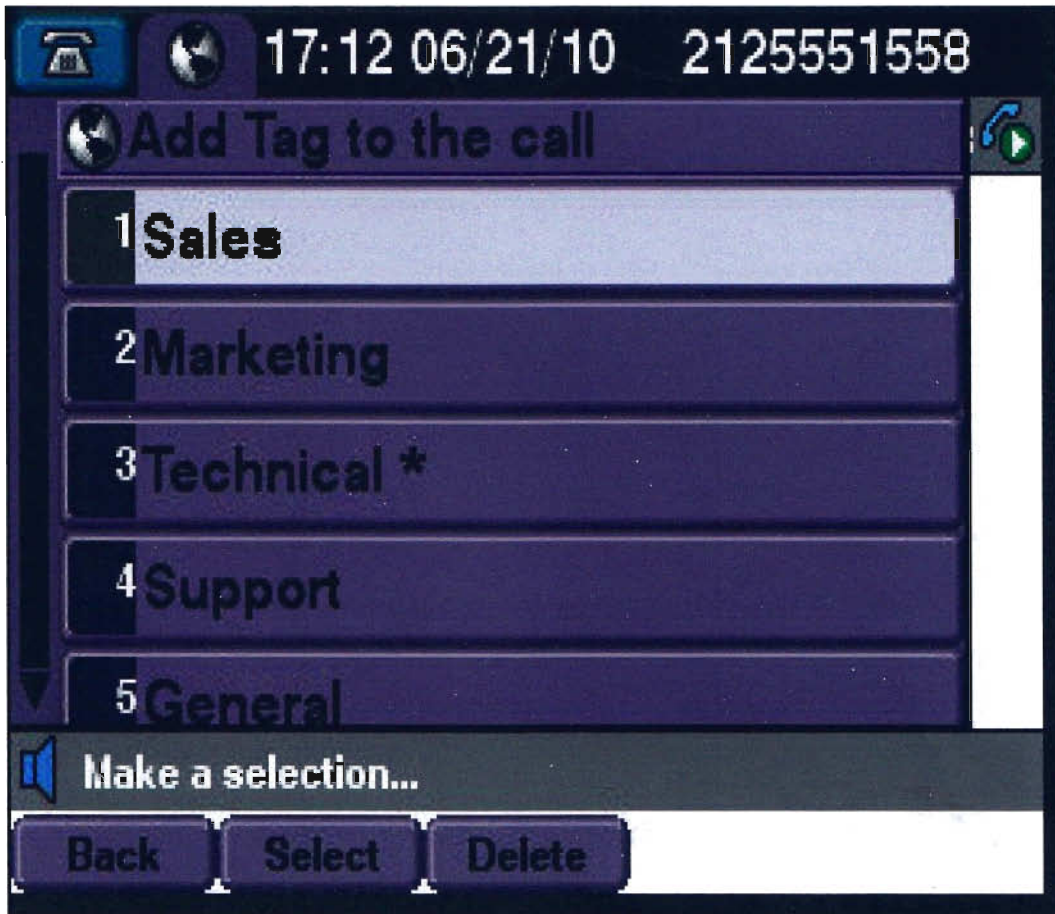

Screenshot of the Verba Recording System web based user interface showing the feature rich, built-in player application, which provides easy-to-use features like: play, stop, pause, forward, rewind, play selected, volume control, playback speed control, balance control, visual waveform, markers, etc.



Some functions may be disabled or fail to work when utilizing older phones with capabilities below that of a CP-7941. These applications are accessible from anywhere in the world, but focus on Australian Content.

# SIP

SIP, the session initiation protocol, is the IETF (Internet Engineering Task Force) protocol for VOIP and other text and multimedia sessions, like instant messaging, video, online games and other services.

SIP invitations used to create sessions carry session descriptions that allow participants to agree on a set of compatible media types. SIP makes use of elements called proxy servers to help route requests to the user's current location, authenticate and authorize users for services, implement provider call-routing policies, and provide features to users. SIP also provides a registration function that allows users to upload their current locations for use by proxy servers. SIP runs on top of several different transport protocols.

## SIP lines:

The provider terminated a fiber link to the Dhaka office server room from their premises. Inside the server room the fiber is converted to Cat6 UTP cable using a converter that is then connected directly to one RJ45 port of the call manager router. This way the call manager communicates with the provider's router to handle incoming and outgoing calls.

## SIP Operation

Sip works as follows:

Callers and callees are identified by SIP addresses. When making a SIP call, a caller first locates the appropriate server and then sends a SIP request. The most common SIP operation is the invitation. Instead of directly reaching the intended callee, a SIP request may be redirected or may trigger a chain of new SIP requests by proxies. Users can register their location(s) with SIP servers.

SIP messages can be transmitted either over TCP or UDP  
SIP messages are text based and use the ISO 10646 character set in UTF-8 encoding. Lines must be terminated with CRLF. Much of the message syntax and header field are similar to HTTP. Messages can be request messages or response messages.

# SCCP (Signaling Connection Control Part)

The **Signaling Connection Control Part (SCCP)** layer of the SS7 stack provides connectionless and connection-oriented network services and global title translation (GTT) capabilities above MTP Level 3. SCCP is used as the transport layer for TCAP-based services. It offers both Class 0 (Basic) and Class 1 (Sequenced) connectionless services. SCCP also provides Class 2 (connection oriented) services, which are typically used by Base Station System Application Part, Location Services Extension (BSSAP-LE). In addition, SCCP provides Global Title Translation (GTT) functionality.

The signaling connection control part (SCCP) provides two major functions that are lacking in the MTP. The first of these is the capability to address applications within a signaling point. The MTP can only receive and deliver messages from a node as a whole; it does not deal with software applications within a node.

VoIP, or Voice over Internet Protocol, is a method for taking analog audio signals, like the kind you hear when you talk on the phone, and turning them into digital data that can be transmitted over the Internet.

VoIP can turn a standard Internet connection into a way to place free phone calls. The practical upshot of this is that by using some of the free VoIP software that is available to make Internet phone calls, you're bypassing the phone company (and its charges) entirely.



# IP Telephony vs. VoIP

Let's define what IP telephony and VoIP mean in this document. IP telephony is the combination of voice, data, video, and wireless applications into an integrated enterprise infrastructure that offers the reliability, interoperability, and security of a voice network, the benefits of IP, and the efficiencies, mobility, and the manageability of a single network.

IP telephony is based on circuit-switched and TCP/IP technologies and protocols; it removes the limitations of proprietary systems and provides increased productivity, scalability, mobility, and adaptability.

Voice over IP (VoIP) is the technology that is used to transmit voice over an IP network, which can be either a corporate network or the Internet. VoIP is available on many smartphones, personal computers, and on Internet access devices. Calls and SMS text messages may be sent over 3G or Wi-Fi.

It allows to make voice calls using a broadband Internet connection instead of a regular (or analog) phone line. Some VoIP services may only allow to call other people using the same service, but others may allow to call anyone who has a telephone number - including local, long distance, mobile, and international numbers. Also, while some VoIP services only work over your computer or a special VoIP phone, other services allow you to use a traditional phone connected to a VoIP adapter.

## How IP phone system works

The "IP" in IP phone system refers to Voice over IP, or having your phone calls routed over the internet or your Local Area Network (LAN). This is great for many reasons. First of all, you don't have to use the telephone network of your telephony service provider for making calls, which will reduce your costs for phone calls. At the same time you are gaining many technical advantages by using IP technology for your telephony.

Users of VoIP phone system simply plug their IP phone into the nearest LAN port. Then, the IP phone registers automatically at the VoIP phone system. The IP phone always keeps its number, and behaves exactly the same way, no matter where you plug it in - on your desk, in the office next door or on a tropical island.

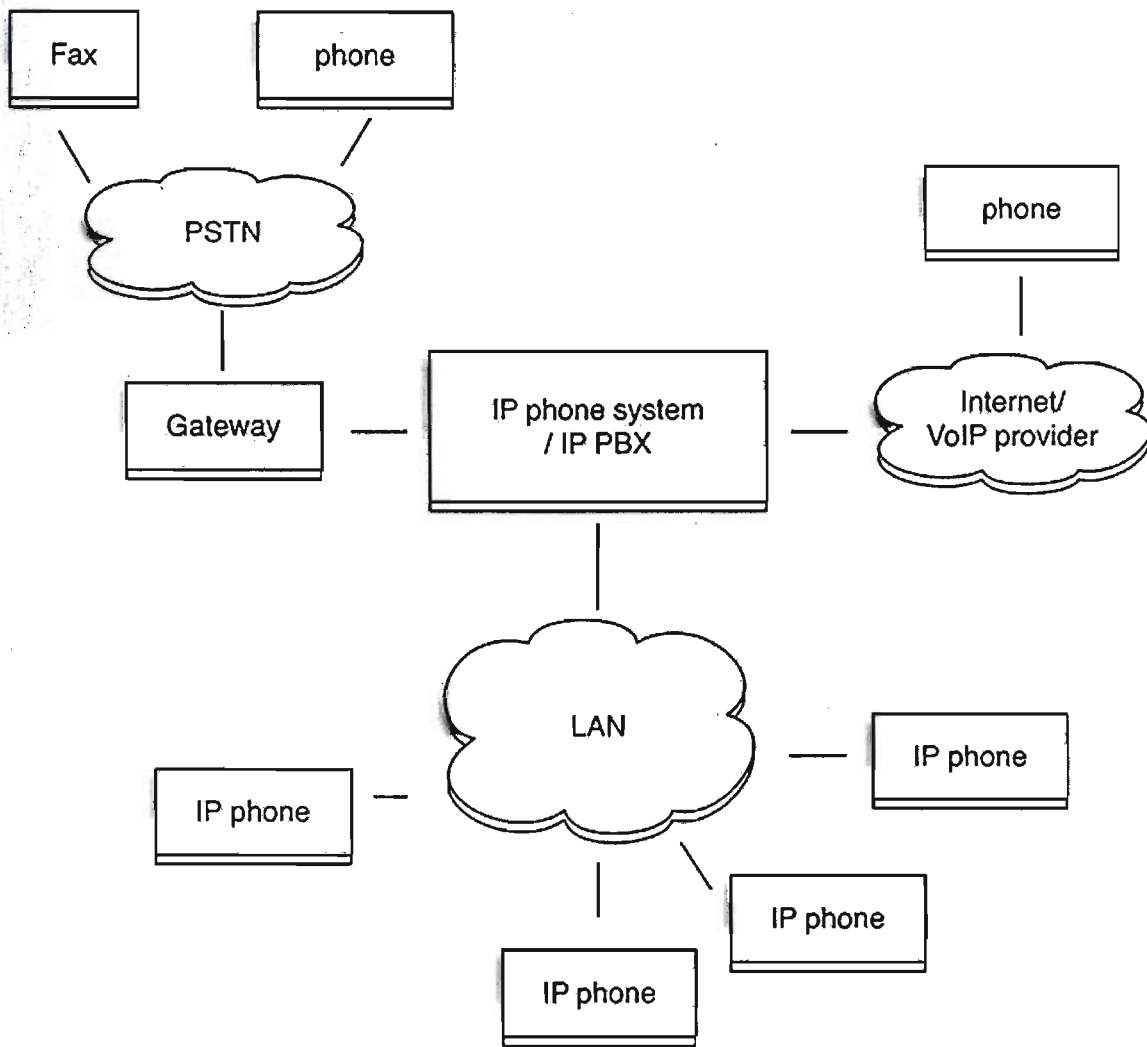

**Figure: Working procedure of IP phone systems**

All of this works because of the SIP protocol. It is a standard widely used by ISPs, VoIP phone systems and VoIP phones world-wide. It makes expensive proprietary phones obsolete, and helps that all devices can talk to each other.

IP phone systems are usually built on standard PC or embedded hardware which are more cost-effective and powerful than the hardware of the traditional phone manufacturers. At the same time, ip phone systems are scalable, as they are not limited to a certain number of physical phone ports. That means you don't need to replace your phone system when your company grows.

# How VoIP / Internet Voice Works

VoIP services convert your voice into a digital signal that travels over the Internet. If you are calling a regular phone number, the signal is converted to a regular telephone signal before it reaches the destination. VoIP can allow you to make a call directly from a computer, a special VoIP phone, or a traditional phone connected to a special adapter. In addition, wireless "hot spots" in locations such as airports, parks, and cafes allow you to connect to the Internet and may enable you to use VoIP service wirelessly.

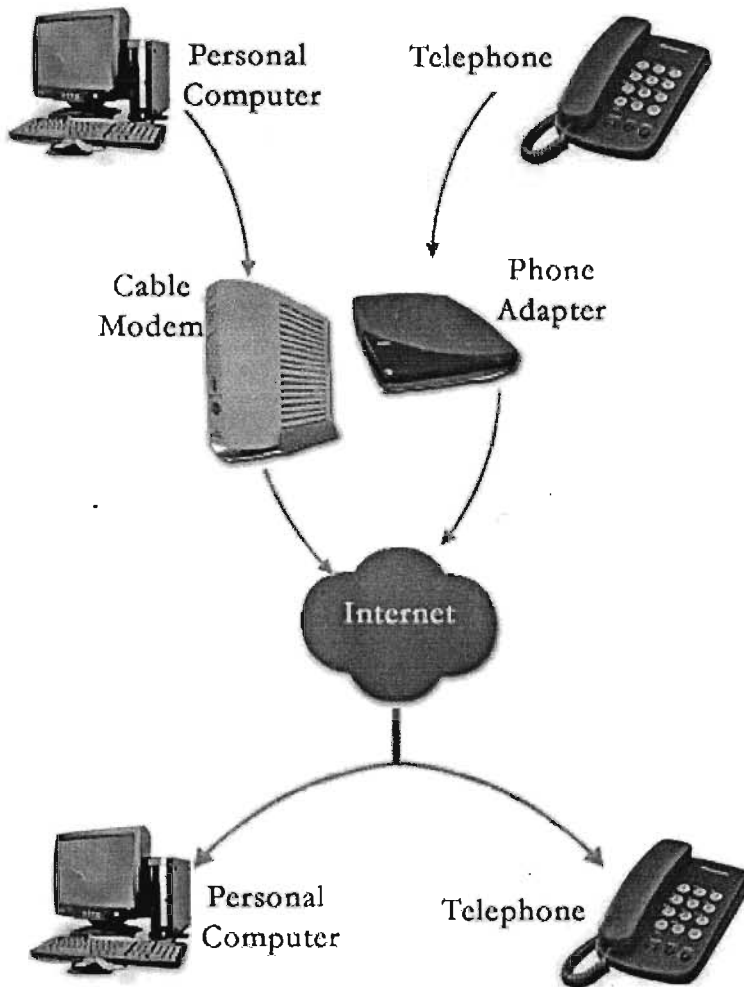

## What Kind of Equipment Do I Need?

**A broadband (high speed Internet) connection is required.** This can be through a cable modem, or high speed services such as DSL or a local area network. **A computer, adaptor, or specialized phone is required.** Some VoIP services only work over your computer or a special VoIP phone, while other services allow you to use a traditional phone connected to a VoIP adapter. If you use your computer, you will need some software and an inexpensive microphone. Special VoIP phones plug directly into your broadband connection and operate largely like a traditional telephone. If you use a telephone with a VoIP adapter, you'll be able to dial just as you always have, and the service provider may also provide a dial tone.

# VoIP Overview

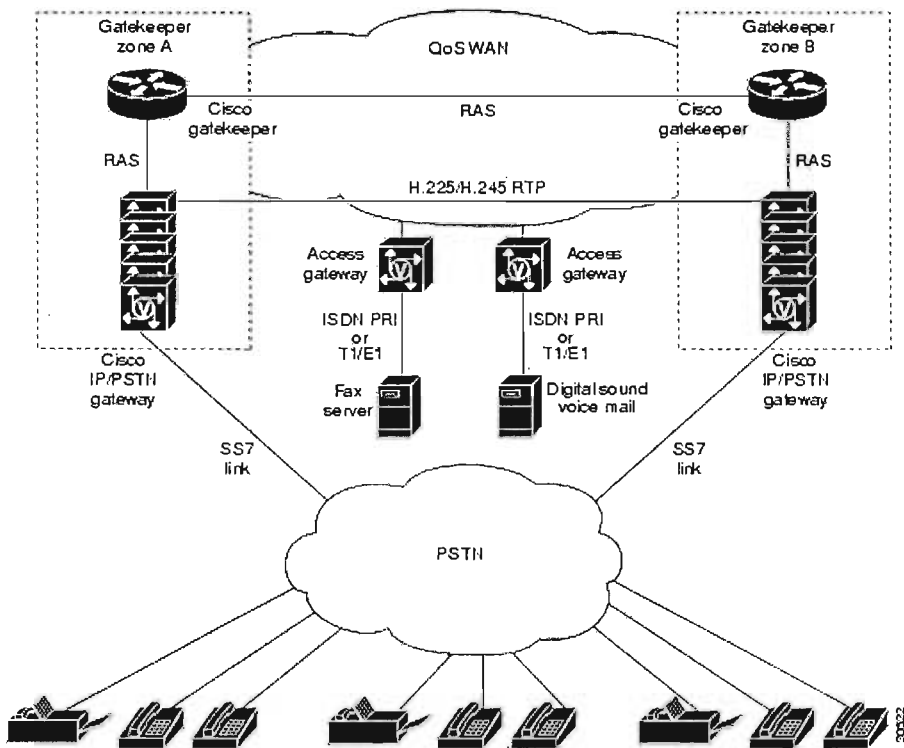

Figure: VoIP Overview

## Switching and Routing for VoIP

Switching and routing are technically two different things, but for the sake of simplicity, let us take switches and routers (which are devices that make switching and routing respectively) as devices doing one job: make a link in the connection and forward data from the source to the destination.

## VoIP Switching Types

The important thing to look for in transmitting information over such a complex network is the **path** or circuit. The devices making up the path are called nodes. For instance, switches, routers and some other network devices are nodes.

One decides on which route to follow, based on a resource-optimizing algorithm, and transmission goes according to the path. For the whole length of the communication session between the two communicating bodies, the route is dedicated and exclusive, and released only when the session terminates. The Internet Protocol (IP), just like many other protocols, breaks data into chunks and wraps the chunks into structures called packets. Each packet contains, along with the data load, information about the IP address of the source and the destination nodes, sequence numbers and some other control information. A packet can also be called a segment or datagram.

## Packet Switching

### A scenario Illustrating Packet Switching

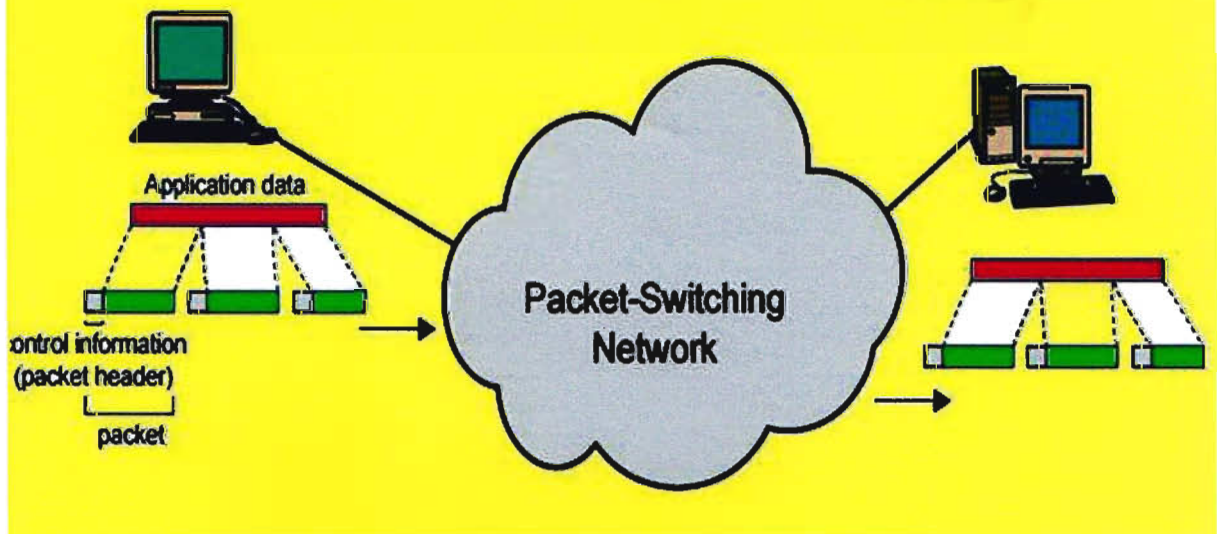

In **packet-switching**, the packets are sent towards the destination irrespective of each other. Each packet has to find its own route to the destination. There is no predetermined path; the decision as to which node to hop to in the next step is taken only when a node is reached. Each packet finds its way using the information it carries, such as the source and destination IP addresses.

As you must have figured it out already, traditional PSTN phone system uses circuit switching while VoIP uses packet switching.

## **IPv6 (IP version 6) OSPFv3 (Open Shortest Path First Version 3) ESP (Encapsulating Security Payload) Packets**

I am working on IPv6. While doing OSPFv3, I get to the encryption option, covered in a relative easy to read and informative RFC 4552. So now it is configured and I think to myself, this is great – now my routing protocol is secure on the wire. But hey, what if I need to see what is going on my network? What do I get to see now that it is encrypted?

# Doing a capture, this is what I got to see:

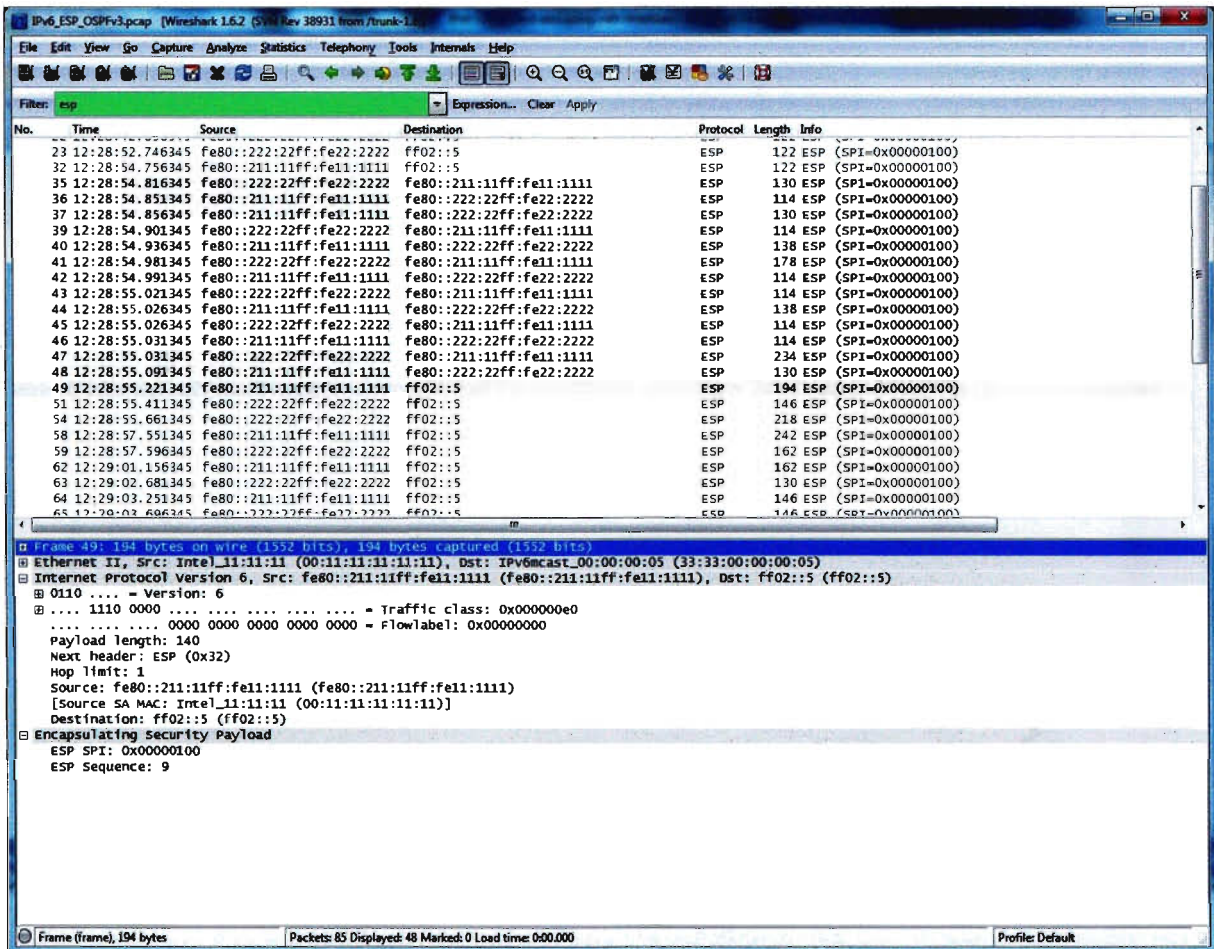

I have ESP packets in this capture. I see some are destined to FF02::5 (All SPF Routers), and the others are between my R1 and R2 link-local addresses.

Let's walk through a few steps to decode the ESP packets.

First, go to Edit > Preferences



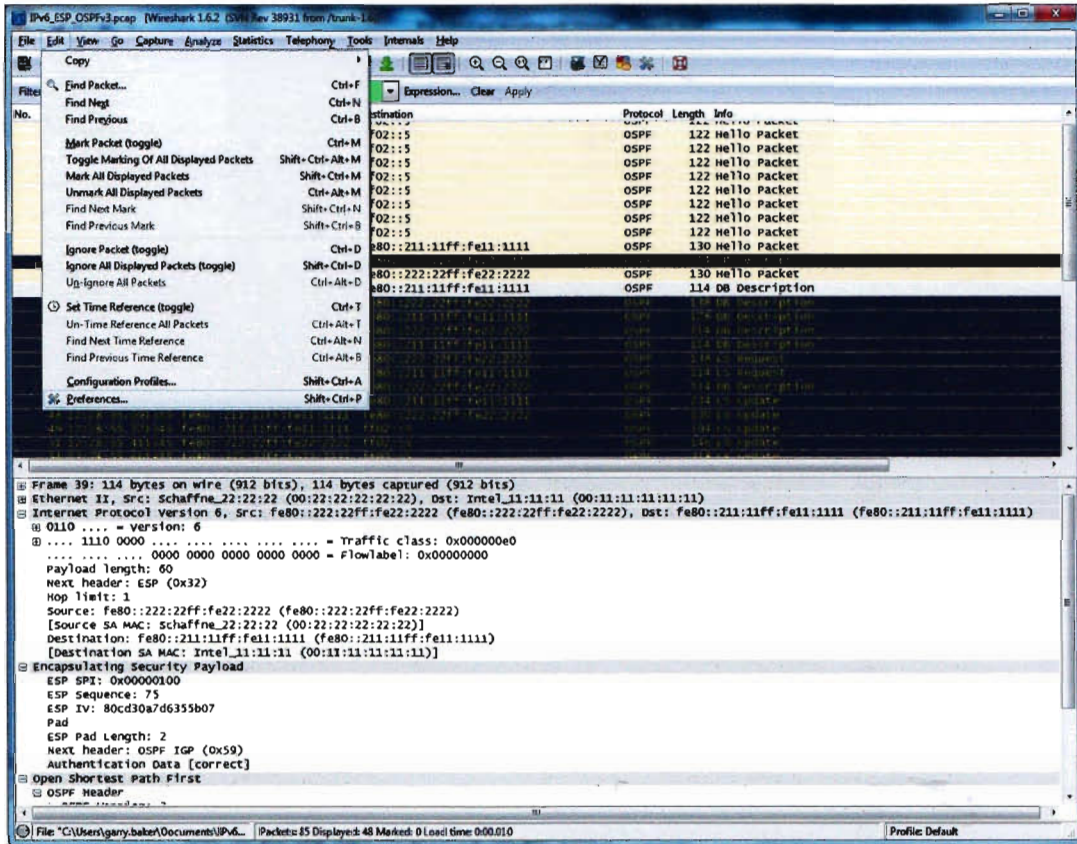

Second, find ESP under +Protocols to add the SA information - IPv6|source|destination|SPI, Encryption and Authentication Algorithm keys from R1 and R2

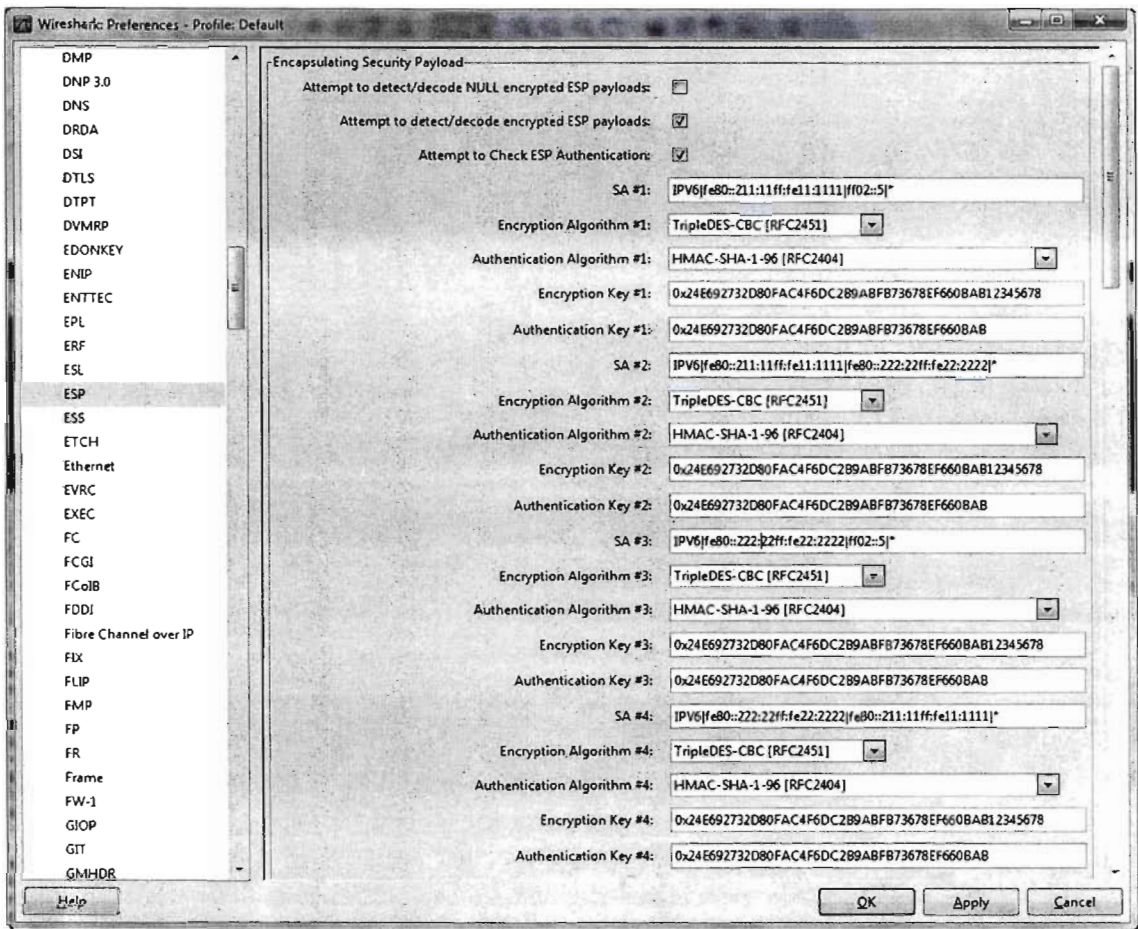

And finally, the result is decoded OSPFv3 packets to look at.

# Circuit Switching

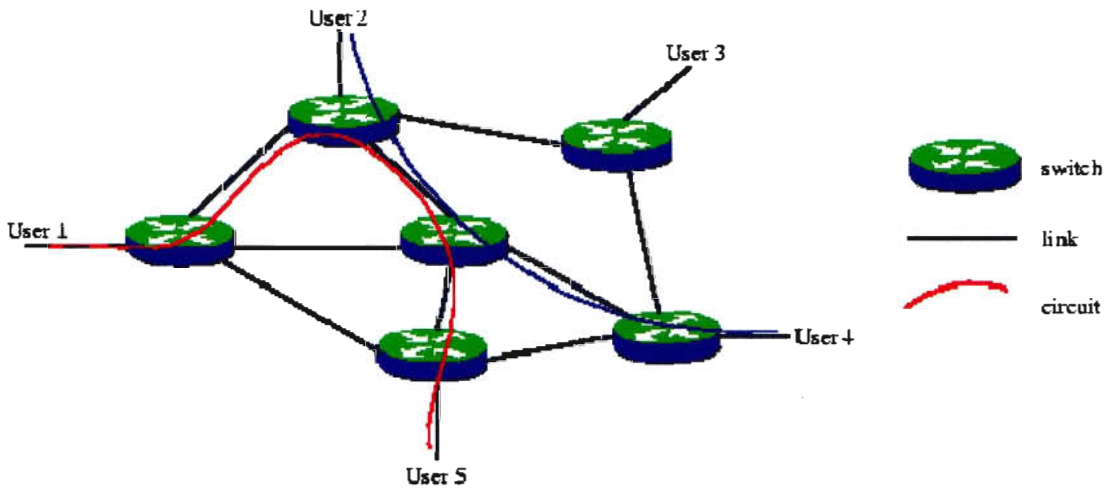

In **circuit-switching**, this path is decided upon before the data transmission starts. The system VoIP is a Layer 3 network protocol that uses various Layer 2 point-to-point or link-layer protocols such as PPP, Frame Relay, or ATM for its transport.

**Circuit switching** is the transmission technology that has been used since the first communication networks in the nineteenth century. In circuit switching, a caller must first establish a connection to a callee before any communication is possible. During the connection establishment, resources are allocated between the caller and the callee. Generally, resources are frequency intervals in a Frequency Division Multiplexing (FDM) scheme or more recently time slots in a Time Division Multiplexing (TDM) scheme. The set of resources allocated for a connection is called a circuit, as depicted in the figure. A path is a sequence of links located between nodes called *switches*. The path taken by data between its source and destination is determined by the circuit on which it is flowing, and does not change during the lifetime of the connection. The circuit is **terminated** when the connection is closed.

In circuit switching, resources remain allocated during the full length of a communication, after a circuit is established and until the circuit is terminated and the allocated resources are freed. Resources remain allocated even if no data is flowing on a circuit, hereby wasting link capacity when a circuit does not carry as much traffic as the allocation permits. This is a major issue since frequencies (in FDM) or time slots (in TDM) are available in finite quantity on each link, and establishing a circuit consumes one of these frequencies or slots on each link of the circuit. As a result, establishing circuits for communications that carry less traffic than allocation permits can lead to resource exhaustion and network saturation, preventing further connections from being established. If no circuit can be established between a sender and a receiver because of a lack of resources, the connection is **blocked**.

# R/C Timer Switch

20 ... 80 sec, adjustable

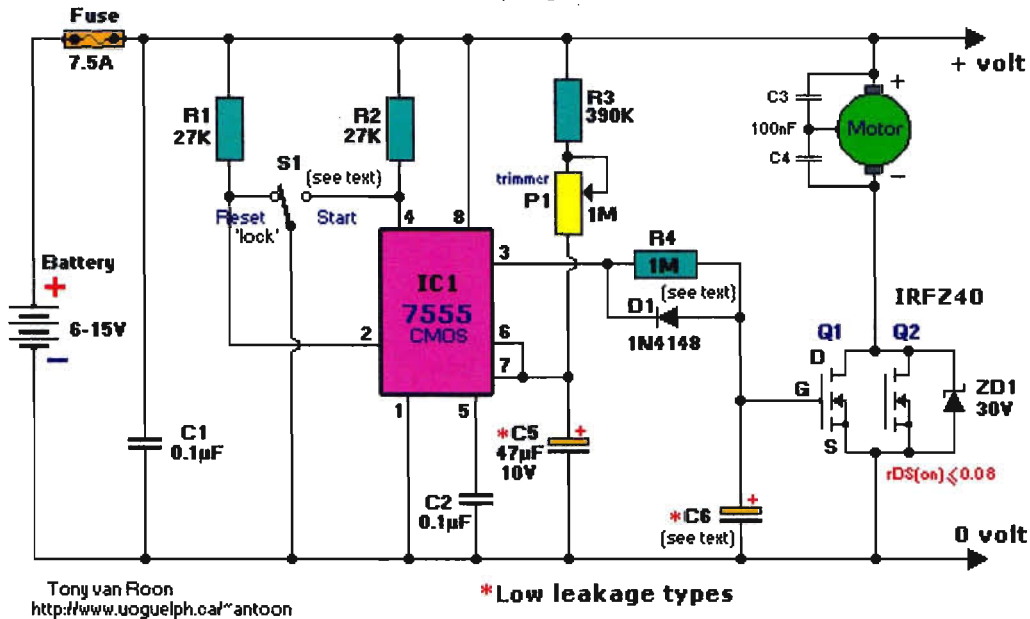

Figure: Circuit Switching

A second characteristic of circuit switching is the time cost involved when establishing a connection. In a communication network, circuit-switched or not, nodes need to look up in a **forwarding table** to determine on which link to send incoming data, and to actually send data from the input link to the output link. Performing a lookup in a forwarding table and sending the data on an incoming link is called **forwarding**. Building the forwarding tables is called **routing**. In circuit switching, routing must be performed for each communication, at circuit establishment time. During circuit establishment, the set of switches and links on the path between the sender and the receiver is determined and messages are exchanged on all the links between the two end hosts of the communication in order to make the resource allocation and build the routing tables. In circuit switching, forwarding tables are hardwired or implemented using fast hardware, making data forwarding at each switch almost instantaneous. Therefore, circuit switching is well suited for long-lasting connections where the initial circuit establishment time cost is balanced by the low forwarding time cost.

On the other hand, circuit switching networks are not reactive when a network topology change occurs. For instance, on a link failure, all circuits on a failed link are cut and communication is interrupted. Special mechanisms that handle such topological changes have been devised. Traffic engineering can alleviate the consequences of a link failure by pre-planning failure recovery. A backup circuit can be established at the same time or after the primary circuit used for a communication is set up, and traffic can be rerouted from the failed circuit to the backup circuit if a link of the primary circuit fails. Circuit switching networks are intrinsically sensitive to link failures and rerouting must be performed by additional traffic engineering mechanisms.

# Measuring Bandwidth for VoIP

Bandwidth is measured in Hertz (Hz), or Mega Hertz (MHz) because Hertz are counted in millions. One MHz is one million Hz. Connection speed (technically called the bit rate) is measured in Kilo bits per second (kbps). It is simply a measure of how many bits are transmitted in one second. I am going to use kbps or mbps to refer to transmission speed from now on, because that's what every service provider talks about when referring to the speed they offer. One mbps is one thousand kbps.

Let's have a look at some typical bandwidth associated with popular communication devices and technologies.

Technology	Speed	Use in VoIP
<u>Dial-Up</u> (modem)	Up to 56 kbps	Not suitable
<u>ISDN</u>	Up to 128 kbps	Suitable, for fixed and dedicated service
<u>ADSL</u>	Up to several Mbps	One of the best <u>WAN</u> technologies, but provides no mobility
<u>Wireless technologies</u> (e.g. WiFi, WiMax, GPRS, CDMA)	Up to several Mbps	Some technologies are suitable, while some are limited by distance and signal quality. They are the mobile alternatives to ADSL.
<u>LAN Ethernet</u>	(e.g. Up to thousands of Mbps (Gbps))	The best, but limited to the length of wires which can be short in most cases.
<u>Cable</u>	1 to 6 Mbps	High speed but limits mobility. Is suitable is you don't have to move.

# Voice Bandwidth Requirements

In the traditional voice world a single T1 leased line is used to carry 24, toll quality telephone calls from the public switched telephone network (PSTN). Those with a private point-to-point T1 connection can compress the voice to less than 8 Kbps for more efficiency, but the quality may be sacrificed. The three most common modulation schemes for encoding voice are:

64 Kbps (PCM) / 1.544 Mbps = 24 simultaneous calls on a T1

32 Kbps (ADPCM) / 1.544 Mbps = 48 simultaneous calls on a T1

8 Kbps (CELP) / 1.544 Mbps = 120 simultaneous calls on a T1

Efficiency is the primary WAN connection issue. Bandwidth use and voice compression play an important role in provisioning the WAN.

## Recording VoIP Phone Calls

With the existing call-recording tools, you can record and save your VoIP calls and conversations.

### Call-Recording Tools

There are many simple ways of recording your phone conversations. The simplest way of all is to record it naturally by having your voice set to loudspeaker, but this does not offer quality and convenience. You can also buy one of those gadgets that record phone conversations either directly through your phone set or sound card, capturing 'whatever you hear and say', but all these are very limited.

### Requirements for Recording Phone Calls

You don't need much to record phone calls on VoIP. Here is a list of what it takes:

1. A VOIP service, be it hardware-based or a softphone
2. Hearing and speaking devices, like handsets, phones, or simply headsets
3. Call-recording tools. If you are in a corporate environment and have a PBX, you should have

business tools, else there are plenty of personal call-recording tools.

4. Storage media for storing the saved calls, like hard disks or optical disks.

## Voice Quality

Over the years voice quality has been very subjective: picking up the phone and listening to the quality of the voice. If you had two different users on the same call, you may even receive reports of varying results. After years of research, human behavioral patterns have been recorded and scored, establishing an objective measurement of call quality. The leading subjective measurement of voice quality is the Mean Opinion Score (MOS) as defined in the International Telecommunications Union (ITU) recommendation P.800. Mapping between network characteristics and quality score make MOS valuable for performing network assessments and tuning. A MOS score can range from 5 (very satisfied) to 1 (not recommended), but keep in mind that each voice codec has a benchmark score based on several factors, including packetization delay and the inherent degradation that occurs when converting the voice to a digital signal. The highest MOS rating any codec could receive is 4.5. Each codec is given a MOS value based on any known impairments for the speed of the conversion, speech quality, and data loss characteristics. Below is a listing of the most common codecs used today for VoIP and their theoretical maximum MOS value.

Each network will have a different MOS value based on QoS, delay and codec that is deployed in the IP network. When deploying an IP telephony network the goal is to get the network to support the maximum MOS value and to achieve the best quality for voice traffic. All MOS values above 4.0 are considered to be toll quality speech.

## Converting Voice into Data Packets

Digital signal processors (DSP) – the engines for voice coders – are making their way into IP telephony systems. The DSP is a specialized processor that has been in use for many years in other telephone applications such as mobile wireless networks. The DSP needs to be very fast due to the computation intensive operations required to process a typical telephone call. In essence, the DSP is what converts analog voice signals into data packets so they can be transported over an IP-based network. In this document, the term DSP refers to the combined efforts of DSPs and codecs to perform the conversion of analog and digital signals into IP communication flows. The DSP works by clarifying or standardizing the levels or states of a digital signal. A DSP circuit is able to differentiate between human-made signals, which are orderly, and noise, which is inherently chaotic. Typically, the voice-coding algorithm used for IP telephony or VoIP in a LAN environment is G.711, which divides a voice stream up into 64 Kbps packet increments. It is regarded as toll quality. Some of the other more widely available voice coding algorithms/compressors on the market are the G.729a and G.723 codecs. The G.729a and G.723 codecs are normally used for WAN connections where bandwidth is at a premium and voice compression is a requirement. The majority of vendors who support IP telephony recommend the G.729a codec due to its superior quality over G.723, making it the de facto standard for WAN connections running IP telephony.



# Buffering and Error Checking

Due to the bursty nature of business applications, data networks have large buffers built into them to sustain large bursts of traffic over a short period of time.

Large buffers in a voice network will only increase the delay of time sensitive traffic and cause poor call quality. Voice is very similar to constant bit rate (CBR) traffic – it requires a predictable, reliable throughput.

The majority of the LAN protocols used to transport data traffic includes end-to-end error checking. Therefore, if a packet is delayed or lost, the originating station will retransmit a copy of the frame. The end station will wait for the acknowledgement, then reassemble the packet stream, and pass it on to the application. This is usually transparent to the user.

Voice transmissions on the other hand are very time sensitive. The originating station does not copy the transmitted frame into a buffer, since it would only increase the delay and degrade quality. With voice, if you lose a frame, it is lost. Both error and frame sequence checking are done at the upper level of the Real Time Protocol (RTP), but due to the time sensitive nature of the voice stream, if the frame is out of sequence it will be discarded and the next frame will be processed, thus affecting the quality of the call.

The majority of voice codecs can support minor frame loss, but the conversation will be choppy and of poor quality. Some of the IP telephony equipment manufacturers have tried to compensate for poor line quality by playing the preceding voice frame a second time, but this does not resolve the issue, it only makes it tolerable. This is why it is so important to understand the inherent behavior of voice running on a data network and the additional requirements like QoS and predictive delay that a network must meet.

# IP Telephony/VoIP Audit

An IP telephony/VoIP audit should be performed for every proposed LAN/WAN segment before the addition of IP telephony traffic. The key to designing an IP telephony network is an understanding of the underlying technology used to transport the IP telephony traffic. The design principles used to deploy a successful LAN based VoIP network will not necessarily work when you apply them to a WAN configuration, due to a number of factors including limited bandwidth. QoS and traffic isolation are the key factors for the LAN, but bandwidth, priority, and delay are important to the WAN. This can make a significant impact on the installation.

The most common cause for poor voice quality during a VoIP installation is inadequate WAN bandwidth to support both voice and data traffic. If an audit was performed before the installation, corrective action could have been taken to resolve the issue before deployment.

In some cases, a poorly designed WAN can be fixed by lowering the delay with fewer router hops, setting up QoS on the routers or increasing the amount of available bandwidth prior to the installation of voice. In other cases, the solution may be too expensive or too complex and other products like bandwidth managers must be deployed before the addition of voice.

# Bandwidth Management

If the MOS value is not in an acceptable range after completing the IP audit and tweaking the installed vendor's suggested parameters, a bandwidth manager may be needed for a successful installation. Bandwidth managers allow the end user to define how much bandwidth is going to be used by each application and guarantee what percentage of the WAN bandwidth is going to be used by voice applications.

## QoS for VoIP

Voice quality is directly affected by many factors that can be divided into five QoS dimensions that affect the end user experience:

- 1) Availability
- 2) Throughput (both committed and burst)
- 3) Delay or latency
- 4) Delay variation, including jitter and wander
- 5) Packet loss

### Availability

Availability is the percentage of time that the network is up. The traditional benchmark for a voice network is 99.999% ("five 9s"), or about 5.25 minutes of downtime per year. Availability is achieved through a combination of equipment reliability and network survivability. Availability is a probability calculation, so it is not simply calculated by summing the MTBF figures.

### Throughput

Throughput is the amount of traffic – or bandwidth – delivered over a given period of time. Generally speaking, in the LAN environment, more throughput is better. For the majority of WAN users, throughput depends on the amount of money paid to lease carrier facilities. Therefore, efficiency, compression, and bandwidth management play key roles in designing an IP telephony network.

## Delay

Delay or latency is the average transit time of a service from the ingress to the egress point of the network. Many services – especially real-time services such as voice communications – are highly intolerant of excessive or unnecessary delay. Interactive conversation becomes very cumbersome when delay exceeds 100-150 ms; when it exceeds 200 users find it disturbing and describe the voice quality as poor. To provide high quality voice, the VoIP network must be capable of guaranteeing low latency. The ITU-T G.114 recommendation limits the maximum acceptable round trip delay time to 300 ms between the two VoIP gateways (150 ms one-way delay). There are many components of delay in a network that must be understood, including packetization delay, queuing delay, and propagation delay.

- **Packetization delay** is the amount of time it takes the codec to complete the analog to digital conversion. Realize that IP telephony/VoIP always creates some measure of delay, as the algorithm specifies to "listen" or sample the voice for a specified period, followed by packetization.

- **Propagation delay** is the amount of time it takes information to traverse a copper, fiber, or wireless link. It is also a function of the speed of light, the universal constant, and the signaling speed of the physical medium. For example, if a call has to pass through a transit node more delay is introduced.

- **Queuing delay** is imposed on a packet at congestion points when it waits for its turn to be processed while other packets are sent through a switch or wire. For example, ATM mitigated queuing delay by chopping packets into small pieces, packing them into cells, and putting them into absolute priority queues. Because the cells are small, the highest priority queue can be serviced more often, reducing the wait time for packets in this queue to deterministic levels. At gigabit speeds, however, the waiting time for high-priority traffic is very small even under the worst conditions, due to the speed of the links and available processing power.

# **Deploying IP Telephony and VoIP in a Multi-Vendor Environment**

Even though IP telephony and VoIP technology have made some vast reliability and quality improvements over the past couple of years, customers and network designers still struggle with implementing the technology in a multi-vendor network. There are many reasons for this, such as interoperability issues, proprietary protocols, and just plain old finger pointing. Please check with the manufacturer of your installed equipment for their recommendations on how to design and deploy an IP telephony or VoIP network in a multi-vendor setting.

# Chapter: 4

## Conclusion

There is still some development to be done in the subject. There is still much confusion on what should be the best standard and what protocols should be used. Interconnection of protocols is not always as easy as it appears to be. Many of them still lack some features or have certain disadvantages that are difficult to be conquered. Also fast internet (Broadband) or even VoIP services (For companies who can supply VoIP as a replacement for the normal phone line) is not widely deployed, many areas around the world still rely on the 56Kbps modems which, may work, but are far from being a replacement for a normal land line. Security being another point, VoIP, still early in development, does not support much security at the moment and there is still much work to be done on how to safely secure a connection between to endpoints and at the same time provide good quality and no jitter or delay, not to mention that fact that, being a digital service, it facilitates 3rd party intrusion by network hackers and more experienced users. This, in part, can be solved by network/internet companies offering QOS (Quality of Service) but that also is still early in development and not widely spread. As far as replacing the common land lines, VoIP opens up a whole new world of possibilities but being still early in development, it still needs a few years to grow and mature.

# References

[http://www.cisco.com/en/US/products/ps10326/products\\_user\\_guide\\_list.html](http://www.cisco.com/en/US/products/ps10326/products_user_guide_list.html)

[http://<ip\\_address>/display.bmp](http://<ip_address>/display.bmp)

<http://cisco.internect.net>

<http://cisco.internect.net/weather.php>

<http://cisco.internect.net/postcode.php>

<http://cisco.internect.net/news.php>