

# East West University



B.Sc. ENGINEERING THESIS

---

Design of a High speed hyperbolic and Gaussian pulse generators with electro-optic modulators based on different bit sequences for the digital fiber optic communication link

---

***Authors:***

Sadi Muhammad (2017-2-55-014)

Md. Jobayer Hossain Vuiya (2017-2-55-018)

***Supervisor:***

Zahidur Rahman

Lecturer, Dept of ECE

East West University

***This thesis has been submitted for the requirement of partial fulfillment of the degree of Bachelor of Science in Electronics and Communications Engineering***

February 6, 2022

**Design of a High speed hyperbolic and Gaussian  
pulse generators with electro-optic modulators based  
on different bit sequences for the digital fiber optic  
communication link**

## Author's Declaration

We, Sadi Muhammad and Md. Jobayer Hossain Vuiya, hereby, declare that this thesis titled “Design High speed hyperbolic and Gaussian pulse generators with electro-optic modulators based on different bit sequences for the digital fiber optic communication link” and the work presented in this thesis is the outcome of the investigation performed and authentically prepared by us under the direct supervision of Zahidur Rahman, Lecturer, Department of Electronics and Communications Engineering, East West University. We confirm that this dissertation was conducted entirely while applying for a Bachelor of Science degree in Electronics and Communications Engineering at this university. We state that the source is often specified where we have referenced from other people's work. We also declare that no part of this thesis has been or is being submitted elsewhere for the award of any other degree.

Signature,

---

Date: February, 2022

Sadi Muhammad

ID: 2017-2-55-014

Department of Electronics and  
Communications Engineering,  
East West University

Signature,

---

Date: February, 2022

Md. Jobayer Hossain

ID: 2017-2-55-018

Department of Electronics and  
Communications Engineering,  
East West University

Supervisor Signature,

---

Zahidur Rahman

Lecturer

Department of Electronics and  
Communications Engineering,  
East West University

## **Acknowledgement**

All praise is due to Allah, the Almighty, the Lord and Sustainer of the worlds, for His goodness, mercy, and blessings. We would like to express our sincere devotion and gratitude to our Almighty, the most benevolent and merciful beneficent creator, for enabling us to conduct this research and submit the study on time.

We are honored to express our sincere gratitude and appreciation to our respected mentor, Zahidur Rahman, Lecturer at East West University's Department of Electronics and Communications Engineering. He guided us throughout the study period with his constant support, technological advice, and useful guidance. He provided unwavering support and encouragement throughout the dissertation's duration, providing scholastic observation, a coherent strategy, encouragement, constructive criticisms and suggestions, relentless motivation, unflinching support, and heartfelt appreciation. Without his assistance, constant advice, and unflinching encouragement, we would be unable to complete this thesis work.

We would like to express our gratitude to all of the teachers and staff at East West University's Electronics and Communications Engineering department for their guidance and cooperation throughout the study period. As a result, we owe gratitude to everyone with whom we collaborated on the research process, though their individual contributions cannot be overlooked.

Finally, we would like to express our heartfelt appreciation and appreciation to our family, close friends, and loved ones who provided continuous assistance, knowledge, motivation, support, and guidance throughout the completion of this thesis document.

## **Abstract**

The study outlines the simulation of two pulse generators for the enhancement of optical fiber access transmission networks with flow rates of 5 and 10 Gbps and transmission ranges of 50 km, 100 km, and 150 km. Gaussian and hyperbolic secant pulse generators are used. For effective transmission, the proposed pulse generators are combined with both an electro-absorption modulator (EAM) and a Mach-Zehnder modulator (MZM). For various bit sequences, we compared the maximum quality factor with length. In the best situations for different bit sequences, the signal power amplitude is measured for both optical fiber and PIN photodetector using optical time-domain visualizer and RF spectrum analyzer. It is observed that for various bit sequences, the Gaussian pulse generator/EAM has shown an efficient rise in Q factor value as compared to proposed pulse generators/MZM.

**Keywords:** Gaussian, Hyperbolic secant, Optical modulators, Pulse generator (PG)

## Table of Contents

<b>Contents</b>	<b>Page no.</b>
Title	1
Author's Declaration	2
Acknowledgements	3
Abstract	4
Table of Contents	5
List of chapters	6-8
List of Figures	9-10
List of Tables	11
List of Abbreviations	12
List of Symbols	13

## List of chapters

---

### Chapter-1 (15-17)

---

#### Introduction

1.1 Basic and Background	15
1.2 Related work	17
1.3 Thesis Objectives	17
1.4 Thesis Outlines	17

### Chapter-2 (18-35)

---

#### Optical fiber communication system and Details

2.1 Optical fiber communication system and its components	18
2.1.1 Optical fiber communication	
2.1.2 Attenuation	
2.1.3 Dispersion	
2.1.3.1 Model dispersion	
2.1.3.2 Material dispersion	
2.1.3.3 Waveguide dispersion	
2.1.3.4 Polarization mode dispersion	
2.1.3.5 Chromatic dispersion	
2.1.4 Wavelength	
2.2 Pulse Generators	23
2.2.1 Block diagram of pulse generator	
2.3 CW laser	25

2.4 Optical Modulator	25
2.4.1 Mach-Zehnder modulator	
2.4.2 Electro absorption modulator	
2.4.3 Chirp factor	
2.5 Filters	28
2.5.1 Classification of filters	
2.5.1.1 Active filter	
2.5.1.2 Passive Filter	
2.5.2 Application of filters	
2.5.3 Bessel filter	
2.6 Photodetector	30
2.6.1 PIN Photodetector	
2.6.2 PIN photodetector characteristics	
2.6.2.1 Quantum Efficiency	
2.6.2.2 Responsivity	
2.6.2.3 Speed of response and bandwidth	
2.6.2.4 Dark current	
2.6.2.5 Noise-Equivalent Power (NEP)	

---

**Chapter-3** (36-59)

**Design and Simulation**

3.1 OptiSystem Introduction	36
3.2 Model & Method	36
3.3 Variables	37
3.4 Simulation study	38



**Chapter-4** (60-73)

---

**Results and Analysis**

4.1 Result of all the possible simulation based on hyperbolic and Gaussian PG	60
4.2 Analysis figures of different bit sequence based on all the simulations	64
4.2.1 Maximum quality factor	
4.2.2 Optical power	
4.3 Observation & Discussion	72
4.4 Comments on result	73

**Chapter-5** 74

---

**Conclusion**

5.1 Conclusion	74
5.2 Purpose of the work	74

**References** (75-77)

---

## List of Figures

---

- Figure-1.1 Working of fiber-optic communication.
- Figure-1.2 Transmitter section in optical fiber communication.
- Figure-1.3 Channel of optical fiber communication.
- Figure-1.4 Receiver section in optical fiber communication.
- Figure-2.1 Diagram of a basic fiber communication link.
- Figure-2.2 Polarization Mode Dispersion.
- Figure-2.3 Chromatic Dispersion.
- Figure-2.4 Block Diagram of a Pulse Generator.
- Figure-2.5 Block diagram of how a basic diode pumped solid state CW laser works.
- Figure-2.6 Mach-Zehnder modulator structure.
- Figure-2.7 Filter.
- Figure-2.8 Block Diagram of Filter Circuit.
- Figure-2.9 Simple Photodetector.
- Figure-2.10 Work method of a photodetector.
- Figure-2.11 PIN photodetector.
- Figure-2.12 Reversed biased of PIN Photodiode.
- Figure-2.13 Responsivity vs wavelength graphical representation.
- Figure-2.14 Photodetector Bandwidth.
- Figure-2.15 Normalized response vs frequency.
- Figure-3.1 Proposed simulation Model.
- Figure-3.2 OptiPerformer simulation model.
- Figure-3.3 Optical Power Meter.
- Figure-3.4 Optical Time Domain Visualizer.

Figure-3.5 RF Spectrum Analyzer.

Figure-3.6 BER Analyzer.

Figure-4.1 Maximum quality factor versus various propagation distance based on 4 bits sequence value of 1010 for (a) Gaussian PG/EAM (b) Gaussian PG/MZM (c) Hyperbolic Secant PG/EAM (d) for Hyperbolic Secant PG/MZM.

Figure-4.2 Maximum quality factor versus various propagation distance based on 8 bits sequence value of 10101100 for (a) Gaussian PG/EAM (b) Gaussian PG/MZM (c) Hyperbolic Secant PG/EAM (d) for Hyperbolic Secant PG/MZM.

Figure-4.3 Maximum quality factor vs flow rate vs various propagation distance based on 4 bits sequence value of 1010 for (a) Gaussian PG/EAM (b) Gaussian PG/MZM (c) Hyperbolic Secant PG/EAM (d) for Hyperbolic Secant PG/MZM.

Figure-4.4 Maximum quality factor vs flow rate vs various propagation distance based on 8 bits sequence value of 10101100 for (a) Gaussian PG/EAM (b) Gaussian PG/MZM (c) Hyperbolic Secant PG/EAM (d) for Hyperbolic Secant PG/MZM.

Figure-4.5 Optical power versus various propagation distance based on 4 bits sequence value of 1010 for (a) Gaussian PG/EAM (b) Gaussian PG/MZM (c) Hyperbolic Secant PG/EAM (d) for Hyperbolic Secant PG/MZM.

Figure-4.6 Optical power versus various propagation distance based on 8 bits sequence value of 10101100 for (a) Gaussian PG/EAM (b) Gaussian PG/MZM (c) Hyperbolic Secant PG/EAM (d) for Hyperbolic Secant PG/MZM.

## List of Tables

---

Table 3.1	Variables for the study	37-38
Table 4.1	This is the data table of Hyperbolic pulse generator based on 4 and 8-bit sequence on various modulators, fiber length, speed & attenuation.	60-62
Table 4.2	This is the data table of Gaussian pulse generator based on 4 and 8-bit sequence on various modulators, fiber length, speed & attenuation.	62-64

## List of Abbreviations

---

<b>BER</b>	<b>Bit Error Rate</b>
<b>DPSK</b>	<b>Differential Phase Shift Keying</b>
<b>EAM</b>	<b>Electro absorption Modulator</b>
<b>MZM</b>	<b>Mach-Zehnder Modulator</b>
<b>PG</b>	<b>Pulse Generator</b>
<b>LED</b>	<b>Laser</b>
<b>SNR</b>	<b>light-emitting diode</b>
<b>PMD</b>	<b>Polarization mode dispersion</b>
<b>DGD</b>	<b>differential group delay</b>
<b>CW</b>	<b>Continuous Wave</b>
<b>CATV</b>	<b>community antenna television</b>
<b>WDM</b>	<b>Wavelength Division Multiplexing</b>
<b>SONET</b>	<b>Synchronous Optical Network</b>
<b>NEP</b>	<b>Noise-Equivalent Power</b>
<b>VOA</b>	<b>Variable optical attenuators</b>
<b>DCI</b>	<b>data center interconnect</b>

## List of Symbols

---

$\alpha$	total attenuation coefficient
%T	is the percentage optical power transmission
R	is the reflection coefficient at the air-semiconductor surface
$\xi$	is the fraction of the e-h pairs contributes to the photo current
$\omega$	is the distance where optical power is absorbed
$\rho$	responsivity
$\lambda$	wavelength
$\eta$	is the quantum efficiency

*Dedicated To Our Parents .....*

# Chapter-1

## Introduction

### 1.1 Basic and Background

The technique of transmitting data from one location to another by transmitting infrared light pulses using optical fiber is known as fiber optic communication. The motivation for developing optical fiber communication systems started with the invention of the laser in the early 1960s, the use of and demand for optical fiber have grown tremendously. The uses of optical fiber today are quite numerous. With the explosion of information traffic due to the Internet, electronic commerce, computer networks, multimedia, voice, data, and video, the need for a transmission medium with the bandwidth capabilities for handling such vast amounts of information is paramount. Fiber optics, with its comparatively high bandwidth, has proven to be the solution [1]. An optical fiber communication network consists of transmitting and receiving circuit, a light source and detector device. Figure-1.1 is an illustration of a fiber-optic communication.

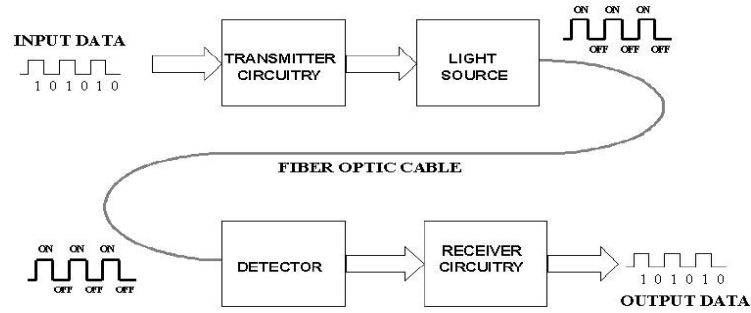


Figure-1.1 Working of fiber-optic communication.

The transmitter section includes a binary source, an electrical pulse generator, a laser diode and a modulator.

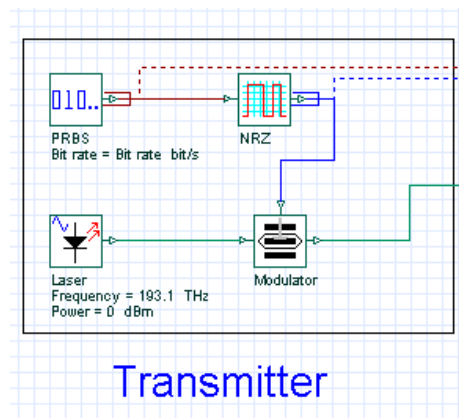
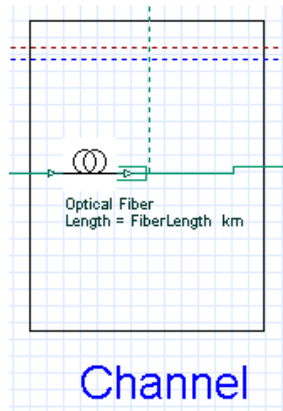


Figure-1.2 Transmitter section in optical fiber communication

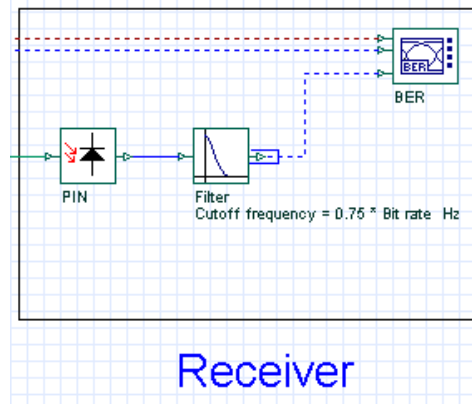


The random bit generator generates random number. There are two approaches to generate random numbers: software-based and physics-based [3]. Laser works as carrier in optical fiber communication. The pulse generators are items of electrical test equipment that generates pulses. There are different types of pulse generators in the market: Gaussian, Hyperbolic secant, Triangle, Sine, Raised cosine [2]. The high voltage pulse generators provide precision control over the output result. So, a suitable pulse generator can optimize the total data transmission. Lastly, the modulator modulates the electrical signal into optical signal. It encodes information on a carrier optic wave.



**Figure-1.3** Channel of optical fiber communication.

Through the optical fiber the light transmits between the two ends of fiber.



**Figure-1.4** Receiver section in optical fiber communication.

The receiver section includes a pin photodetector, a low pass filter and a BER analyzer. The pin photodetector converts light signals into electrical signal. As the signal was light signal so it needs to be in electrical signal for further process. The low pass filter is used to filter noise from the circuit. It allows only shorter wavelengths of light to pass through the filter. And finally, the BER is used to estimate the bit error rate of the system.

### **1.2 Related Works**

Over the last years, optical fiber has been a strong topic for researchers. There are a lot of works about various sections of this topic. There are study about using the Differential Phase Shift Keying (DPSK) modulation scheme, investigate the Bit Error Rate (BER) performance of an optical communication system [5]. At a wavelength of 1550 nm, the bit error rate performance is investigated for various fiber lengths and the number of optical amplifiers [6]. The point-to-point optical communications fiber lines were outlined in the study [1]. The various modulation formats in the L band at varying data rates impact the performance of optical communication systems [7]. To calculate the connection budget and receiver sensitivity in terms of bit error rate, BER, and Q factor for various lengths and attenuation [8]. Bit Error Rate Improvement in Fiber Optic Communications [9]. Gain and Bit Error Rate Optimization of an Erbium Doped Fiber Amplifier for Wdm System [10]. Simulation and optimization of a digital fiber optic link [11]. Through these studies we clarified many difficulties and trying to optimize optical fiber communication.

### **1.3 Thesis Objectives**

This project outlines the simulation of two pulse generators for the enhancement of optical fiber access transmission networks within flow rate of 5Gbps and 10Gbps and transmission range of 50Km, 100km, 150Km. The pulse generators are Gaussian and Hyperbolic secant. Proposed pulse generators are mixed with both electro-absorption modulator (EAM) and Mach-Zehnder modulator (MZM) for efficient transmission also the comparison between max quality factor and BER for those different lengths.

### **1.4 Thesis Outlines**

The entire dissertation is separated into five main segments.

**Chapter-1** provides a brief overview and inspiration behind this study, analysis of relevant literature, research objectives, and study methodology.

**Chapter-2** is devoted to describing the basics of fiber optic communication and its various factors and components.

In **chapte-3**, the proposed simulation model structures are presented. The design and methods of the study are investigated in this segment.

**Chapter-4**, results and analysis are estimated and examined depending upon the whole dissertation and discussed briefly.

Finally **Chapter-5** finishes by reviewing the exhaustive context and including possible scopes related to this thesis.

## Chapter-2

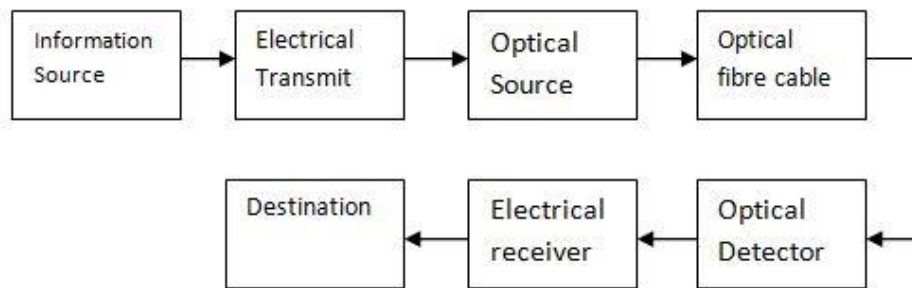
### Optical fiber communication system and Details

#### 2.1 Optical fiber communication system and its components

##### 2.1.1 Optical fiber communication

The fundamental principle of an optical fiber communication system is comparable to that of any other type of communication system. Fiber optic communication is the process of sending data from one location to another by infrared light pulses transmitted over optical fiber. The light, in this case, is in the form of a carrier signal that has been altered to include the data. When great distances, high bandwidth, and resistance to electromagnetic interference are required, fiber optic cables replace electrical wires.

Fiber-optic communication is mostly used to transmit voice, video, and telemetry through local area networks (LANs). Optical fiber is used by a large number of telecommunications firms to transport telephone, cable television, and Internet communication signals. The researchers at Bell Labs studied and established a record for the BW distance of 100 per bit kilometers per second using fiber-optic communication [13].



**Figure-2.1** Diagram of a basic fiber communication link [12].

The information source generates the electrical signal that is input. An electrical transmitter is comprised of an electrical stage that drives an optical source in order to modulate the carrier of a light wave. An Optical Source converts electrical signals to optical signals and can be either LEDs or a laser. Optical fibers are utilized as a transmission channel to compensate for transmission repeaters or optical amplifiers that incur losses. They can be used on a regular basis. Low dispersion, low fiber nonlinearity, low attenuation, a high optical signal to noise ratio, and a broad repeater span are required qualities. A detector that detects and converts optical impulses to proportional electrical signals is an optical detector. Acquisitions of photo diodes and photo transistors, for example, are sensitive at the operating wavelength, consume little power and operate at a low

voltage, have a fast response active area that matches the fiber parameter, are temperature stable, have a small size and low-cost capability of internal gain, and have low noise. Optical Repeaters and Amplifiers to compensate for signal degradation over long distances, transform an optical signal to an electrical signal, restore it, and then convert the electrical signal back to an optical signal for onward transmission. This strategy adds to the cost, complexity, and operating bandwidth of the system. Optical amplifiers simply increase the strength of the optical signal. They deliver increased SNR as a result of all optical domain actions. Fiber couplers and connectors are used to distribute light from a central fiber to one or more branch fibers and to convert one fiber to another [13].

### 2.1.2 Attenuation

The basic function of fiber optics, which is required for a variety of applications, is to transmit light efficiently at the operational wavelength(s) (e.g., long-haul telecommunications, fiber lasers, optical delivery for surgical or biomedical applications). Attenuation is the term used to describe the decrease in the intensity of light as it propagates along a fiber. Due to the limited attenuation of every optical fiber, fiber system design must account for signal strength deterioration using techniques such as signal amplification, connection optimization, fiber geometry design, and environmental isolation. Understanding attenuation processes and the possibility of reducing them is critical for the efficient and economical usage of fiber optics. Any process that results in a decrease in the measured light intensity after it has passed through a material contributes to the reported optical attenuation. In principle, all attenuation processes can be traced back to the glass's multi length scale structure (e.g., atomic structure, point defects, and second-phase inclusions) or to structures resulting from the fiberization process and/or the fiber's optical design (e.g., interfacial structure at the core-clad interface, uniformity of core clad structure along fiber length). Thus, the fundamental method for reducing attenuation in the completed fiber is to manage the material structure (through composition, material processing, and fiber production parameters). However, an understanding of the underlying optical phenomena at work and their link to the composition and structure of the material is required. The overall optical throughput (transmission) of an optical fiber can be quantified in terms of the input optical power,  $P(0)$ , and the output power,  $P(z)$  observed after light propagates a total distance  $z$ , along the fiber length total  $z$ : [14]

$$P(z) = P(0)e^{-\alpha_{total}z} \quad (1)$$

$$\%T = \frac{P(z)}{P(0)} \quad (2)$$

Where  $\alpha_{total}$  = the total attenuation coefficient (i.e., involving all contributions to attenuation); %T is the percentage optical power transmission. Equation 1 is referred to as Beer's Law and shows that transmitted power decreases exponentially with propagation distance through the fiber. In an optical fiber transmission

context, the attenuation coefficient above is often expressed in base-10 form:

$$\alpha_{total} \left( \frac{dB}{km} \right) = \frac{10}{z} \log \left[ \frac{P(0)}{P(z)} \right] = 4.343 \alpha_{total} (km^{-1}) \quad (3)$$

### 2.1.3 Dispersion

Dispersion refers to the spread of a light pulse along the length of an optical fiber. Dispersion limits the bandwidth or ability of a fiber to convey information. There must be enough space between pulses so that dispersion can be tolerated. Bitrates must be low enough for this to happen [15].

There are five main types of dispersion in a fiber:

- Modal Dispersion,
- Material Dispersion,
- Waveguide Dispersion,
- Polarization Mode Dispersion,
- Chromatic Dispersion

#### 2.1.3.1 Modal Dispersion

Only multimode fibers exhibit modal dispersion. This occurs as a result of rays traveling in different directions through the fiber and finally arriving at the fiber's opposite end at different times. Mode is a mathematical and physical concept that describes the propagation of electromagnetic waves across a medium. In the case of fiber, a mode is the path taken by a light ray as it travels down the fiber. A fiber can support anywhere from one to one hundred thousand modes. Thus, depending on its size and quality, a fiber provides a path of travel for one or more light beams. Due to the fact that light reflects differently at different angles for distinct routes or modes, the path lengths of different modes vary [15].

#### 2.1.3.2 Material Dispersion

Different wavelengths also move at different speeds through a fiber in the same manner as,

$$n=c/v$$

where  $n$  is the refractive index of the material and  $v$  is the speed of the same wavelength in that material.

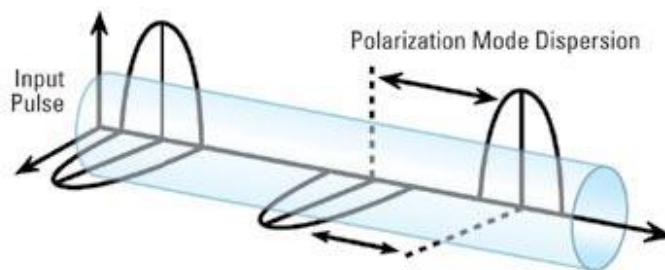
For each wavelength, the value of  $v$  in the equation varies. As a result, the refractive index varies with wavelength. The dispersion caused by this event is called material dispersion because it came from the fiber's material qualities [15].

### 2.1.3.3 Waveguide Dispersion

In a single-mode fiber, waveguide dispersion is most pronounced. This arises as a result of optical radiation passing between the core and cladding, which have slightly differing indexes of refraction. Due to the variation in refractive index of the materials, energy travels differently in the core and cladding. By modifying the fiber's internal architecture, it is possible to significantly alter the waveguide dispersion, hence altering the fiber's stipulated overall dispersion [15].

### 2.1.3.4 Polarization Mode Dispersion

Polarization mode dispersion (PMD) is linked to differential group delay (DGD), which is the time difference between two orthogonal polarized modes' group delays. This causes pulses to spread in digital systems and distortion in analogue systems because of the time difference. Two polarization modes propagate at the same velocity in ideal circular symmetric fibers. However, no ideal circumstance exists, so a true fiber does not have a perfect circular shape and is composed of local tension. Light propagates in two polarization modes [15].



**Figure-2.2** Polarization Mode Dispersion [15]

These two local polarization modes travel at different velocities causing a pulse spreading in digital systems. The so induced DGDs vary randomly along the fiber and in time, leading to a statistical behavior of PMD, both in time and wavelength. At a given time, the DGD values vary randomly with wavelength. The PMD value is the average of the DGD values. While the individual values can shift from one time to another the overall distribution, hence the average is assumed to be fixed [15].

### 2.1.3.5 Chromatic Dispersion

Chromatic dispersion is created by variances in the delay between the group velocities of the various wavelengths that make up the source spectrum. The chromatic dispersion has the effect of expanding the transmitted impulses.

Chromatic dispersion is mostly due to two sources: material and waveguide dispersion. The dispersion of the material happens as a result of the refractive index changing with the optical frequency. Generally, it is the dominating contributor, except in the wavelength region when it is absent (for silica-based material this happens around 1300 nm). The dispersion of a waveguide is determined by the waveguide's dispersive qualities. A noteworthy property from a practical standpoint is that the waveguide dispersion is inversely proportional to the material dispersion in the wavelength range above 1300 nm [15].

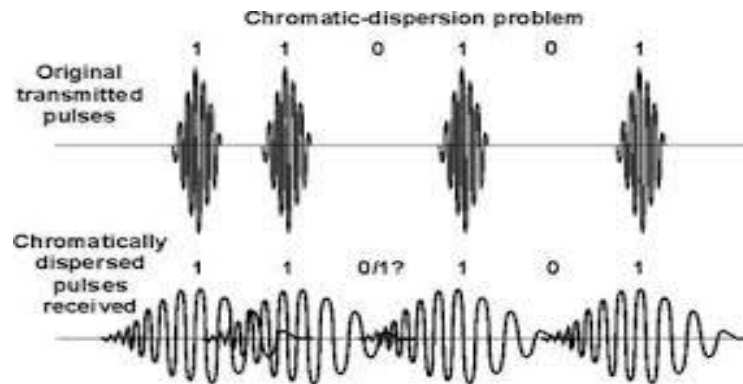


Figure-2.3 Chromatic Dispersion [15]

### 2.1.4 Wavelength

When selecting a transmission wavelength, the objective is to deliver the greatest amount of data possible across the longest distance with the least degree of signal loss. Attenuation is the term used to describe the loss of signal strength during transmission.

850, 1300, and 1550 nanometers are the three primary wavelengths utilized in fiber optic transmission. These wavelengths are employed in fiber optics because they have the least attenuation due to the fiber's low attenuation. A wave's length is proportional to its attenuation rate, the longer the wave, the less attenuation.

Attenuation can also occur as a result of something called absorption. Light signals can be absorbed by trace amounts of water vapor or metals in the glass. The majority of absorption occurs at specific wavelengths referred to as "water bands." Between the water bands are windows with the least attenuation of wavelengths. Additionally, these wavelengths are appropriate for the construction of transmission lasers and signal detectors [15].

### **2.2 Pulse Generators**

A pulse generator is a circuit or a piece of electrical test equipment that generates rectangular pulses. Pulse generators are typically utilized with digital circuits, while related function generators are typically used with analog circuits. Pulse generators typically operate between 1 Hz and 10 MHz .A calibrated linear dial will be provided. The duty cycle will be variable. Two separate output terminals will be provided. The pulse generator can operate independently of external signals or be synchronized with them [16].

#### **2.2.1 Block Diagram of a Pulse Generator**

The exhibit illustrates the block diagram of a pulse generator. The frequency control circuit maintains control over the total of the two current sources. It supplies control voltages to the bases of the two current generators' current control transistors. In the generating loop, there are two current sources: a ramp capacitor, a schmitt trigger, and a switching circuit that can change the amount of current. The current source generates a continuous current that is used to charge the capacitor (ramp capacitor). The symmetry control setting determines the ratio of these two currents. The duty cycle of the output waveform is determined by this control later. The multiplier switch is used to select the capacity of the ramp capacitor. The last two settings let you change the output frequency by a decade or by a tenth of a second. The upper current source charges the ramp capacitor at a constant rate, resulting in a linear increase in the ramp voltage. The Schmitt trigger changes states when the positive slope of the ramp voltage approaches the upper limit specified by the internal circuit components [16].



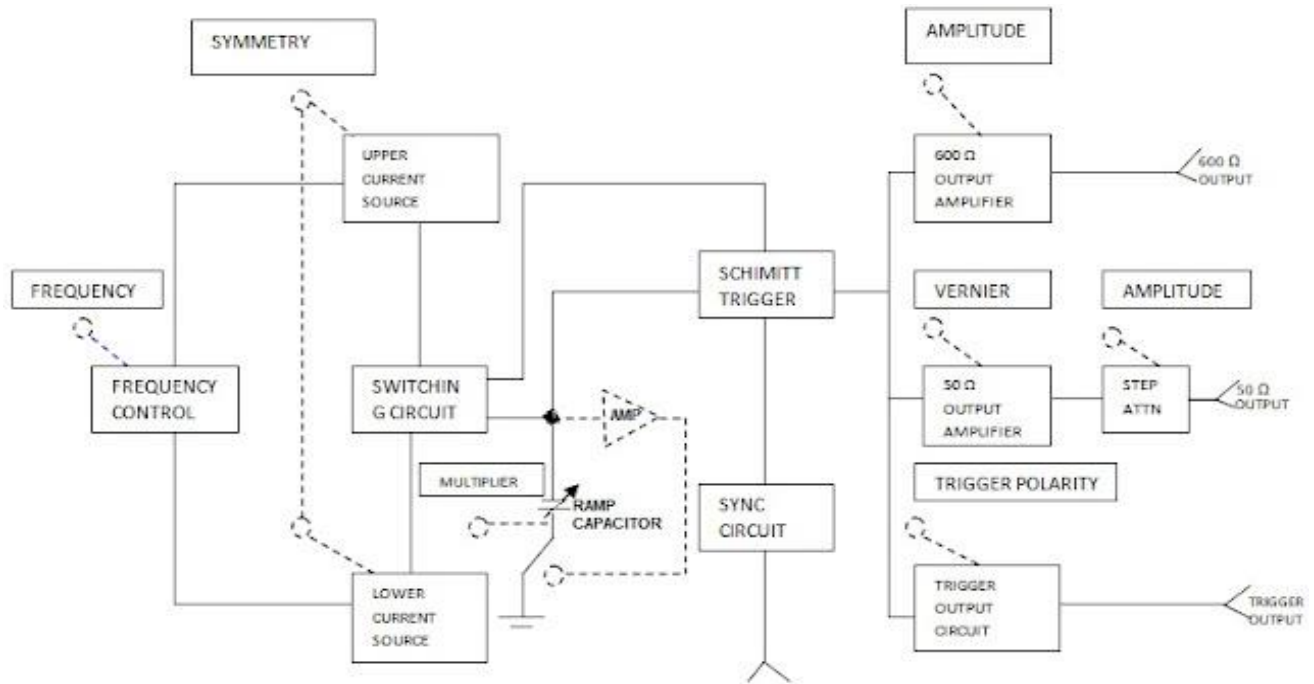


Figure-2.4 Block Diagram of a Pulse Generator [16]

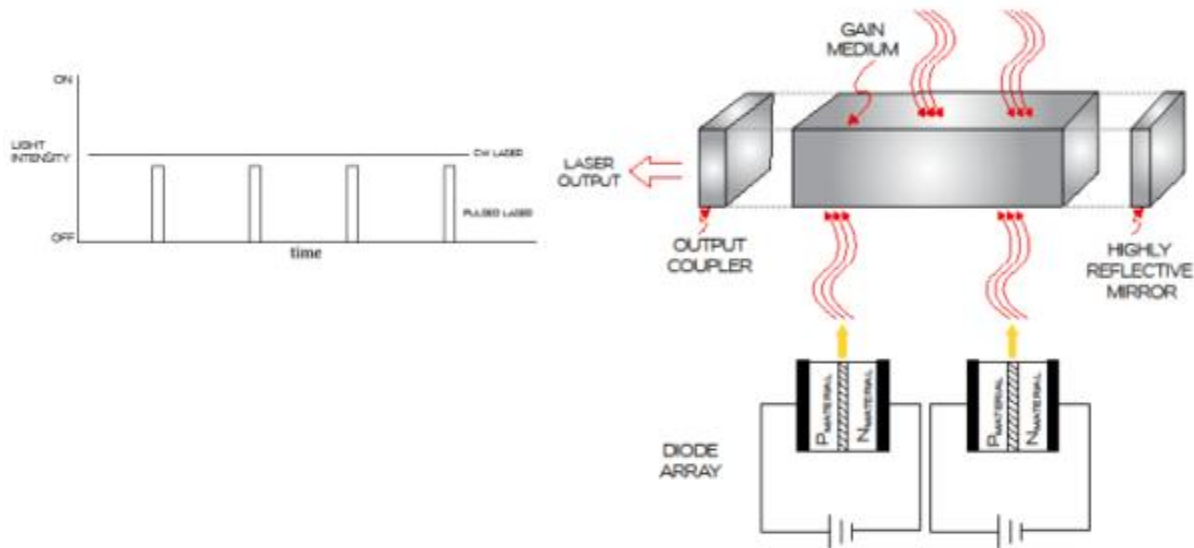
The trigger circuit's output becomes negative, reversing the current control switch's conditions, and the capacitor begins discharging. The discharge rate is linear, with the lower current source controlling it. The Schmitt trigger returns to its previous state when the negative ramp hits a predefined lower threshold. This now generates the positive trigger output, which flips the current switch's state, turning off the lower current source and re-enabling the upper current source. The current cycle of operation is complete. The procedure is repeated. The Schmitt trigger circuit generates a continuous negative pulse.

The Schmitt trigger circuit's output is routed to the trigger output circuit as well as to the 50 and 600 amplifiers. The trigger output circuit distinguishes the square wave output from the Schmitt trigger, inverts the resulting pulse, and outputs a positive triggering signal. The 60 amplifier incorporates an output attenuator, which enables precise control of the signal output voltage. Along with its free-running mode, the generator can be synchronized or locked to an external signal. This is accomplished by externally synchronizing the Schmitt trigger circuit. The power supply is a controlled power supply that powers all of the pulse generator's subsystems [16].

We used Gaussian PG and Hyperbolic PG in this work.

### 2.3 CW Laser

A continuous wave (or constant wave) laser is referred to as a CW laser. This abbreviation is used to distinguish continuous-wave lasers from pulsed lasers. A pulsed laser has an output that is programmed to switch on and off at a predetermined repetition rate. The abbreviation "CW" refers to "continuous wave". Different materials can be used to provide a continuous wave laser output. Among these materials are gas, crystals, and different semiconductors. This tutorial will discuss continuous-wave (CW) lasers generated by diode pumping solid-state materials (CW DPSS lasers) and continuous-wave (CW) fiber lasers) [17].



**Figure-2.5** block diagram of how a basic diode pumped solid state CW laser works [17]

### 2.4 Optical Modulator

A continuous wave (or constant wave) laser is referred to as a CW laser. This abbreviation is used to distinguish continuous-wave lasers from pulsed lasers. A pulsed laser has an output that is programmed to switch on and off at a predetermined repetition rate. The abbreviation "CW" refers to "continuous wave". Different materials can be used to provide a continuous wave laser output. Among these materials are gas, crystals, and different semiconductors. This tutorial will discuss continuous-wave (CW) lasers generated by diode pumping solid-state materials (CW DPSS lasers) and continuous-wave (CW) fiber lasers. Optical modulators transform electrical impulses representing data or voice into modulated optical signals in optical communication systems. An optical modulator can be used to provide the desired optical power, color, and other characteristics in passing light by modulating optical parameters such as the transmission factor, refractive index, reflection factor, degree of deflection, and coherency of light in the optical system. The majority of optical modulators are based on direct or external modulation. The optical source is turned on and off at regular intervals using direct modulation. External modulation utilizes continuous operation of the optical

source and modulation of its output light via an optical external modulator. There are several types of external optical modulators, including electro-optical modulators, magneto-optical modulators, acousto-optic modulators, and electric field absorption modulators. Optical modulators based on semiconductors have been produced utilizing a variety of different technologies and are used to modulate light for optical communications. An electro-absorption modulator is one type of semiconductor-based optical modulator. The electro-absorption optical modulator (EA modulator) is a type of optical modulator that makes use of the electro-absorption effect. A substance's coefficient fluctuates according to the electric field applied to it. The EA modulator is commonly classified into two types: those that use an absorption waveguide layer with a quantum well structure and those that use a bulk semiconductor layer in place of the waveguide layer. A Mach-Zehnder optical modulator with a branching interference type The Optical Waveguide structure is one of the optical waveguide devices that utilizes such an electro-optical crystal. Variable optical attenuators (VOA) are used to dynamically alter the optical power levels in a communication, telecommunications, or other transmission network. As network traffic grows, VOAs can be used to dynamically reduce optical power levels based on the length of the network path, ensuring that suitable power levels are received at end receivers. There are many things that could affect the performance of optical modulators, such as changes in the outside temperature [18].

### 2.4.1 Mach-Zehnder modulator

The Mach-Zehnder modulator (MZM) is an interferometric structure constructed of a material that exhibits a strong electro-optic effect (such as LiNbO<sub>3</sub>, GaAs, or InP). When electric fields are applied to the arms, the optical path lengths change, resulting in phase modulation. When two arms with varying phase modulations are combined, phase modulation is converted to intensity modulation [19].

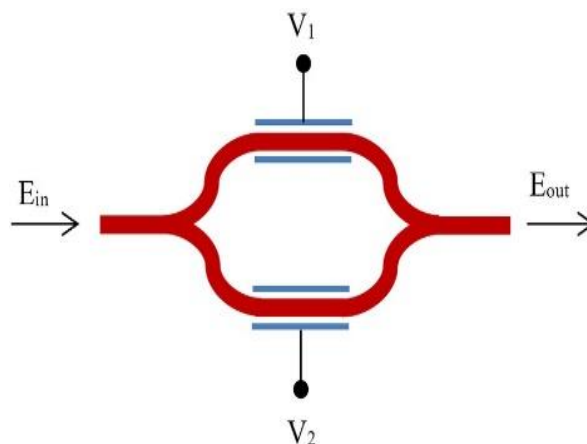


Figure-2.6 Mach-Zehnder modulator structure [19]

The optical input is divided into upper and lower modulator arms, which are phase modulated using two phase shifters powered by electrical impulses V1 and V2, and then recombined to form the optical output Out. Before delving deeper into the above implementation, let's take a look at a few MZM structures that have garnered considerable interest recently as a result of developments in data center interconnect (DCI) technology and photonic integration [19].

### 2.4.2 Electro-absorption modulator

An electroabsorption modulator (or electro-absorption modulator) is a semiconductor-based optical modulator. It can be used for controlling (modulating) the intensity (more precisely, the optical power) of a laser beam via an electric voltage (intensity modulators). Its principle of operation is based on the Franz–Keldysh effect a change in the absorption spectrum caused by an applied electric field, which changes the band gap energy (thus the photon energy corresponding to an absorption edge) but usually does not involve a substantial excitation of carriers by the electric field. Most electroabsorption modulators are made in the form of waveguides with electrodes for applying an electric field in a direction perpendicular to the modulated light beam. To achieve a high extinction ratio, one usually exploits the quantum-confined Stark effect in a quantum well structure. Compared with electro-optic modulators, electro-absorption modulators can operate at much lower voltages (a few volts instead of hundreds of thousands of volts). They can be operated at very high speeds; a modulation bandwidth of tens of gigahertz can be achieved, which makes these devices useful for optical fiber communications. A convenient feature is that an electro-absorption modulator can be integrated with a distributed feedback laser diode on a single chip to form a data transmitter in the form of a photonic integrated circuit. A higher bandwidth and reduced chirp can be obtained compared with direct modulation of the laser diode [20].

### 2.4.3 Chirp factor

In the reference article [1], the chirp factor is defined as the ratio between the modulator output frequency modulation and amplitude modulation:

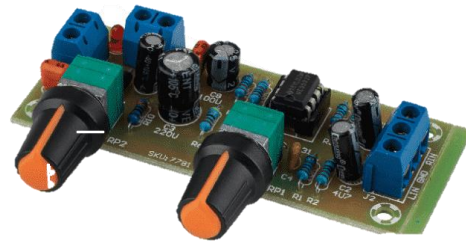
$$\alpha = \frac{\frac{d\phi}{dt}}{\frac{1}{E_{out}} \frac{dE_{out}}{dt}} \quad (4)$$

The chirp factor can be assumed to be zero in an ideal Mach-Zehnder modulator with perfect power distribution between arms and driven with opposite voltages [3]. There could be additional explanations for the chirp-like asymmetry in the construction of the upper and lower arms. The chirp factor, as defined above, is used in industry to characterize spurious frequency modulation at the modulator's output and can be directly

measured for instance.

### 2.5 Filters

Filters are essential parts of Electronic and Communication Systems because they modify the amplitude and/or phase characteristics of a signal in relation to its frequency. A filter is a simple linear circuit that assists in removing unwanted components from an input signal such as noise, interference, and distortion. Ideally, a filter modifies the relative amplitudes and phase characteristics of the various frequency components, and its 'Gain' is entirely dependent on the signal frequency [21].



**Figure-2.7** Filter [21]

A filter is defined by its frequency-domain effects on signals, which are frequently mathematically expressed in terms of its transfer function and expressed as the ratio of the Laplace Transforms of its output and input signals.

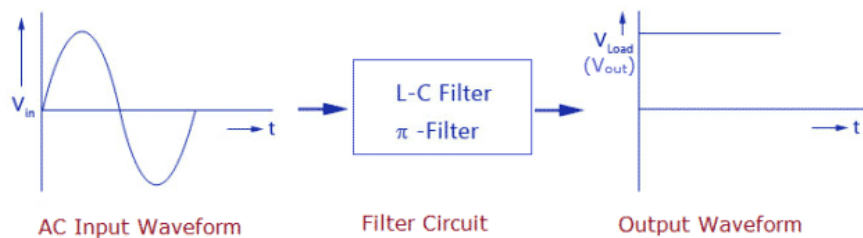
The voltage transfer function  $H(s)$  of a Filter Circuit is written as:

$$H(s) = \frac{V_{out}(s)}{V_{in}(s)} \tag{5}$$

Where,

$V_{IN}(s)$  = Input Signal

$V_{OUT}(s)$  = Output Signal



**Figure-2.8** Block Diagram of Filter Circuit [21]

### **2.5.1 Classification of Filters**

Filter is mainly classified into two types:

- Active Filter
- Passive Filter

#### **2.5.1.1 Active Filters**

Active Filter is a filter circuit that includes active components such as transistors and op-amps in addition to resistors and capacitors [21].

#### **2.5.1.2 Passive Filters**

Passive Filter is a filter circuit that is composed of passive components such as resistors, capacitors, and inductors. The operating frequency range of the filter banks on the circuit components. As a result, the filter can be classified further according to the operating frequency of a particular circuit. They are:

- Low Pass Filter
- High Pass Filter
- Band Pass Filter
- Band Stop Filter
- All Pass Filter
- Low Pass Filters

### **2.5.2 Applications of Filters**

- Filter Circuits are used to eliminate background Noise
- They are used in Radio tuning to a specific frequency
- Used in Pre-amplification, Equalization, Tone Control in Audio Systems
- They are also used in Signal Processing Circuits and Data Conversion
- Filter Circuits are extensively used in Medical Electronic Systems

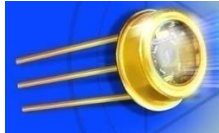
### **2.5.3 Bessel filter**

A Bessel filter is a type of analogue linear filter used in RF and other electronic applications. It has a group or phase delay that is as flat as possible. This ensures that signals within the pass-band retain their wave shape. Certain RF and, more specifically, audio applications require the wave shape and phase of signal components

to be preserved. Audio crossover units are just one type, although there are numerous others. The Bessel filter is an ideal solution for these applications.

As one might expect, the Bessel filter has a slower transition from pass-band to stop-band than other similar-order filters.

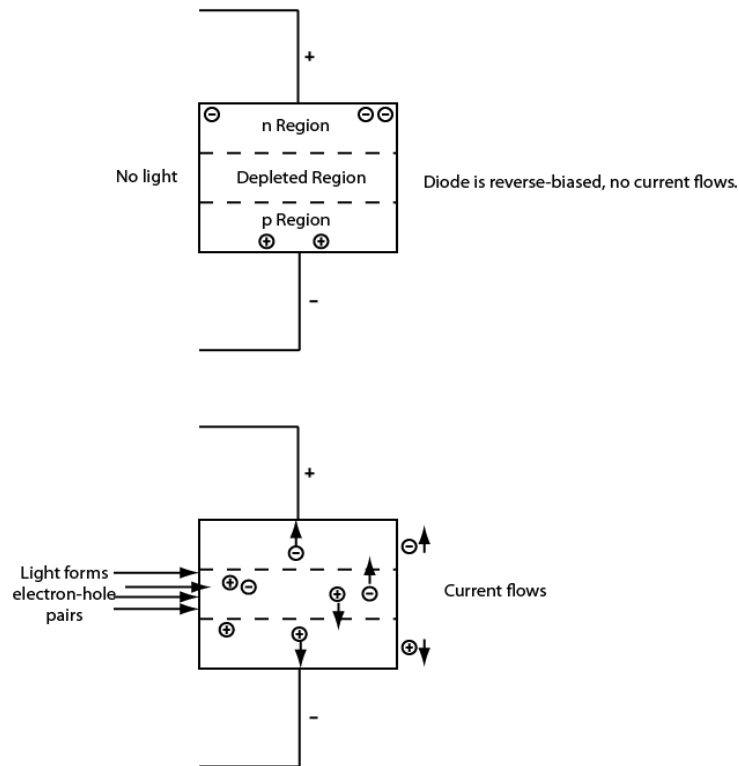
**2.6 Photodetector**



**Figure-2.9** simple Photodetector [22]

An optical detector converts light signals to electrical signals that can be amplified and processed. The photodetector is as critical as the optical fiber or the light source in any fiber optic system. Photodetectors have the ability to significantly affect the performance of a fiber optic communication link.

The following illustration shows how a photodetector work. The detector is electrically reverse-biased. (In contrary, LEDs and Lasers are forward biased to emit light) [22].



**Figure-2.10** Work method of a photodetector [22]

When no light is present, the reverse bias draws current-carrying electrons and holes out of the p-n junction region, forming a depleted region that prevents current from flowing through the diode.

When the detector is illuminated in the second illustration, photons of sufficient energy (wavelength) can form electron-hole pairs in this region by raising an electron from the valence band to the conduction band, leaving a hole behind. The bias voltage accelerates the drift of these current carriers away from the junction region, resulting in a current flow proportional to the amount of light striking the detector.

The wavelengths at which the detector responds to light are determined by the material composition of the detector [22].

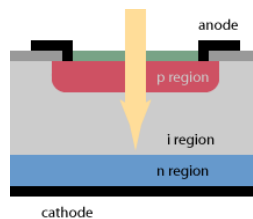
### 2.6.1 PIN Photodetector

The most common semiconductor photodetector is the PIN photodiode as shown below.



**Figure-2.11** PIN photodetector [22]

PIN photodiode has an intrinsic (very lightly doped) semiconductor region sandwiched between a p-doped and an n-doped region (as shown below).



**Figure-2.12** Reversed biased of PIN Photodiode [22]

As illustrated above, the PIN photodiode is reverse-biased. Due to the fact that the intrinsic I region contains no free charges and thus has a high resistance, the majority of the reverse-biased voltage is applied to this I region. Because the I region is typically wider than the p or n regions, incoming photons have a greater probability of absorption in the I region. Due to the high electric field in the I region, any electron-hole pairs generated in this region are swept away immediately by the field. Before E-h pairs generated in the p and n regions can be swept away, they must first diffuse into the depletion region. Additionally, these e-h pairs may be subjected to recombination, resulting in a decrease in current [22].



### 2.6.2 PIN Photodetector Characteristics

#### 2.6.2.1 Quantum Efficiency

Sensitivity quantifies the optical input signal's response as a function of its intensity. The sensitivity of a photodetector can be quantified using two concepts: quantum efficiency and responsivity.

This section will focus on quantum efficiency, while the following section will discuss responsiveness.

Quantum efficiency quantifies the fraction of photons that arrive at the detector and generate electrons. This term is defined as,

$$\text{Quantum Efficiency} = \frac{\text{Electrons output}}{\text{Photons input}}$$

Quantum efficiency is defined as the ratio of generated electron-hole (e-h) pairs to incident photons. It can be calculated using the formula

$$\eta = (1 - R)\xi(1 - e^{-\alpha\omega}) \quad (6)$$

Where,

R is the reflection coefficient at the air-semiconductor surface

$\xi$  is the fraction of the e-h pairs contributes to the photo current

$\alpha$  is the absorption coefficient

$\omega$  is the distance where optical power is absorbed

#### 2.6.2.2 Responsivity

The term "responsiveness" refers to the ratio of the detector's electrical output to the input optical power. If the output current varies proportionally to the input current, the amps per watt (A/W) value is used. Due to the fact that input powers in fiber optic communication systems are typically measured in microwatts, responsivity is frequently expressed as uA/uW.

The responsivity  $\rho$  is the photo current generated per unit optical power. The following formula shows how to calculate responsivity [22].

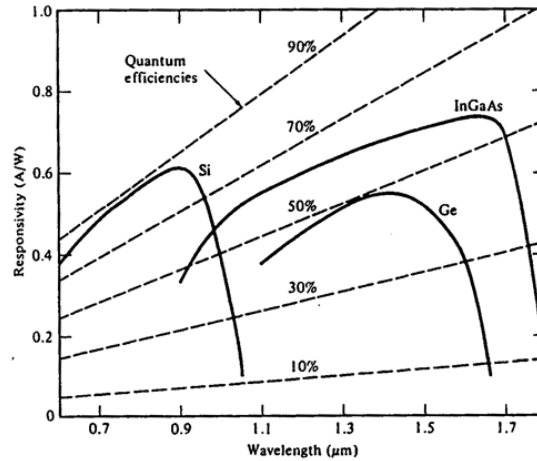
$$\rho = \frac{\lambda_0}{1.24} \eta \quad (7)$$

Where,

$\lambda_0$  is measured in  $\mu\text{m}$  (micrometers)

$\eta$  is the quantum efficiency

The following figure shows the spectral dependence of responsivity and quantum efficiency for different semiconductor materials.



**Figure-2.13** Responsivity vs wavelength graphical representation [22]

### 2.6.2.3 Speed of Response and Bandwidth

A photodetector's response time and bandwidth are determined by three factors. The time required for photo-generated carriers to traverse the depletion region. The electrical frequency response of a diode as determined by the RC time constant, which is capacitance dependent. Carriers generated outside the depletion region diffuse slowly.

#### Rise Time

Rise time is the time the output signal takes to rise from 10% to 90% of the peak value after the input is turned on instantaneously.

#### Fall Time

Fall time is the time the output signal takes to drop from 90% to 10% of the peak value after the input is turned off abruptly.

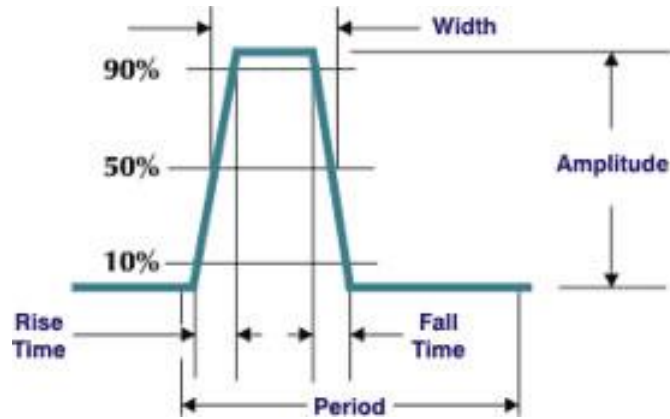


Figure-2.14 Photodetector Bandwidth [22]

The bandwidth of a detector is typically defined as the frequency at which the output signal drops to 3dB (50 percent) of its maximum power at a low frequency. This means that at the higher frequency, only half as much signal passes through the detector.

The highest frequencies in a square wave function are responsible for the sharp edges. Frequencies above the bandwidth frequency (50 percent) are further attenuated. With decreasing bandwidth, the pulses become more rounded [22].

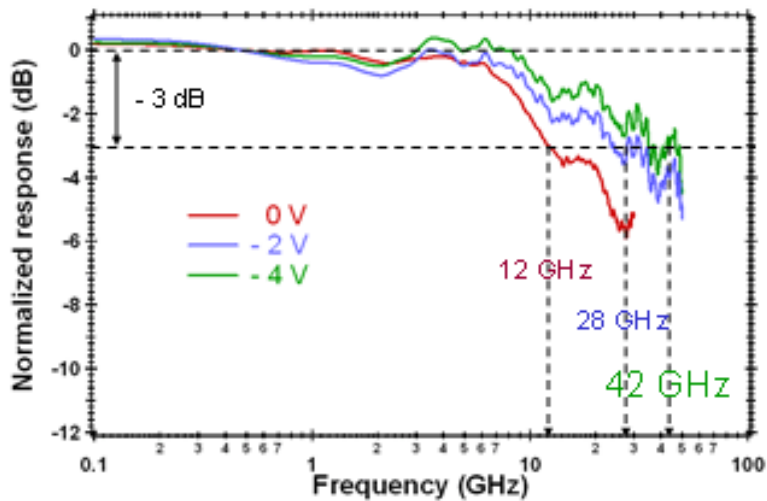


Figure-2.15 Normalized response vs frequency [22]

#### 2.6.2.4 Dark Current

When a photodiode is operated in photoconductive mode, the dark current is the current flowing through it in the absence of light. The dark current is made up of photocurrent generated by background radiation and the semiconductor junction's saturation current.

Dark current establishes a ceiling on the smallest detectable signal, as a signal must generate more current than the dark current to be detected. The dark current is dependent on the operating temperature, bias voltage, and detector type.

Dark current must be accounted for during calibration if a photodiode is used to accurately measure optical power, and it also acts as a source of noise in an optical communication system [22].

### **2.6.2.5 Noise-Equivalent Power (NEP)**

NEP is the minimum optical power required to generate photocurrent equal to the rms noise current in a 1 hertz bandwidth.

This method more precisely determines the smallest detectable signal because it directly compares noise to optical power.

NEP is dependent on the modulated signal's frequency, the noise measurement bandwidth, the detector area, and the operating temperature [22].

## Chapter-3

### Design and Simulation

#### 3.1 OptiSystem Introduction

OptiSystem is an optical communication system simulation package for the design, testing, and optimization of virtually any type of optical link in the physical layer of a broad spectrum of optical networks, from analog video broadcasting systems to intercontinental backbones. A system level simulator based on the realistic modeling of fiber-optic communication systems, OptiSystem possesses a powerful simulation environment and a truly hierarchical definition of components and systems. Its capabilities can be easily expanded with the addition of user components and seamless interfaces to a range of widely used tools. It serves a wide range of applications, from CATV/WDM network design and SONET/SDH ring design to map design and transmitter, channel, amplifier, and receiver design. OptiSystem is compatible with Optiwave's OptiAmplifier and OptiBPM design tools [4].

#### 3.2 Model and Method

Figure-1 outlines the components of the proposed model: User-defined bit sequence generator generates a bit sequence of 4 bits (1010) and 8 bits (10101100). The flow rates are 5Gbps and 10Gbps through the distance of 50km, 100km and 150Km. Two electrical pulse generators are employed that are namely Gaussian and Hyperbolic secant with the light signal that is generated from the continuous wave (CW) laser which is both injected to optical modulators. Figure-3.1 Proposed simulation Model [2].

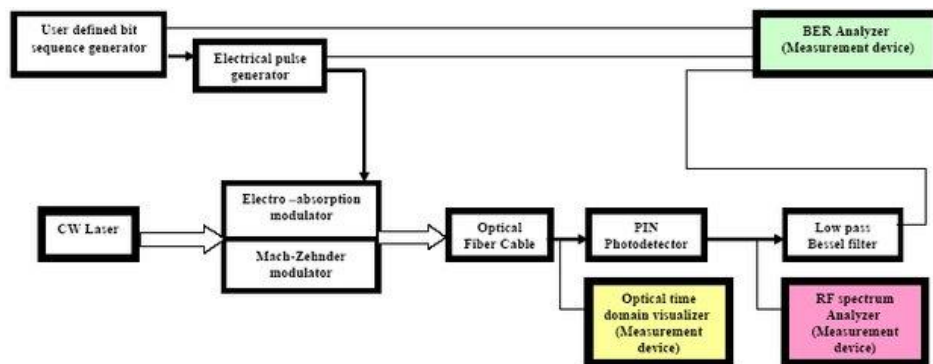
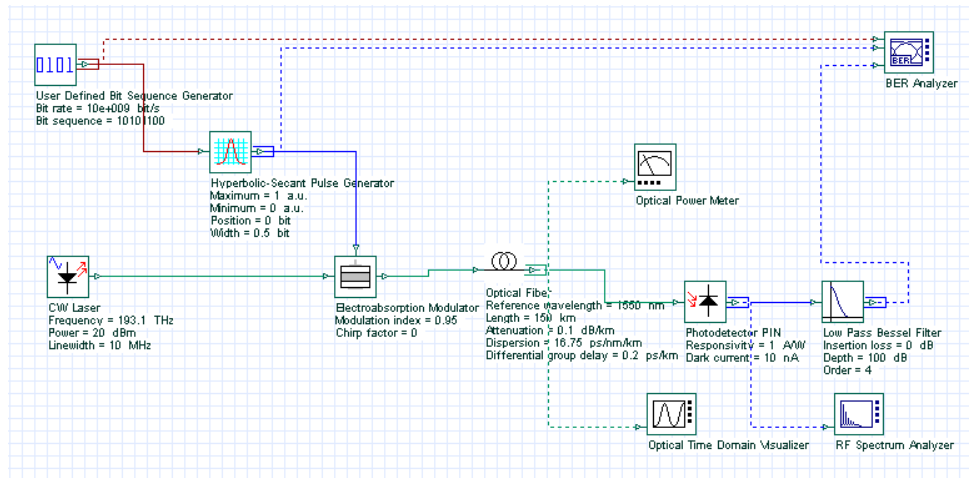


Figure-3.1 Proposed simulation Model [2].

## Chapter-3 Design and Simulation



**Figure-3.2** OptiPerformer simulation model.

The light signal is forward to fiber cable and then to PIN photodetector where electrical form can be detected. The electrical signal is fed to low pass Bessel filter which is used to remove the ripples from the signal. Both electro-absorption and Mach-Zehnder modulators are used to modulate the electrical and optical signals together. Bit error rate (BER) tests the max Q-factor value and min BER value.

### 3.3 Variables

Components	Parameter description	Value/unit
The user-defined bit sequence generator	Bit sequence	1010,10101100
Gaussian pulse generator	Amplitude	1 a.u
Hyperbolic Secant pulse generator	Bias	c0 a.u
	Width	0.5 bit
	Position	0 bit
	Order	1
CW Laser	Frequency	193.1 THz
	Power	20 dBm
	Linewidth	10 MHz
Mach-Zehnder Modulator	Extinction ratio	30 dB
	Symmetry factor	-1
Electroabsorption Modulator	Modulation index	0.95
	Chirp factor	0
Optical fiber	Reference wavelength	1550nm
	Range	50,100,150 km
	Attenuation	0.1,0.2 dB/km

### Chapter-3 Design and Simulation

	Dispersion	16.75 ps/nm/km
	Differential group delay	0.2 ps/km
Pin Photodetector	Responsitivity	1 A/W
	Dark current	10 nA
Low Pass Bessel filter	Insertion loss	0 dB
	Depth	100 dB
	Order	4

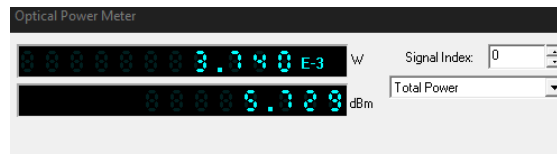
**Table-3.1** Variables for the study

#### 3.4 Simulation Study

In this section we will show our simulation part that we have done in OptiPerformer. We ran the above Figure-3.2 simulation model in Optiperfomer for Gaussian, Hyperbolic Secant pulse generator with Electroabsorption, Mach-Zehnder modulator and took the best results so that we can easily decide the suitable pulse generator over various lengths after observing those results. In Figure-3.3 we can see the optical power for Gaussian, Hyperbolic Secant pulse generator with Electro-absorption and Mach-Zehnder modulator based on 4-bit, 8-bit sequence value of 1010 and 10101100 at a transmission distance of 50km, 100km, 150km and flow rate of 5Gbps, 10Gbps.



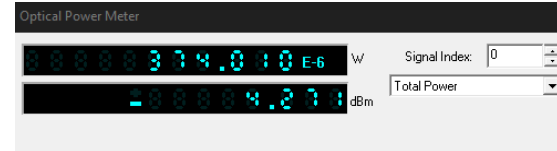
(1)



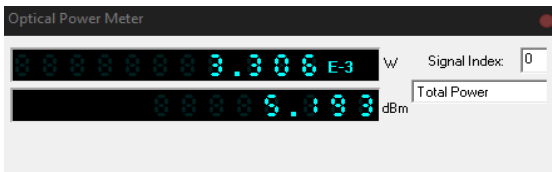
(2)



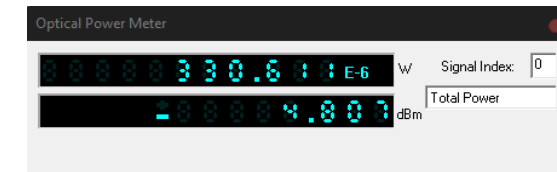
(3)



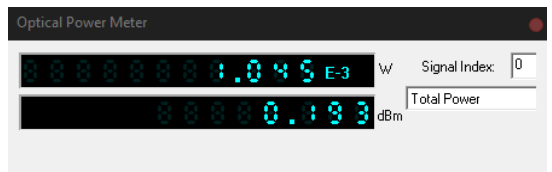
(4)



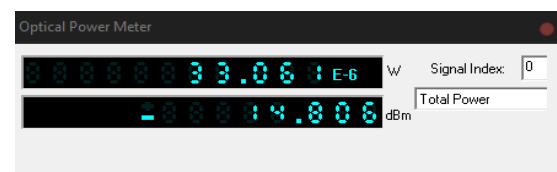
(5)



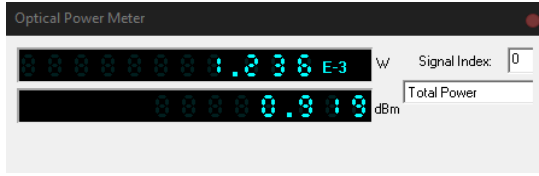
(6)



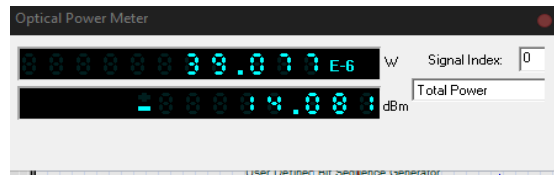
(7)



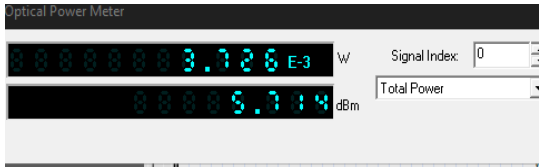
(8)



(9)



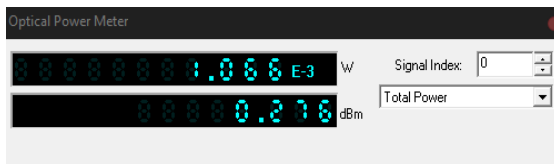
(10)



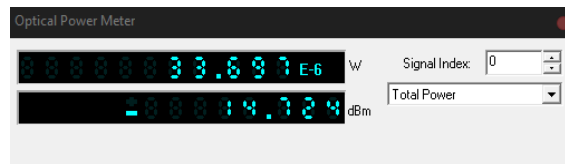
(11)



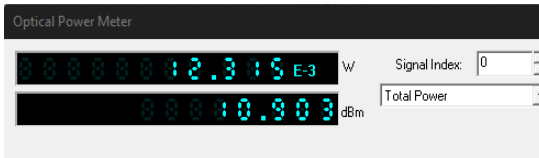
(12)



(13)



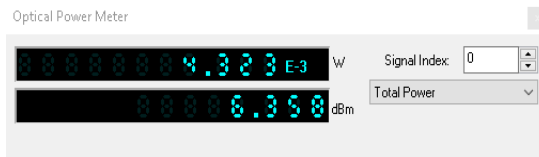
(14)



(15)



(16)



(17)



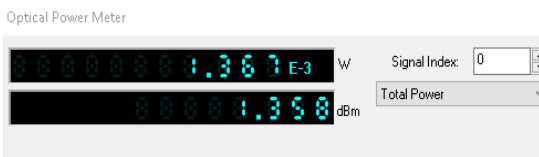
(18)



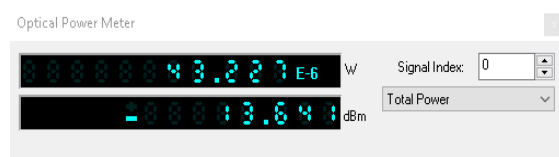
(19)



(20)

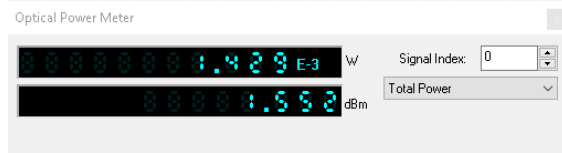


(21)

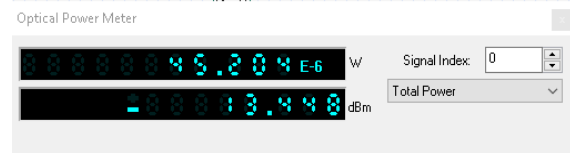


(22)

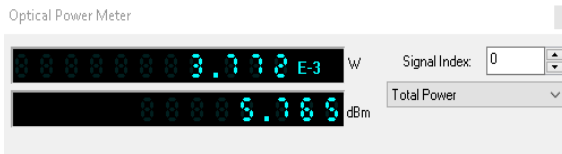




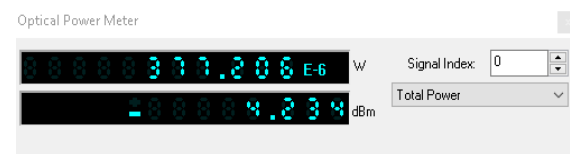
(23)



(24)



(25)



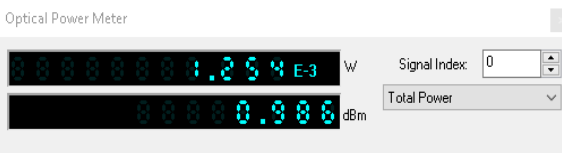
(26)



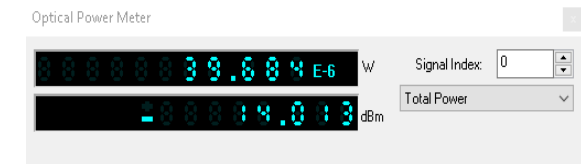
(27)



(28)



(29)

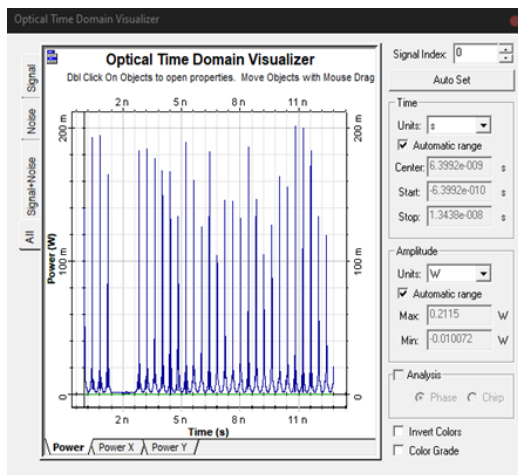


(30)

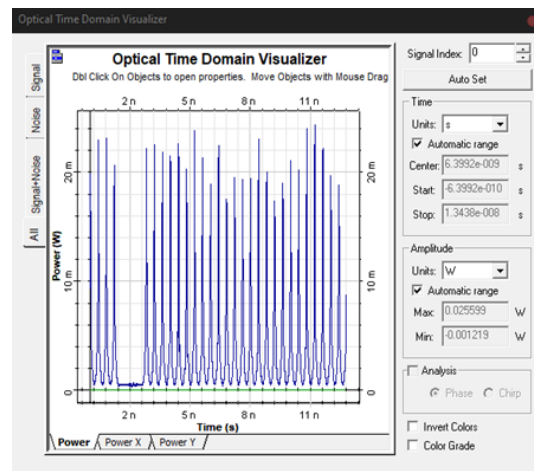
**Figure-3.3** Optical Power Meter (1) 4 Bit, 5Gbps, Gaussian pulse, Electroabsorption modulator, 50km at attenuation 0.1 (2) 4 Bit, 5Gbps, Gaussian pulse, Electroabsorption modulator, 50 km at attenuation 0.2 (3) 4 Bit, 5Gbps, Gaussian pulse, Electroabsorption modulator, 100 km at attenuation 0.1 (4) 4 Bit, 5Gbps, Gaussian pulse, Electroabsorption modulator, 100 km at attenuation 0.2 (5) 4 Bit, 5Gbps, Gaussian pulse, Mach-Zehnder modulator, 100 km at attenuation 0.1 (6) 4 Bit, 5Gbps, Gaussian pulse, Mach-Zehnder modulator, 100 km at attenuation 0.2 (7) 4 Bit, 5Gbps, Gaussian pulse, Mach-Zehnder modulator, 150 km at attenuation 0.1 (8) 4 Bit, 5Gbps, Gaussian pulse, Mach-Zehnder modulator, 150 km at attenuation 0.2 (9) 4 Bit, 10Gbps, Gaussian pulse, Electroabsorption modulator, 150 km at attenuation 0.1 (10) 4 Bit, 10Gbps, Gaussian pulse, Electroabsorption modulator, 150 km at attenuation 0.2 (11) 8 Bit, 5Gbps, Gaussian pulse, Electroabsorption modulator, 100 km at attenuation 0.1 (12) 8 Bit, 5Gbps, Gaussian pulse, Electroabsorption modulator, 100 km at attenuation 0.2 (13) 8 Bit, 5Gbps, Gaussian pulse, Mach-Zehnder modulator, 150 km at attenuation 0.1 (14) 8 Bit, 5Gbps, Gaussian pulse, Mach-Zehnder modulator, 150 km at attenuation 0.2 (15) 8 Bit, 10Gbps, Gaussian pulse, Electroabsorption modulator, 50 km at attenuation 0.1 (16) 8 Bit, 10Gbps, Gaussian pulse, Electroabsorption modulator, 50 km at attenuation 0.2 (17) 4 Bit, 5Gbps, Hyperbolic Secant pulse, Electroabsorption modulator, 100 km at attenuation 0.1 (18) 4 Bit, 5Gbps, Hyperbolic Secant pulse, Electroabsorption modulator, 100 km at attenuation 0.2 (19) 8 Bit, 5Gbps, Hyperbolic Secant pulse, Electroabsorption modulator, 100 km at attenuation 0.1 (20) 8 Bit, 5Gbps, Hyperbolic Secant pulse, Electroabsorption modulator, 100 km at attenuation 0.2 (21) 4

Bit, 5Gbps, Hyperbolic Secant pulse, Electroabsorption modulator, 150 km at attenuation 0.1 (22) 4 Bit, 5Gbps, Hyperbolic Secant pulse, Electroabsorption modulator, 150 km at attenuation 0.2 (23) 4 Bit, 10Gbps,Hyperbolic Secant pulse, Electroabsorption modulator, 150 km at attenuation 0.1 (24) 4 Bit, 10Gbps,Hyperbolic Secant pulse, Electroabsorption modulator, 150 km at attenuation 0.2 (25) 4 Bit, 5Gbps, Hyperbolic Secant pulse, Mach-Zehnder modulator, 100 km at attenuation 0.1 (26) 4 Bit, 5Gbps, Hyperbolic Secant pulse, Mach-Zehnder modulator, 100 km at attenuation 0.2 (27) 8 Bit, 5Gbps, Hyperbolic Secant pulse, Mach-Zehnder modulator, 100 km at attenuation 0.1 (28) 8 Bit, 5Gbps, Hyperbolic Secant pulse, Mach-Zehnder modulator, 100 km at attenuation 0.2 (29) 4 Bit, 10Gbps, Hyperbolic Secant pulse, Mach-Zehnder modulator, 150 km at attenuation 0.1 (30) 4 Bit, 10Gbps, Hyperbolic Secant pulse, Mach-Zehnder modulator, 150 km at attenuation 0.2

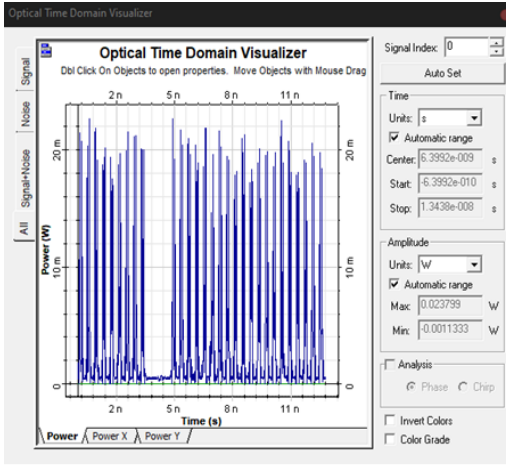
We have found that for Hyperbolic Secant pulse generator with Electroabsorption modulator in 4 Bit, 50km at 10Gbps and at attenuation 0.1 optical power is highest which is 11.553dBm and as the attenuation increases the optical power decreases. Also if we increase the length the optical power decreases. So at 150km we get the lowest optical power for both pulses. Now in Figure-3.4 we will see the optical time domain visualizer for Gaussian, Hyperbolic Secant pulse generator with Electro-absorption and Mach-Zehnder modulator based on 4-bit, 8-bit sequence value of 1010 and 10101100 at a transmission distance of 50km, 100km, 150km and flow rate of 5Gbps, 10Gbps.



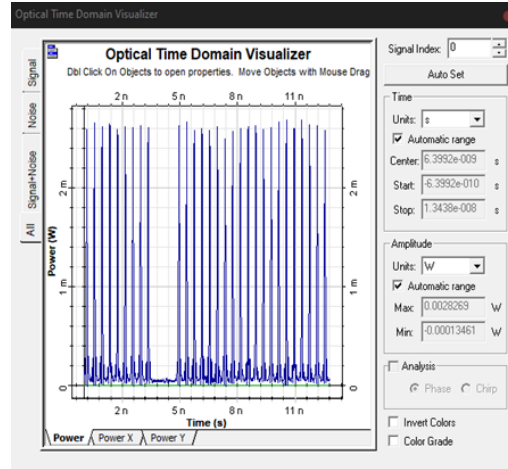
(1)



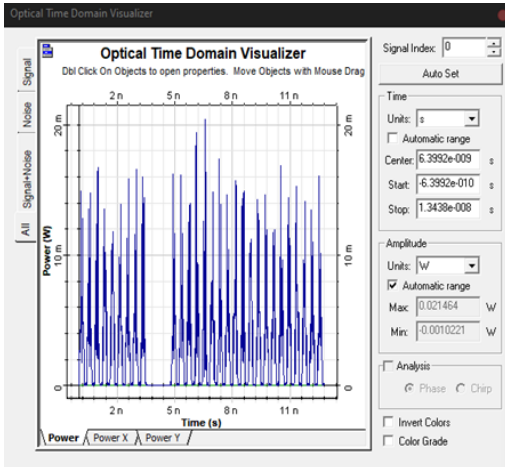
(2)



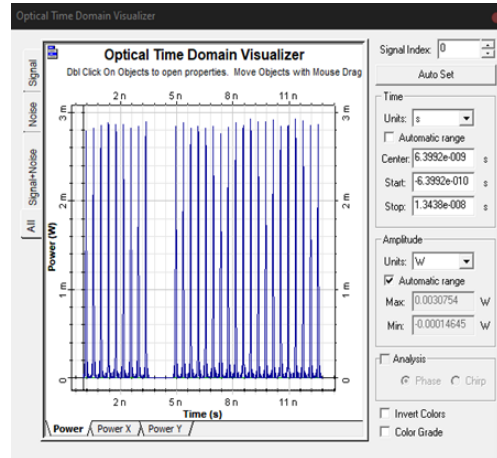
(3)



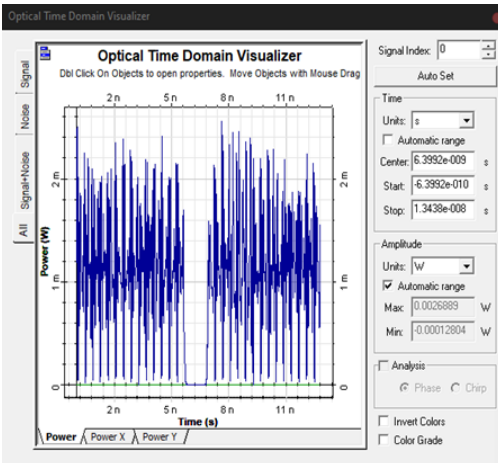
(4)



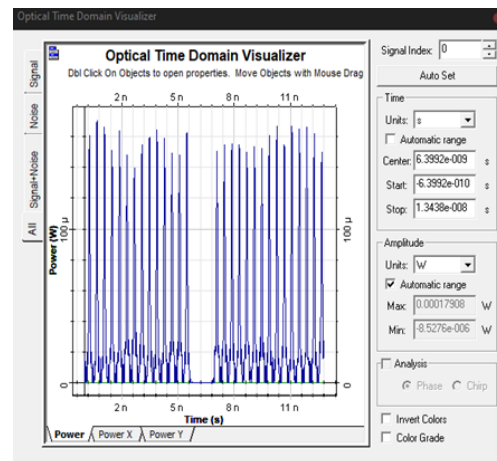
(5)



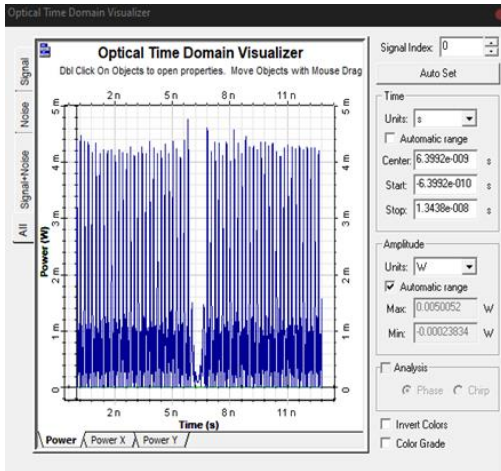
(6)



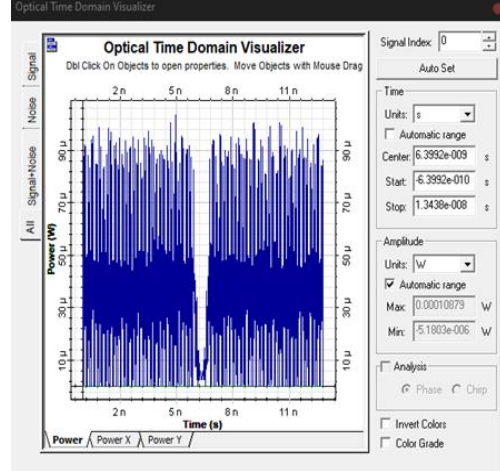
(7)



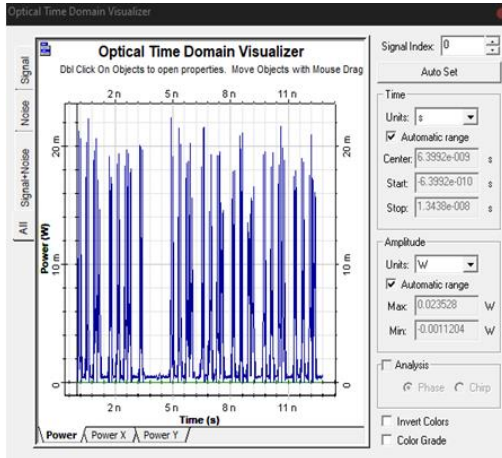
(8)



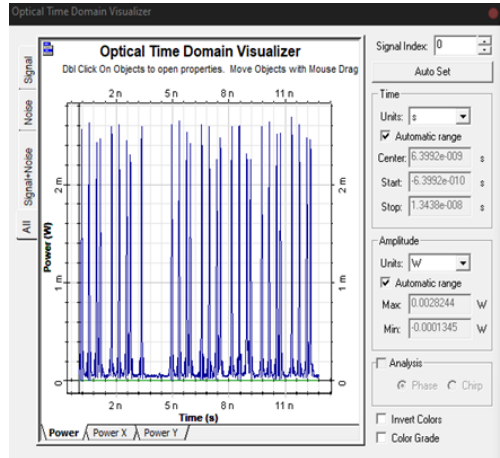
(9)



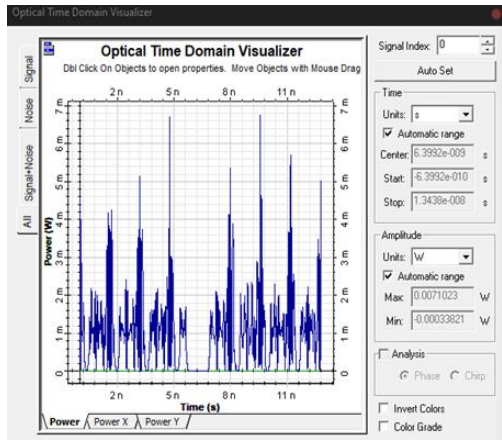
(10)



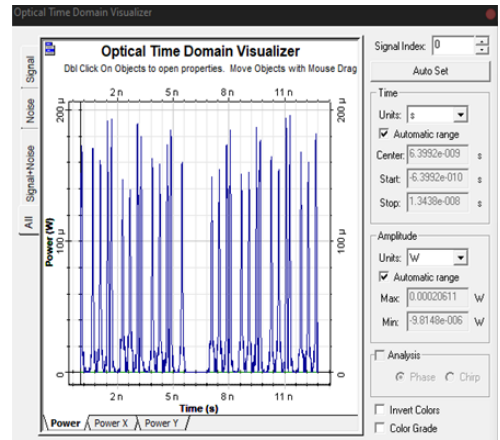
(11)



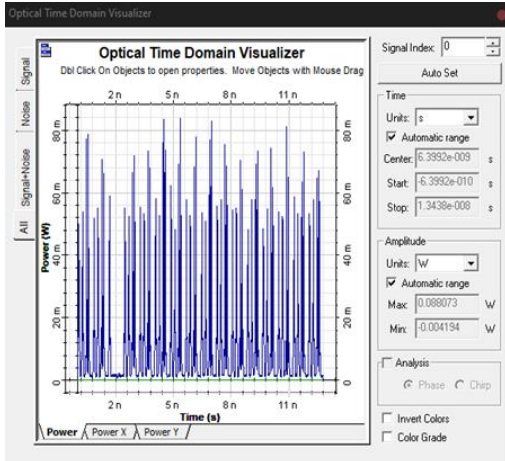
(12)



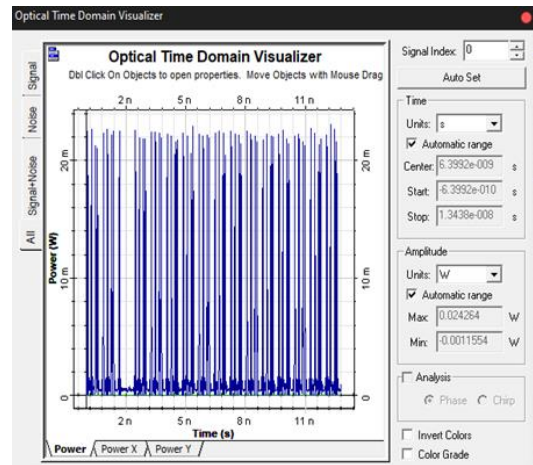
(13)



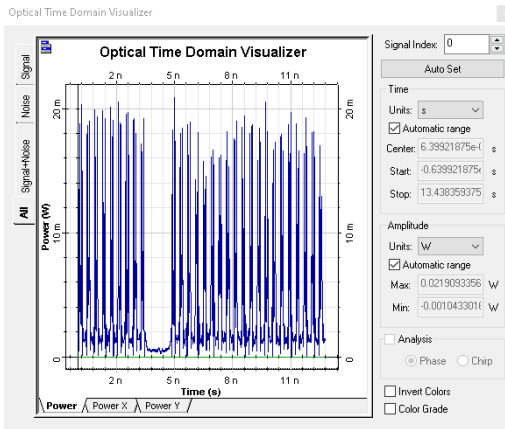
(14)



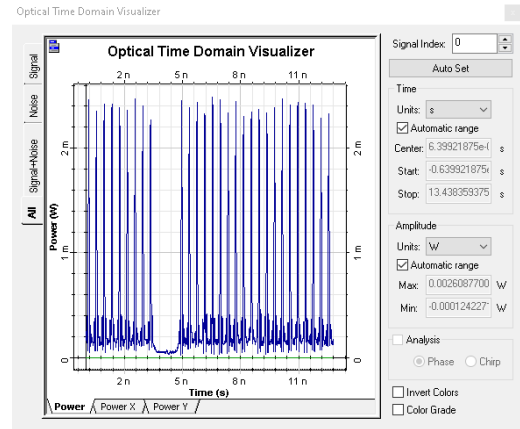
(15)



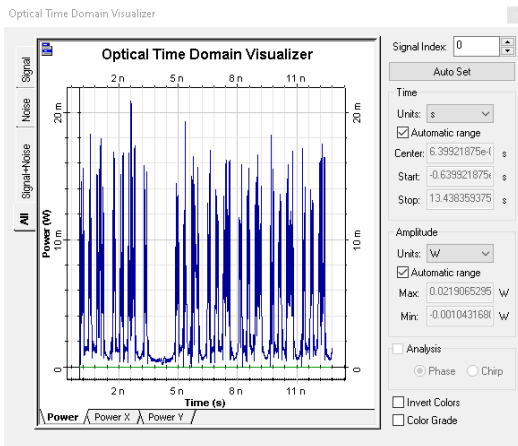
(16)



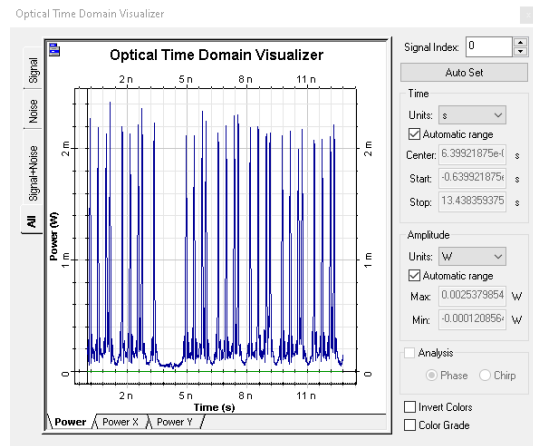
(17)



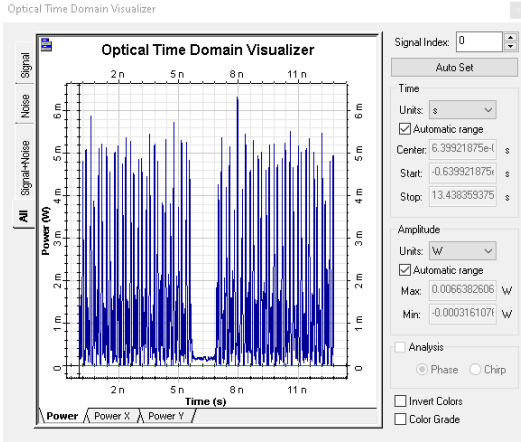
(18)



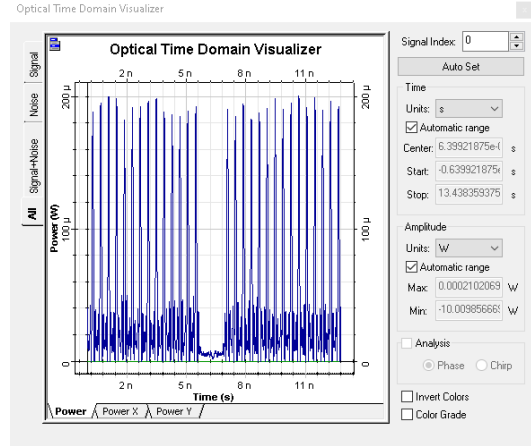
(19)



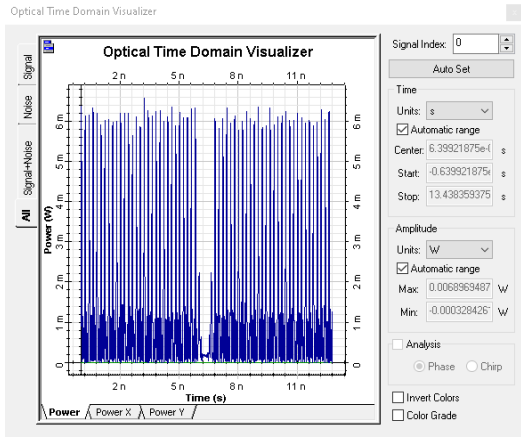
(20)



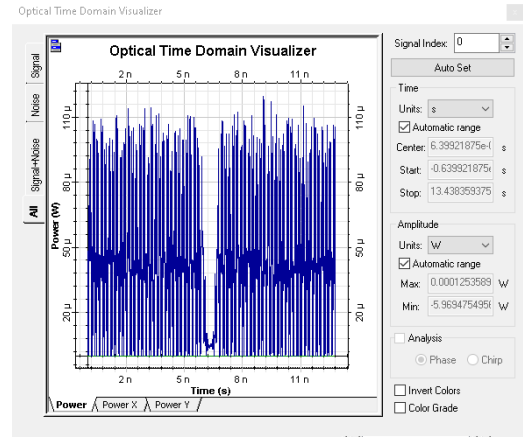
(21)



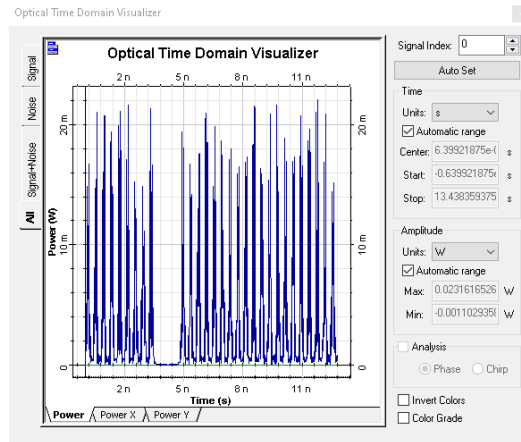
(22)



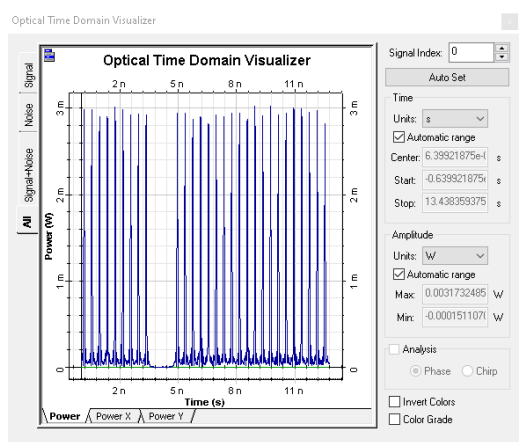
(23)



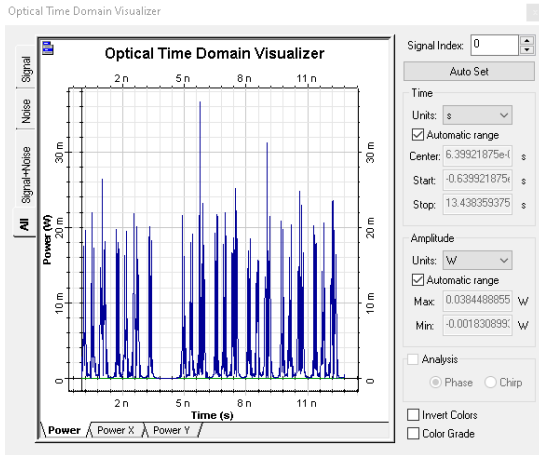
(24)



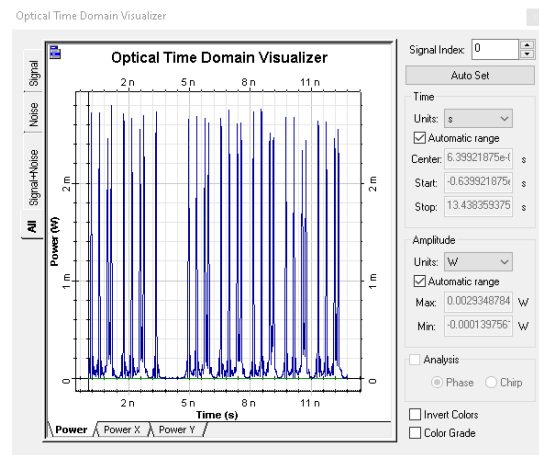
(25)



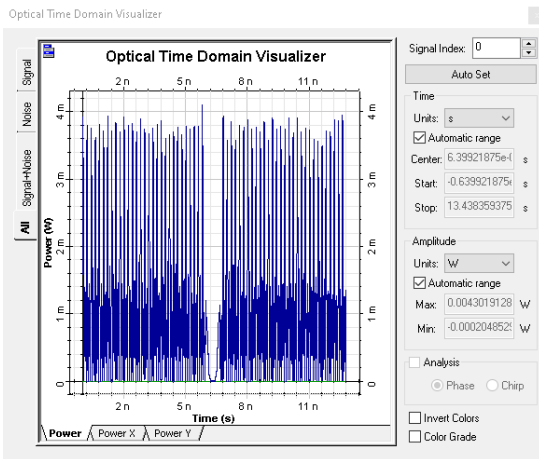
(26)



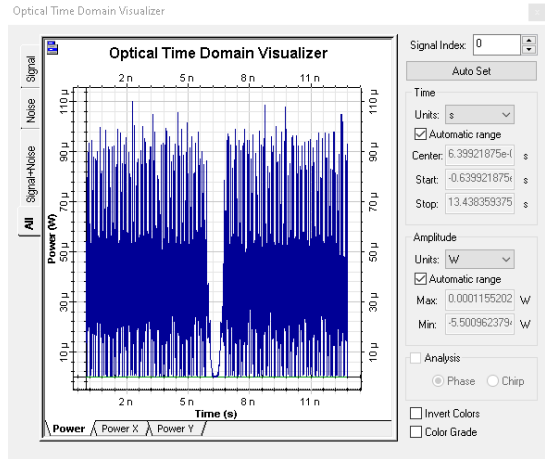
(27)



(28)



(29)



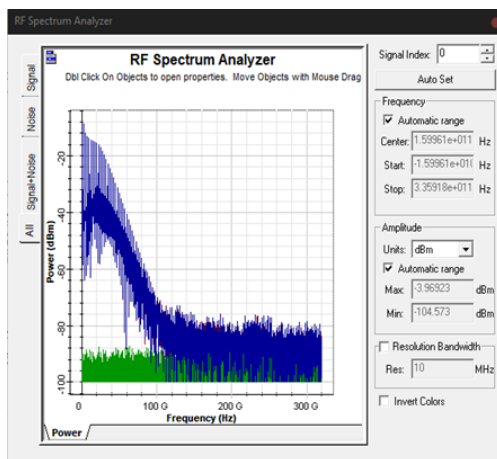
(30)

**Figure-3.4** Optical Time Domain Visualizer (1) 4 Bit, 5Gbps, Gaussian pulse, Electroabsorption modulator, 50km at attenuation 0.1 (2) 4 Bit, 5Gbps, Gaussian pulse, Electroabsorption modulator, 50 km at attenuation 0.2 (3) 4 Bit, 5Gbps, Gaussian pulse, Electroabsorption modulator, 100 km at attenuation 0.1 (4) 4 Bit, 5Gbps, Gaussian pulse, Electroabsorption modulator, 100 km at attenuation 0.2 (5) 4 Bit, 5Gbps, Gaussian pulse, Mach-Zehnder modulator, 100 km at attenuation 0.1 (6) 4 Bit, 5Gbps, Gaussian pulse, Mach-Zehnder modulator, 100 km at attenuation 0.2 (7) 4 Bit, 5Gbps, Gaussian pulse, Mach-Zehnder modulator, 150 km at attenuation 0.1 (8) 4 Bit, 5Gbps, Gaussian pulse, Mach-Zehnder modulator, 150 km at attenuation 0.2 (9) 4 Bit, 10Gbps, Gaussian pulse, Electroabsorption modulator, 150 km at attenuation 0.1 (10) 4 Bit, 10Gbps, Gaussian pulse, Electroabsorption modulator, 150 km at attenuation 0.2 (11) 8 Bit, 5Gbps, Gaussian pulse, Electroabsorption modulator, 100 km at attenuation 0.1 (12) 8 Bit, 5Gbps, Gaussian pulse, Electroabsorption modulator, 100 km at attenuation 0.2 (13) 8 Bit, 5Gbps, Gaussian pulse, Mach-Zehnder modulator, 150 km at attenuation 0.1 (14) 8 Bit, 5Gbps, Gaussian pulse, Mach-Zehnder modulator, 150 km at attenuation 0.2 (15) 8 Bit, 10Gbps, Gaussian pulse, Electroabsorption modulator, 50 km at attenuation 0.1 (16) 8 Bit, 10Gbps,

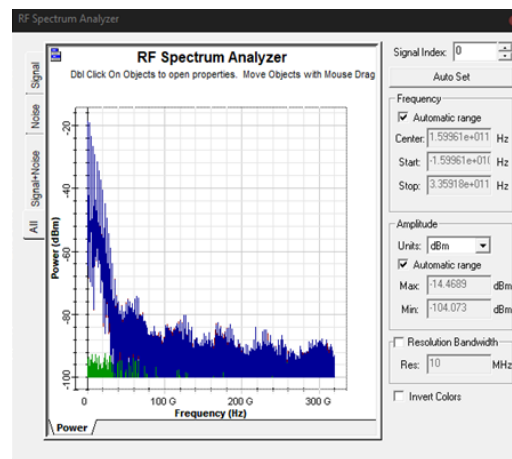
## Chapter-3 Design and Simulation

Gaussian pulse, Electroabsorption modulator, 50 km at attenuation 0.2 (17) 4 Bit, 5Gbps, Hyperbolic Secant pulse, Electroabsorption modulator, 100 km at attenuation 0.1 (18) 4 Bit, 5Gbps, Hyperbolic Secant pulse, Electroabsorption modulator, 100 km at attenuation 0.2 (19) 8 Bit, 5Gbps, Hyperbolic Secant pulse, Electroabsorption modulator, 100 km at attenuation 0.1 (20) 8 Bit, 5Gbps, Hyperbolic Secant pulse, Electroabsorption modulator, 100 km at attenuation 0.2 (21) 4 Bit, 5Gbps, Hyperbolic Secant pulse, Electroabsorption modulator, 150 km at attenuation 0.1 (22) 4 Bit, 5Gbps, Hyperbolic Secant pulse, Electroabsorption modulator, 150 km at attenuation 0.2 (23) 4 Bit, 10Gbps, Hyperbolic Secant pulse, Electroabsorption modulator, 150 km at attenuation 0.1 (24) 4 Bit, 10Gbps, Hyperbolic Secant pulse, Electroabsorption modulator, 150 km at attenuation 0.2 (25) 4 Bit, 5Gbps, Hyperbolic Secant pulse, Mach-Zehnder modulator, 100 km at attenuation 0.1 (26) 4 Bit, 5Gbps, Hyperbolic Secant pulse, Mach-Zehnder modulator, 100 km at attenuation 0.2 (27) 8 Bit, 5Gbps, Hyperbolic Secant pulse, Mach-Zehnder modulator, 100 km at attenuation 0.1 (28) 8 Bit, 5Gbps, Hyperbolic Secant pulse, Mach-Zehnder modulator, 100 km at attenuation 0.2 (29) 4 Bit, 10Gbps, Hyperbolic Secant pulse, Mach-Zehnder modulator, 150 km at attenuation 0.1 (30) 4 Bit, 10Gbps, Hyperbolic Secant pulse, Mach-Zehnder modulator, 150 km at attenuation 0.2

After visualizing the optical time domain visualizer we have found that for Hyperbolic Secant pulse generator with Mach-Zehnder modulator in 8 Bit, 50km at 5Gbps and at attenuation 0.1 the max power is the highest which is 0.22427W. Like as optical power meter when the length increases the max power decrease. So at the higher length we got the lowest max power. Next we will observe RF Spectrum Analyzer in figure-3.5.

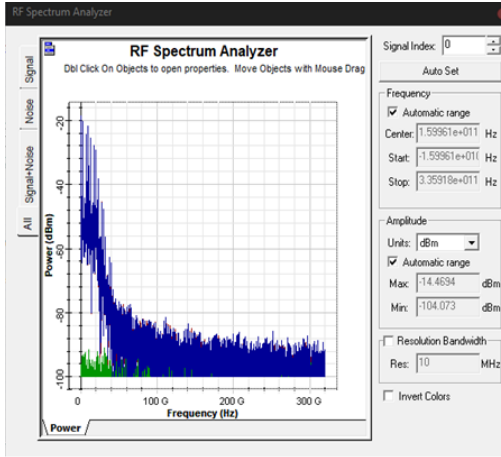


(1)

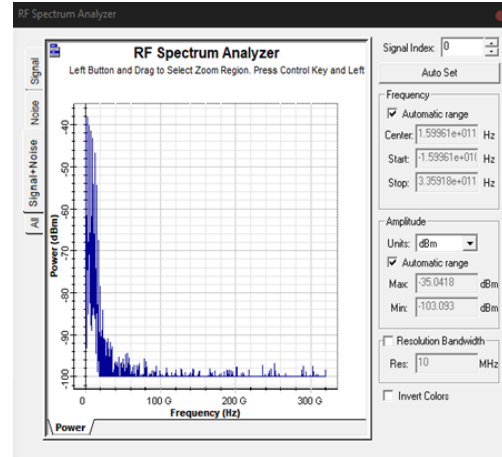


(2)

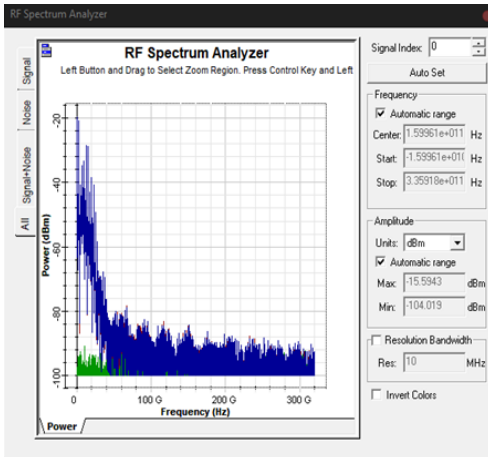




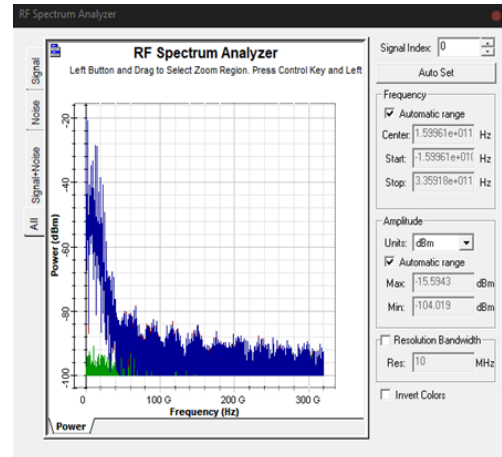
(3)



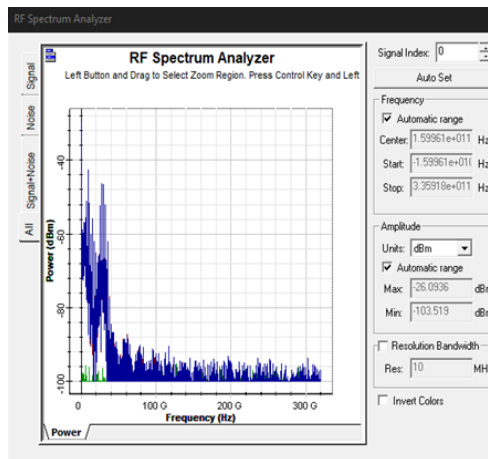
(4)



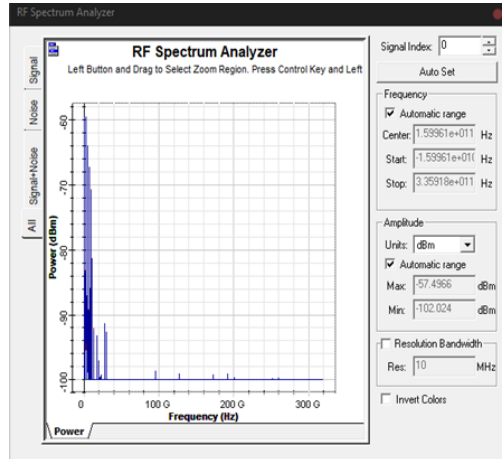
(5)



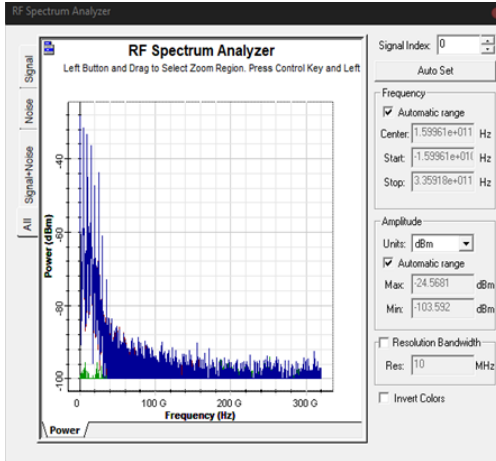
(6)



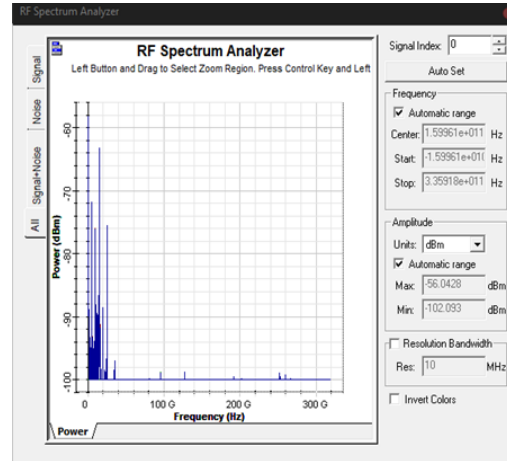
(7)



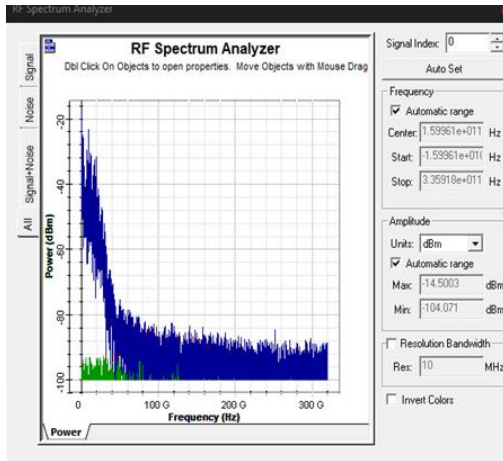
(8)



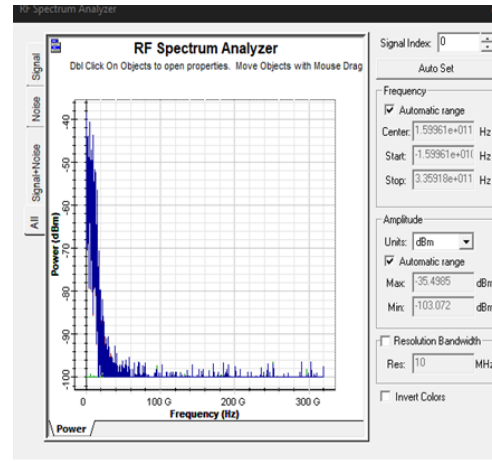
(9)



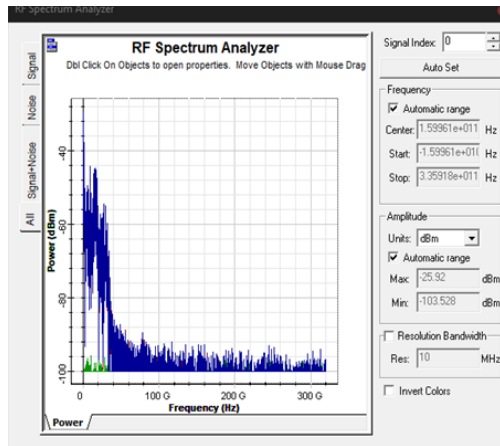
(10)



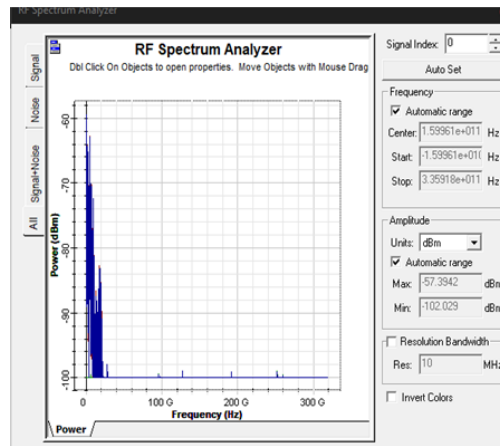
(11)



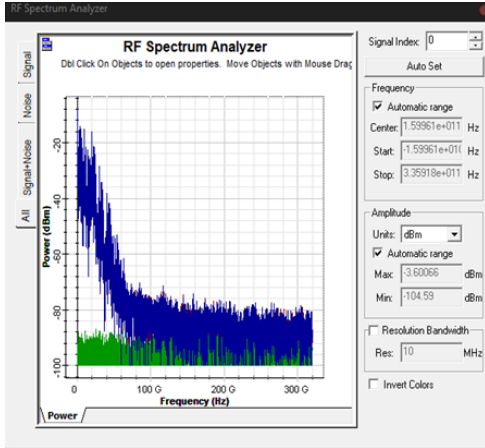
(12)



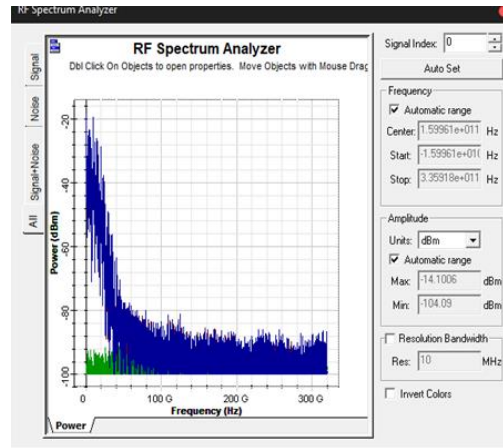
(13)



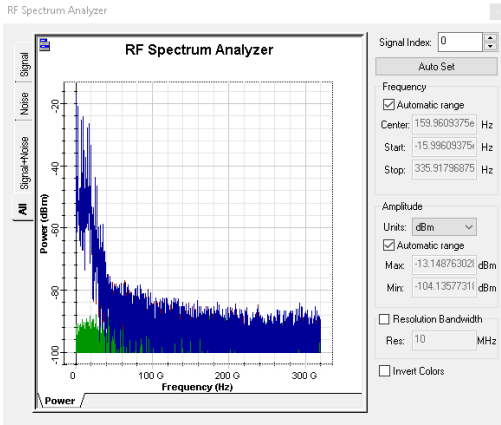
(14)



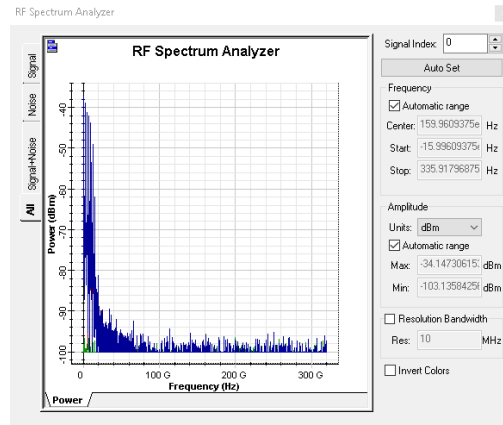
(15)



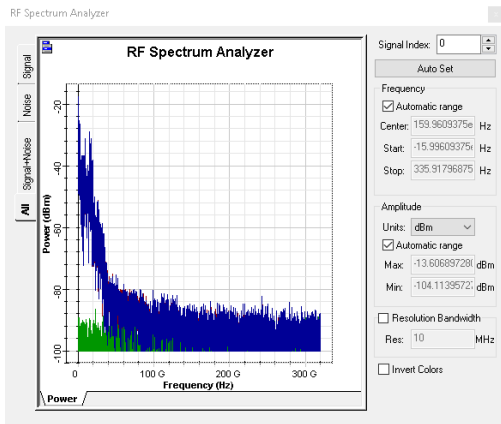
(16)



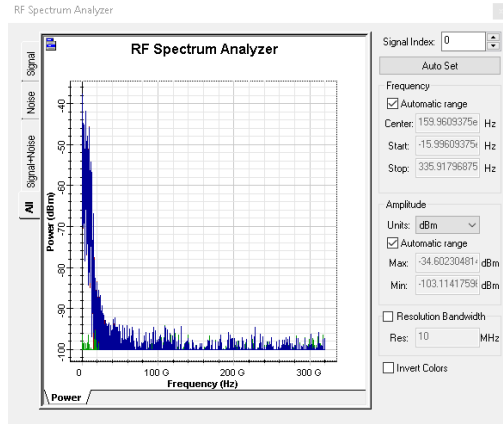
(17)



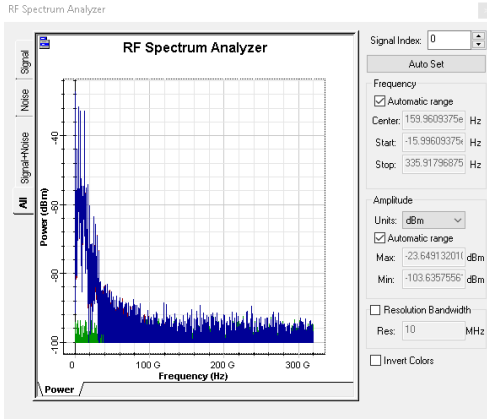
(18)



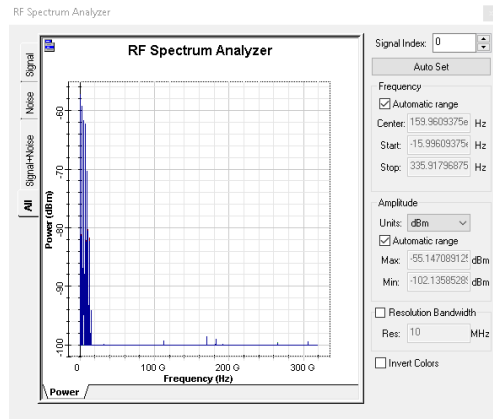
(19)



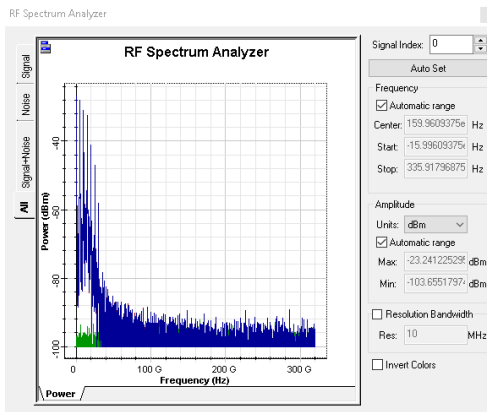
(20)



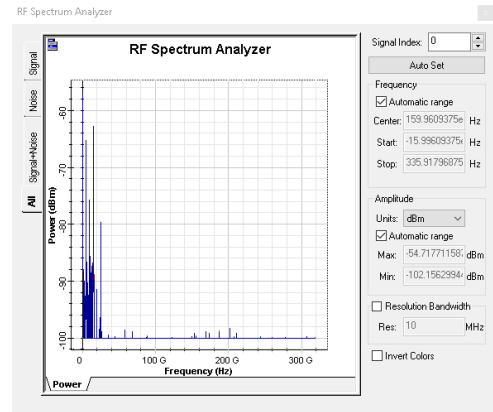
(21)



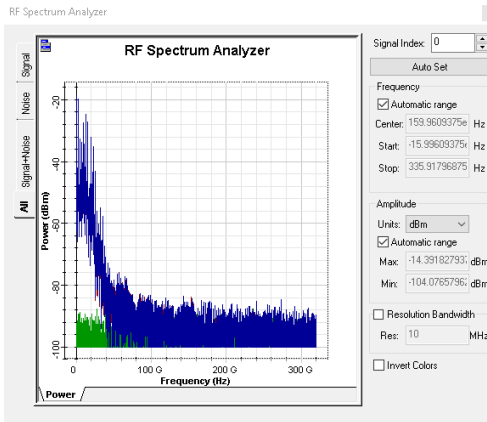
(22)



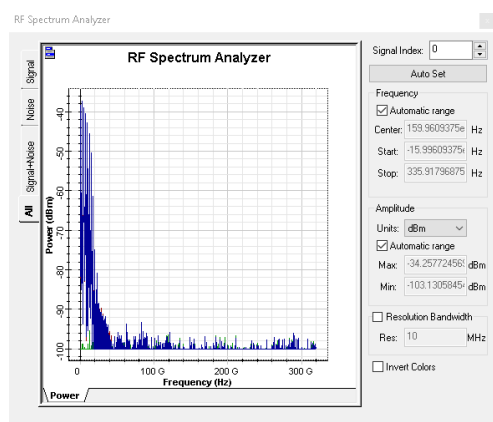
(23)



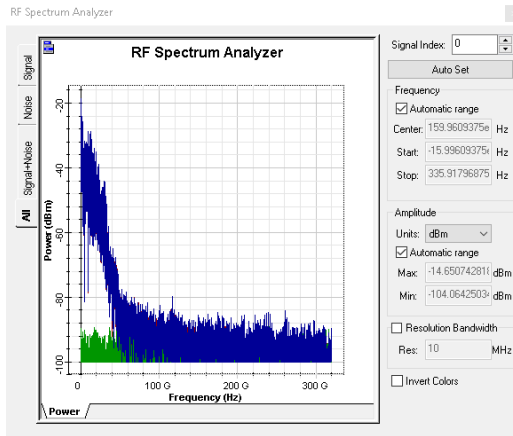
(24)



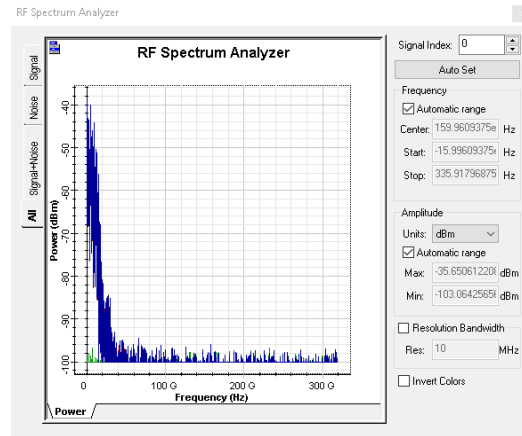
(25)



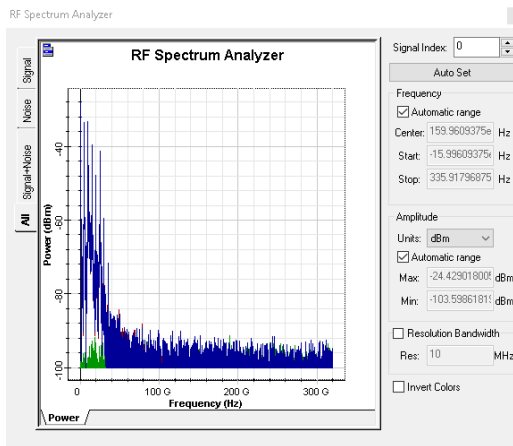
(26)



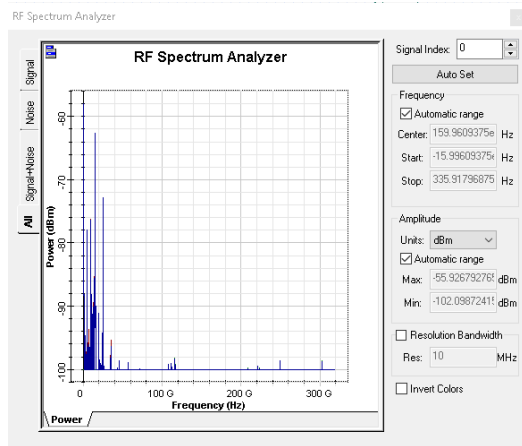
(27)



(28)



(29)

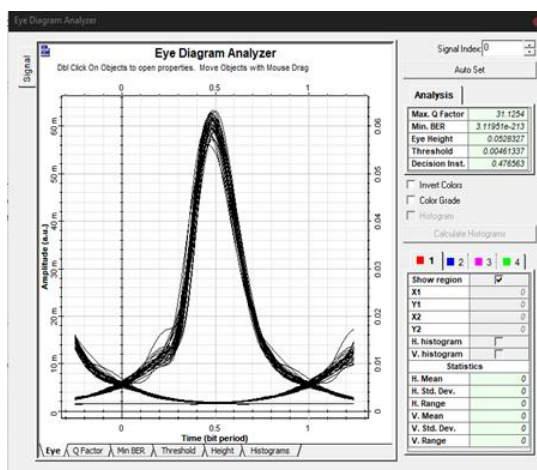


(30)

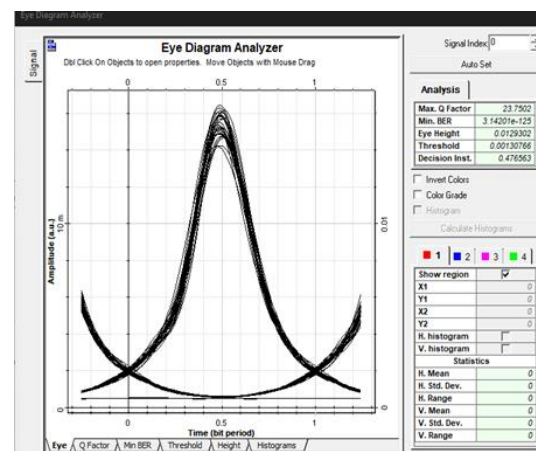
**Figure-3.5** RF Spectrum Analyzer (1) 4 Bit, 5Gbps, Gaussian pulse, Electroabsorption modulator, 50km at attenuation 0.1 (2) 4 Bit, 5Gbps, Gaussian pulse, Electroabsorption modulator, 50 km at attenuation 0.2 (3) 4 Bit, 5Gbps, Gaussian pulse, Electroabsorption modulator, 100 km at attenuation 0.1 (4) 4 Bit, 5Gbps, Gaussian pulse, Electroabsorption modulator, 100 km at attenuation 0.2 (5) 4 Bit, 5Gbps, Gaussian pulse, Mach-Zehnder modulator, 100 km at attenuation 0.1 (6) 4 Bit, 5Gbps, Gaussian pulse, Mach-Zehnder modulator, 100 km at attenuation 0.2 (7) 4 Bit, 5Gbps, Gaussian pulse, Mach-Zehnder modulator, 150 km at attenuation 0.1 (8) 4 Bit, 5Gbps, Gaussian pulse, Mach-Zehnder modulator, 150 km at attenuation 0.2 (9) 4 Bit, 10Gbps, Gaussian pulse, Electroabsorption modulator, 150 km at attenuation 0.1 (10) 4 Bit, 10Gbps, Gaussian pulse, Electroabsorption modulator, 150 km at attenuation 0.2 (11) 8 Bit, 5Gbps, Gaussian pulse, Electroabsorption modulator, 100 km at attenuation 0.1 (12) 8 Bit, 5Gbps, Gaussian pulse, Electroabsorption modulator, 100 km at attenuation 0.2 (13) 8 Bit, 5Gbps, Gaussian pulse, Mach-Zehnder modulator, 150 km at attenuation 0.1 (14) 8 Bit, 5Gbps, Gaussian pulse, Mach-Zehnder modulator, 150 km at attenuation 0.2 (15) 8 Bit, 10Gbps, Gaussian pulse, Electroabsorption modulator, 50 km at attenuation 0.1 (16) 8 Bit, 10Gbps, Gaussian pulse, Electroabsorption

modulator, 50 km at attenuation 0.2 (17) 4 Bit, 5Gbps, Hyperbolic Secant pulse, Electroabsorption modulator, 100 km at attenuation 0.1 (18) 4 Bit, 5Gbps, Hyperbolic Secant pulse, Electroabsorption modulator, 100 km at attenuation 0.2 (19) 8 Bit, 5Gbps, Hyperbolic Secant pulse, Electroabsorption modulator, 100 km at attenuation 0.1 (20) 8 Bit, 5Gbps, Hyperbolic Secant pulse, Electroabsorption modulator, 100 km at attenuation 0.2 (21) 4 Bit, 5Gbps, Hyperbolic Secant pulse, Electroabsorption modulator, 150 km at attenuation 0.1 (22) 4 Bit, 5Gbps, Hyperbolic Secant pulse, Electroabsorption modulator, 150 km at attenuation 0.2 (23) 4 Bit, 10Gbps, Hyperbolic Secant pulse, Electroabsorption modulator, 150 km at attenuation 0.1 (24) 4 Bit, 10Gbps, Hyperbolic Secant pulse, Electroabsorption modulator, 150 km at attenuation 0.2 (25) 4 Bit, 5Gbps, Hyperbolic Secant pulse, Mach-Zehnder modulator, 100 km at attenuation 0.1 (26) 4 Bit, 5Gbps, Hyperbolic Secant pulse, Mach-Zehnder modulator, 100 km at attenuation 0.2 (27) 8 Bit, 5Gbps, Hyperbolic Secant pulse, Mach-Zehnder modulator, 100 km at attenuation 0.1 (28) 8 Bit, 5Gbps, Hyperbolic Secant pulse, Mach-Zehnder modulator, 100 km at attenuation 0.2 (29) 4 Bit, 10Gbps, Hyperbolic Secant pulse, Mach-Zehnder modulator, 150 km at attenuation 0.1 (30) 4 Bit, 10Gbps, Hyperbolic Secant pulse, Mach-Zehnder modulator, 150 km at attenuation 0.2

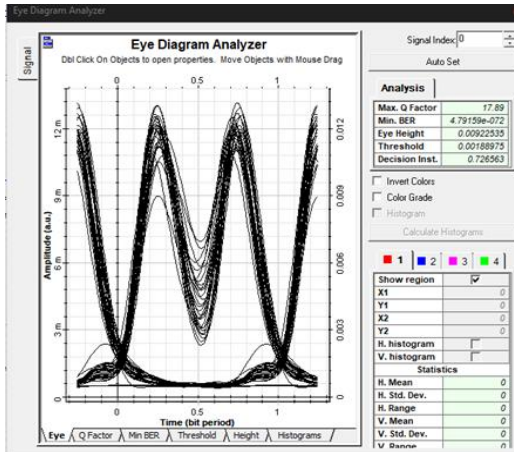
After observing the result we got the similar result with Optical power meter result. It means for Hyperbolic Secant pulse generator with Electroabsorption modulator in 4 Bit, 50km at 10Gbps and at attenuation 0.1 we got the highest max value which is -2.241033dBm. Also like above results max value decreases when the length increases. Now in figure-3.6 we will analyze the most important part BER analyzer.



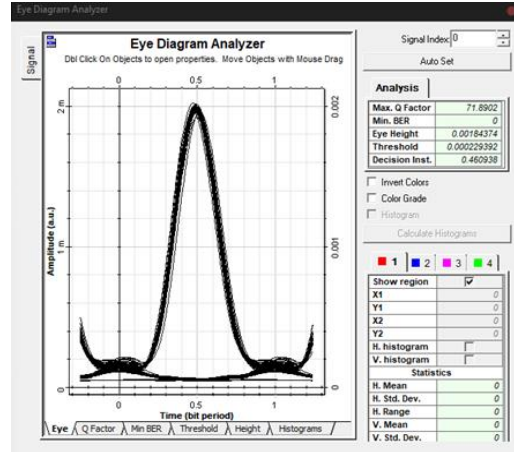
(1)



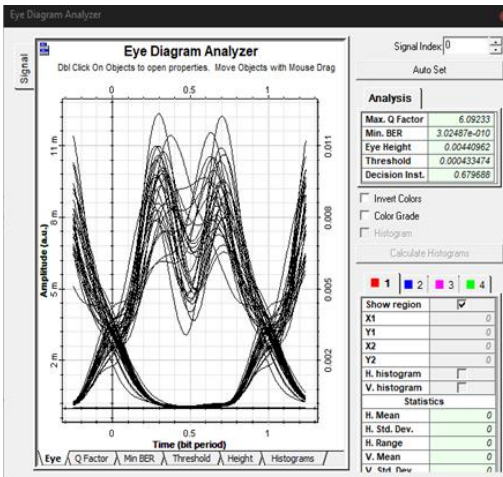
(2)



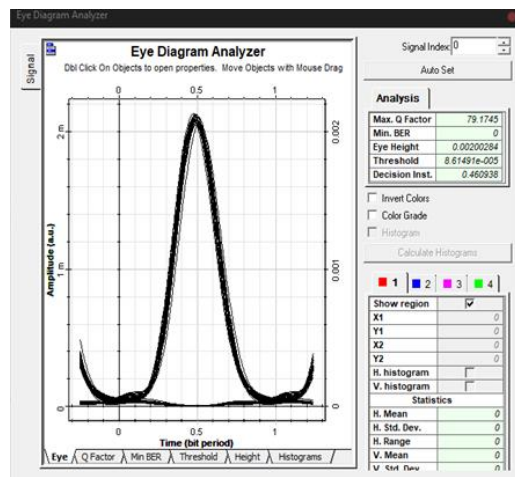
(3)



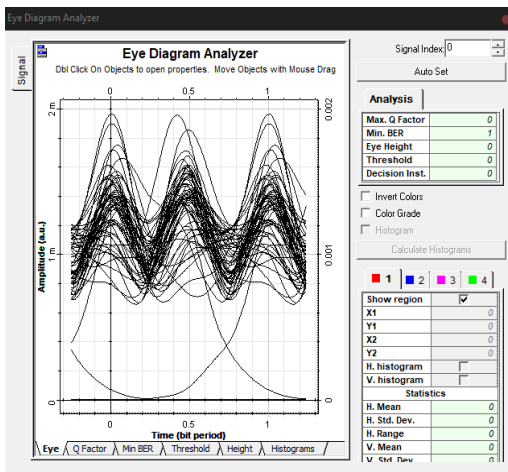
(4)



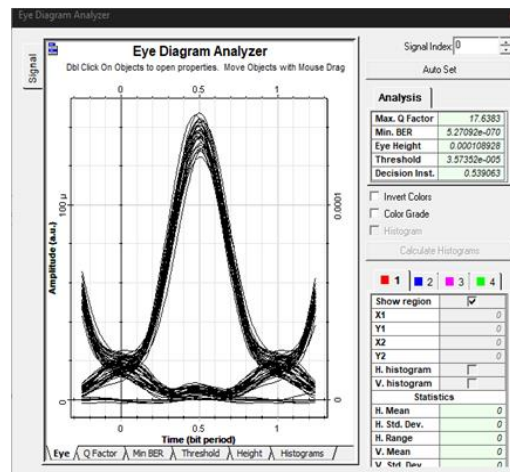
(5)



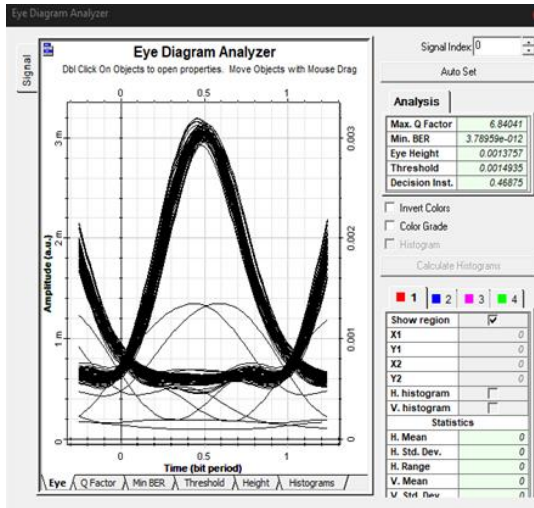
(6)



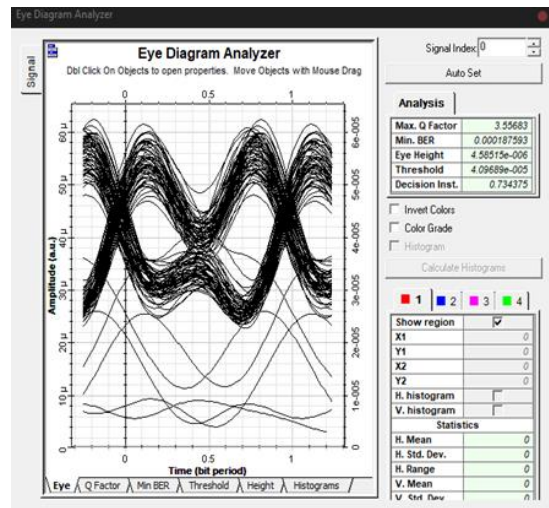
(7)



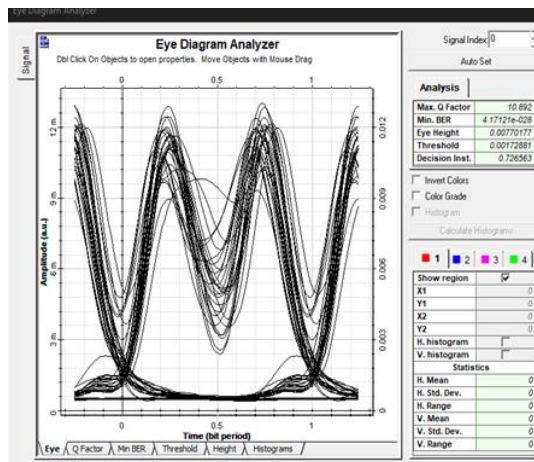
(8)



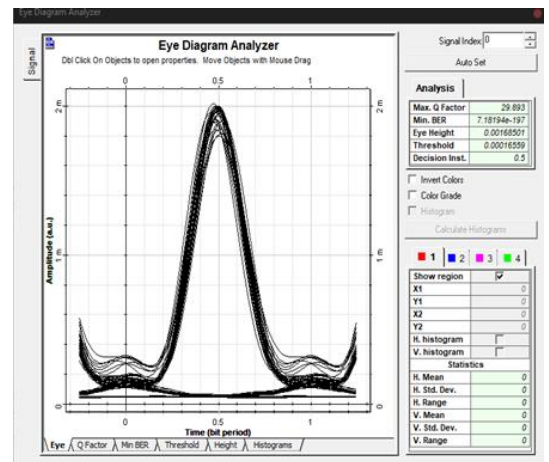
(9)



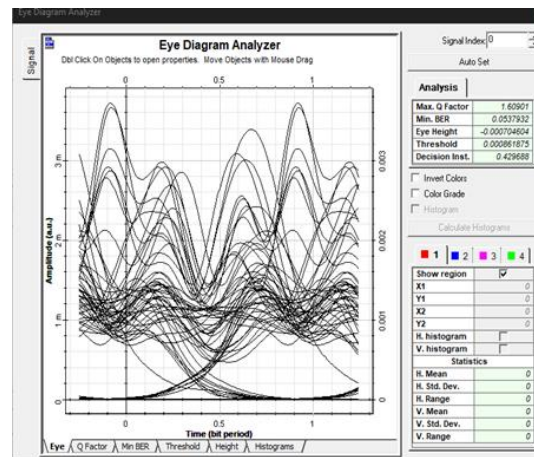
(10)



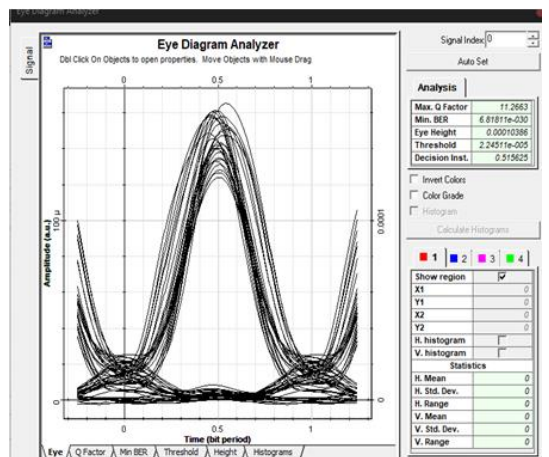
(11)



(12)

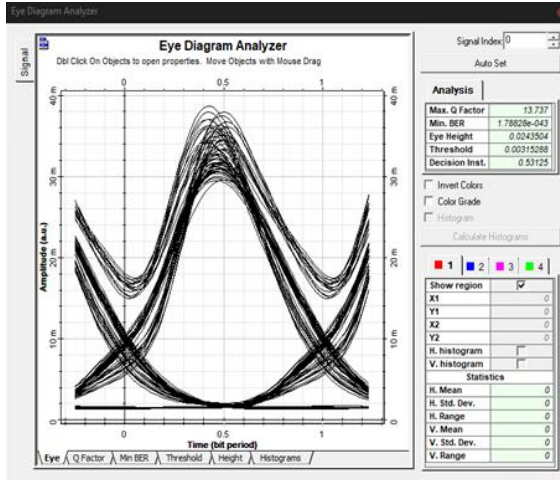


(13)

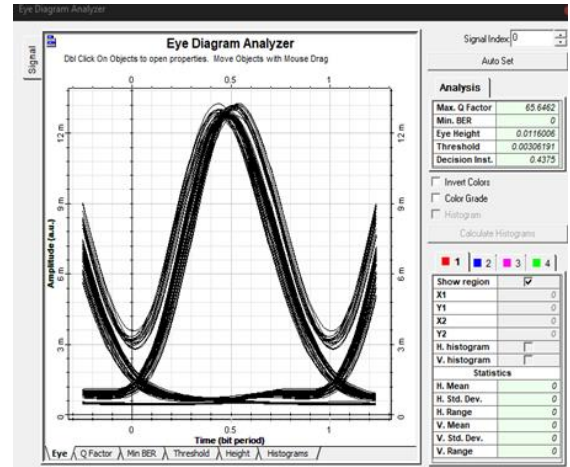


(14)

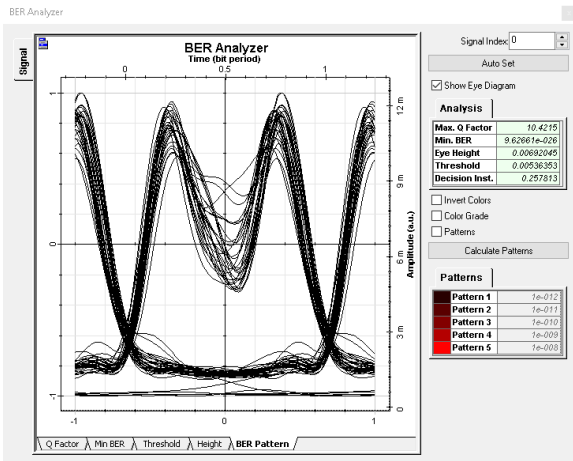




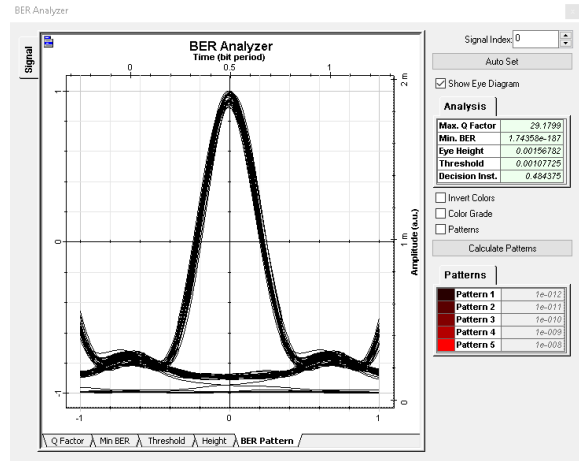
(15)



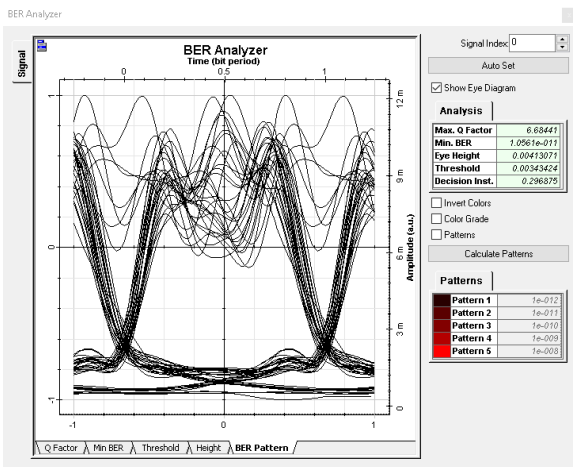
(16)



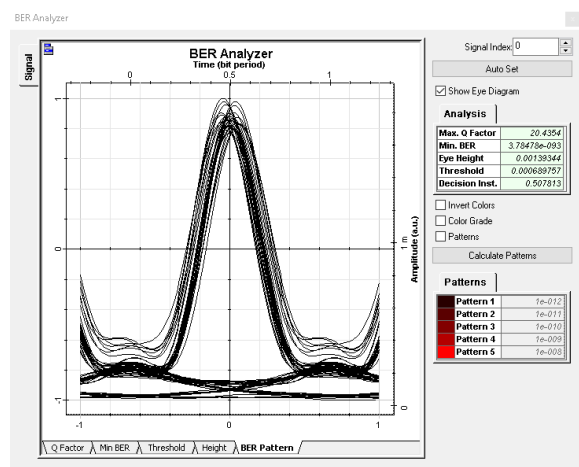
(17)



(18)

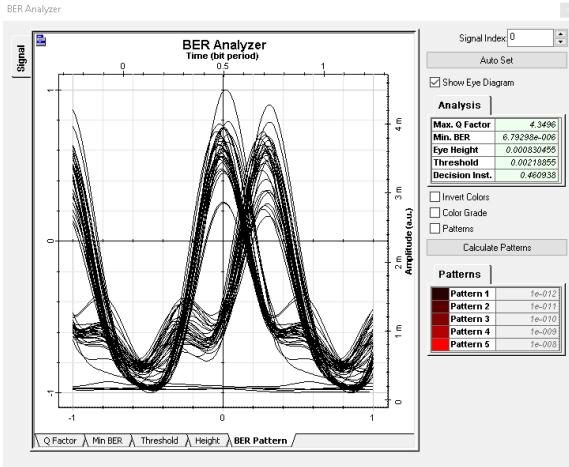


(19)

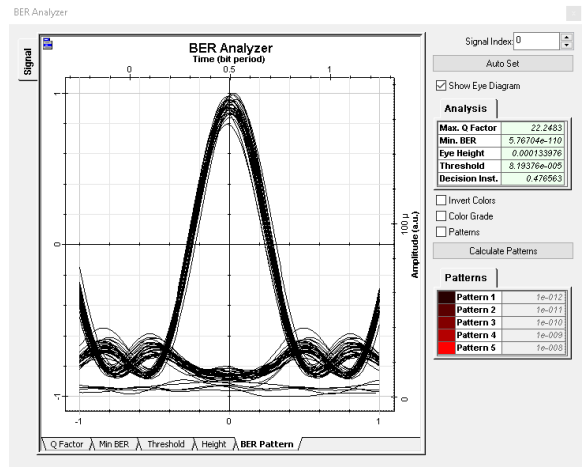


(20)

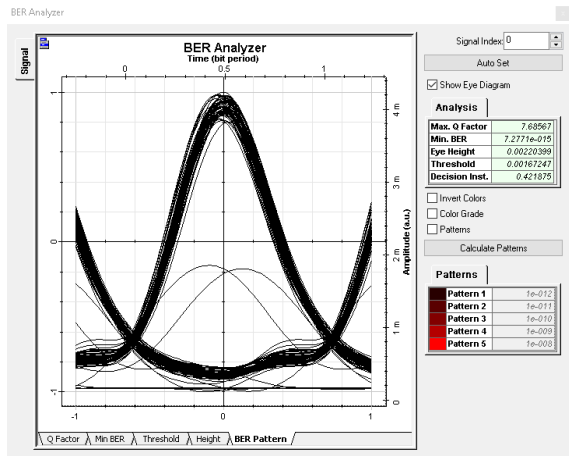
# Chapter-3 Design and Simulation



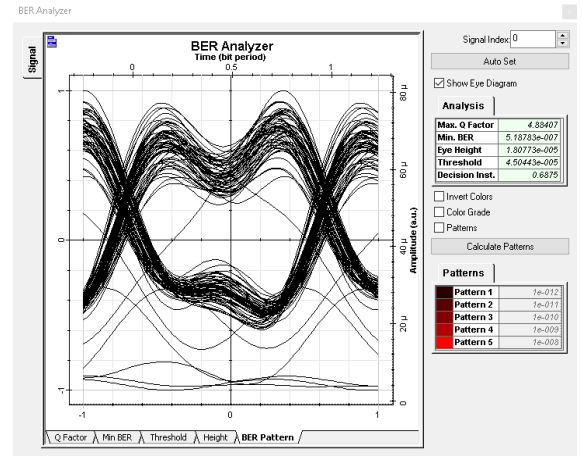
(21)



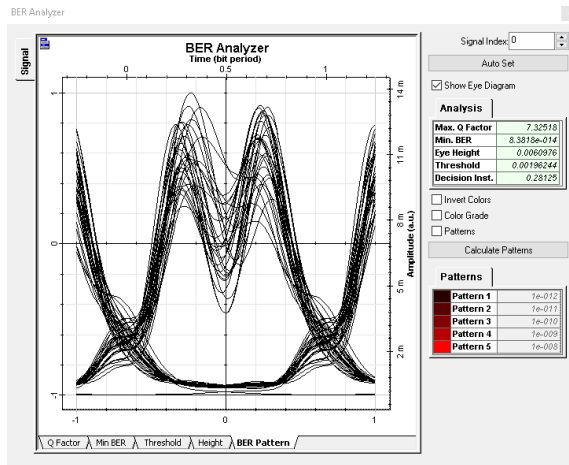
(22)



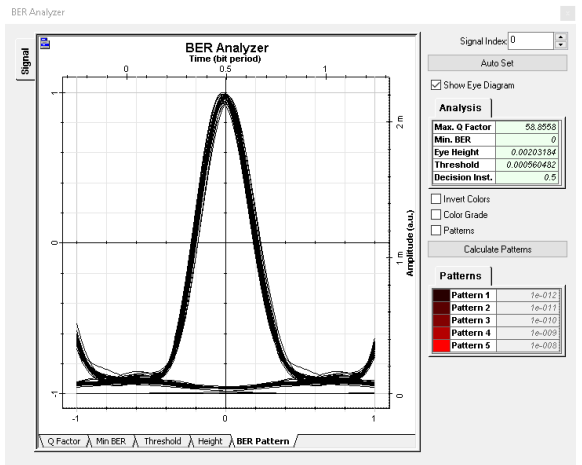
(23)



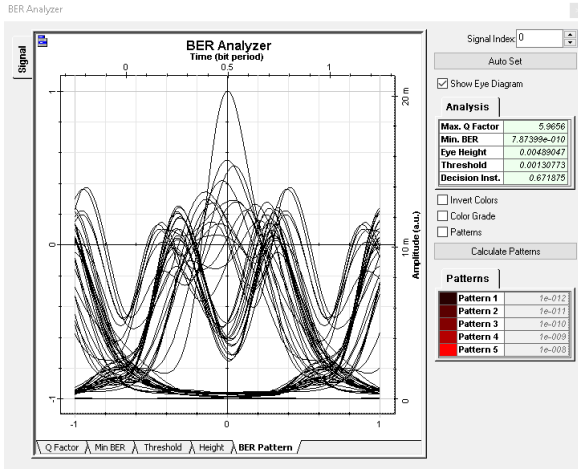
(24)



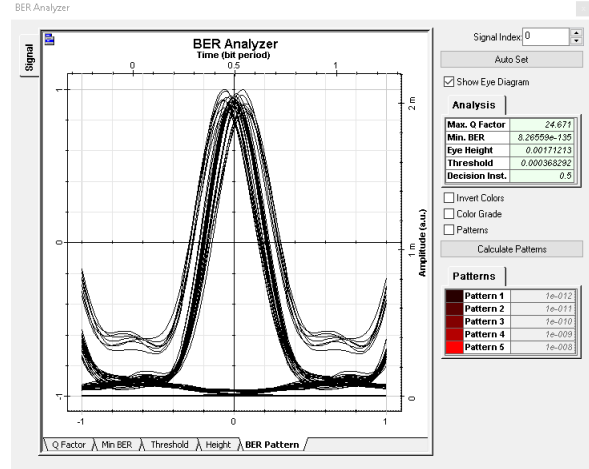
(25)



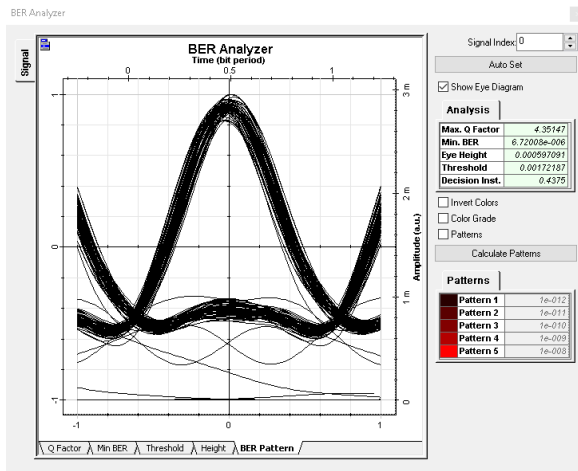
(26)



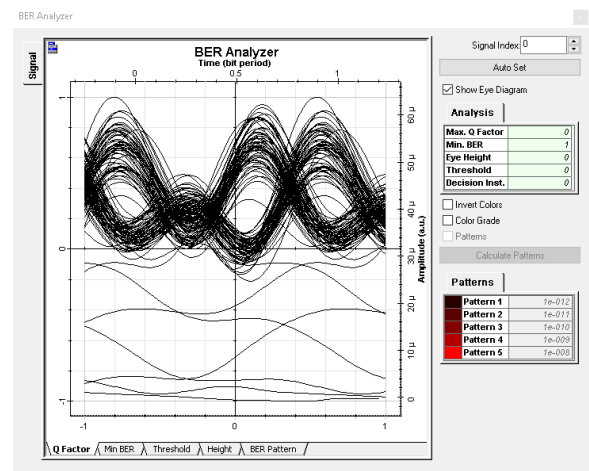
(27)



(28)



(29)



(30)

**Figure-3.6** BER Analyzer (1) 4 Bit, 5Gbps, Gaussian pulse, Electroabsorption modulator, 50km at attenuation 0.1 (2) 4 Bit, 5Gbps, Gaussian pulse, Electroabsorption modulator, 50 km at attenuation 0.2 (3) 4 Bit, 5Gbps, Gaussian pulse, Electroabsorption modulator, 100 km at attenuation 0.1 (4) 4 Bit, 5Gbps, Gaussian pulse, Electroabsorption modulator, 100 km at attenuation 0.2 (5) 4 Bit, 5Gbps, Gaussian pulse, Mach-Zehnder modulator, 100 km at attenuation 0.1 (6) 4 Bit, 5Gbps, Gaussian pulse, Mach-Zehnder modulator, 100 km at attenuation 0.2 (7) 4 Bit, 5Gbps, Gaussian pulse, Mach-Zehnder modulator, 150 km at attenuation 0.1 (8) 4 Bit, 5Gbps, Gaussian pulse, Mach-Zehnder modulator, 150 km at attenuation 0.2 (9) 4 Bit, 10Gbps, Gaussian pulse, Electroabsorption modulator, 150 km at attenuation 0.1 (10) 4 Bit, 10Gbps, Gaussian pulse, Electroabsorption modulator, 150 km at attenuation 0.2 (11) 8 Bit, 5Gbps, Gaussian pulse, Electroabsorption modulator, 100 km at attenuation 0.1 (12) 8 Bit, 5Gbps, Gaussian pulse, Electroabsorption modulator, 100 km at attenuation 0.2 (13) 8 Bit, 5Gbps, Gaussian pulse, Mach-Zehnder modulator, 150 km at attenuation 0.1 (14) 8 Bit, 5Gbps, Gaussian pulse, Mach-Zehnder modulator, 150 km at attenuation 0.2 (15) 8 Bit, 10Gbps, Gaussian pulse, Electroabsorption modulator, 50 km at attenuation 0.1 (16) 8 Bit, 10Gbps, Gaussian pulse, Electroabsorption

modulator, 50 km at attenuation 0.2 (17) 4 Bit, 5Gbps, Hyperbolic Secant pulse, Electroabsorption modulator, 100 km at attenuation 0.1 (18) 4 Bit, 5Gbps, Hyperbolic Secant pulse, Electroabsorption modulator, 100 km at attenuation 0.2 (19) 8 Bit, 5Gbps, Hyperbolic Secant pulse, Electroabsorption modulator, 100 km at attenuation 0.1 (20) 8 Bit, 5Gbps, Hyperbolic Secant pulse, Electroabsorption modulator, 100 km at attenuation 0.2 (21) 4 Bit, 5Gbps, Hyperbolic Secant pulse, Electroabsorption modulator, 150 km at attenuation 0.1 (22) 4 Bit, 5Gbps, Hyperbolic Secant pulse, Electroabsorption modulator, 150 km at attenuation 0.2 (23) 4 Bit, 10Gbps, Hyperbolic Secant pulse, Electroabsorption modulator, 150 km at attenuation 0.1 (24) 4 Bit, 10Gbps, Hyperbolic Secant pulse, Electroabsorption modulator, 150 km at attenuation 0.2 (25) 4 Bit, 5Gbps, Hyperbolic Secant pulse, Mach-Zehnder modulator, 100 km at attenuation 0.1 (26) 4 Bit, 5Gbps, Hyperbolic Secant pulse, Mach-Zehnder modulator, 100 km at attenuation 0.2 (27) 8 Bit, 5Gbps, Hyperbolic Secant pulse, Mach-Zehnder modulator, 100 km at attenuation 0.1 (28) 8 Bit, 5Gbps, Hyperbolic Secant pulse, Mach-Zehnder modulator, 100 km at attenuation 0.2 (29) 4 Bit, 10Gbps, Hyperbolic Secant pulse, Mach-Zehnder modulator, 150 km at attenuation 0.1 (30) 4 Bit, 10Gbps, Hyperbolic Secant pulse, Mach-Zehnder modulator, 150 km at attenuation 0.2

If we look at the result we got different result this time from the rest. For Gaussian pulse generator with Mach-Zehnder modulator in 4 Bit, 100km at 5Gbps and at attenuation 0.2 we got the highest Max Q. Factor which is 79.1745. This time we got better result at attenuation 0.2 where others got better result at attenuation 0.1

## Chapter-4

### Results and Analysis

#### 4.1 Result of all the possible simulation based on hyperbolic and Gaussain PG

System	Min BER	MaxQ	Optical power(dBm)	Eye height
1. 4bit-Hyperbolic-Electroabsorption- 50 km-5 Gbps (attenuation 0.1)	3.11951e-213	19.0661	11.350	0.04484
2. 4bit-Hyperbolic-Electroabsorption- 50 km-5 Gbps (attenuation 0.2)	3.14201e-125	17.0882	6.358	0.0111253
3. 8bit-Hyperbolic-Electroabsorption- 50 km-5 Gbps (attenuation 0.1)	4.79159e-072	16.7374	11.140	0.0411233
4. 8bit-Hyperbolic-Electroabsorption- 50 km-5 Gbps (attenuation 0.2)	0	14.6513	6.140	0.0100393
5. 4bit-Hyperbolic-Electroabsorption- 50 km-10 Gbps (attenuation 0.1)	0.0119047	15.4329	11.552	0.0255721
6. 4bit-Hyperbolic-Electroabsorption- 50 km-10 Gbps-(attenuation 0.2)	5.71725e-123	30.6139	6.551	0.0108298
7. 8bit-Hyperbolic-Electroabsorption- 50 km-10 Gbps-(attenuation 0.1)	7.19909e-148	11.4328	11.332	0.0257114
8. 8bit-Hyperbolic-Electroabsorption- 50 km-10 Gbps-(attenuation 0.2)	6.29717e-167	20.6099	6.332	0.009952
9. 4bit-Hyperbolic-Electroabsorption- 100 km-5 Gbps-(attenuation 0.1)	3.02487e-010	10.4215	6.350	0.00692045
10. 4bit-Hyperbolic-Electroabsorption- 100 km-5 Gbps-(attenuation 0.2)	0	29.1799	-3.643	0.001567
11. 8bit-Hyperbolic-Electroabsorption- 100 km-5 Gbps-(attenuation 0.1)	1	6.68441	6.140	0.004130
12. 8bit-Hyperbolic-Electroabsorption- 100 km-5 Gbps-(attenuation 0.2)	5.27092e-070	20.4354	-3.860	0.0013934
13. 4bit-Hyperbolic-Electroabsorption- 100 km-10 Gbps-(attenuation 0.1)	5.41059e-170	7.44997	6.551	0.00299366
14. 4bit-Hyperbolic-Electroabsorption- 100 km-10 Gbps-(attenuation 0.2)	0	5.18097	-3.447	0.00024422
15. 8bit-Hyperbolic-Electroabsorption- 100 km-10 Gbps-(attenuation 0.1)	1.12942e-025	0	6.332	0
16. 8bit-Hyperbolic-	1.02043e-006	4.65379	-3.668	0.000218821

**Chapter-4 Results and analysis**

Electroabsorption- 100 km-10 Gbps-(attenuation 0.2)				
17. 4bit-Hyperbolic-Electroabsorption- 150 km-5 Gbps- (attenuation 0.1)	3.78959e-012	4.3496	1.350	0.00083045
18. 4bit-Hyperbolic-Electroabsorption- 150 km-5 Gbps-(attenuation 0.2)	0.000187593	22.2483	-13.641	0.00013397
19. 8bit-Hyperbolic-Electroabsorption- 150 km-5 Gbps-(attenuation 0.1)	3.38848e-177	5.32454	1.139	0.00126306
20. 8bit-Hyperbolic-Electroabsorption- 150 km-5 Gbps-(attenuation 0.2)	0	20.3795	-13.860	0.0001244
21. 4bit-Hyperbolic-Electroabsorption- 150 km-10 Gbps-(attenuation 0.1)	1.9422e-010	7.68567	1.552	0.00220399
22. 4bit-Hyperbolic-Electroabsorption- 150 km-10 Gbps-(attenuation 0.2)	0.0321848	4.88407	-13.448	1.8077e^-005
23. 8bit-Hyperbolic-Electroabsorption- 150 km-10 Gbps-(attenuation 0.1)	1	1.52504	1.332	-0.00122097
24. 8bit-Hyperbolic-Electroabsorption- 150 km-10 Gbps-(attenuation 0.2)	1	2.18149	-13.668	-1.3360e^-005
25. 4bit-Hyperbolic-MechZehnder-50 km-5 Gbps-(attenuation 0.1)	5.36688e-163	16.5943	10.766	0.0426907
26. 4bit-Hyperbolic-MechZehnder-50 km-5 Gbps-(attenuation 0.2)	2.62629e-136	19.5938	5.765	0.0127725
27. 8bit-Hyperbolic-MechZehnder-50 km-5 Gbps-(attenuation 0.1)	4.1712e-028	15.9894	10.641	0.0354525
28. 8bit-Hyperbolic-MechZehnder-50 km-5 Gbps-(attenuation 0.2)	7.18194e-197	18.031	5.642	0.0114779
29. 4bit-Hyperbolic-MechZehnder-50 km-10 Gbps(attenuation 0.1)	0.00745901	21.1452	10.986	0.0232863
30. 4bit-Hyperbolic-MechZehnder-50 km-10 Gbps (attenuation 0.2)	7.75052e-091	42.7715	5.986	0.0118043
31. 8bit-Hyperbolic-MechZehnder-50 km-10 Gbps (attenuation 0.1)	5.81782e-129	6.68884	10.865	0.0178217
32. 8bit-Hyperbolic-MechZehnder-50 km-10 Gbps (attenuation 0.2)	5.43562e-190	19.6685	5.865	0.0106483
33. 4bit-Hyperbolic-MechZehnder-100 km-5 Gbps (attenuation 0.1)	2.39956e-011	7.32518	5.765	0.0060976
34. 4bit-Hyperbolic-MechZehnder-100 km-5 Gbps-(attenuation 0.2)	0	58.8558	-4.234	0.00203184
35. 8bit-Hyperbolic-MechZehnder-100 km-5 Gbps (attenuation 0.1)	0.0537932	5.9656	5.642	0.00489047
36. 8bit-Hyperbolic-MechZehnder-100 km-5 Gbps (attenuation 0.2)	6.81811e-030	24.671	-4.358	0.00171213
37. 4bit-Hyperbolic-MechZehnder-100 km-10 Gbps (attenuation 0.1)	1.78828e-043	6.82268	5.986	0.00278665
38. 4bit-Hyperbolic-MechZehnder-100 km-10 Gbps (attenuation 0.2)	0	2.29953	-4.014	-8.0148e^-005
39. 8bit-Hyperbolic-MechZehnder-100 km-10 Gbps(attenuation 0.1)	1	0	5.865	0

### Chapter-4 Results and analysis

40. 8bit-Hyperbolic-MechZehnder-100 km-10 Gbps(attenuation 0.2)	2.22976e-006	2.78329	-4.134	-3.377e^-005
41. 4bit-Hyperbolic-MechZehnder-150 km-5 Gbps(attenuation 0.1)	0.0627413	0	0.766	0
42. 4bit-Hyperbolic-MechZehnder-150 km-5 Gbps-(attenuation 0.2)	1	20.2724	-14.234	0.000137829
43. 8bit-Hyperbolic-MechZehnder-150 km-5 Gbps(attenuation 0.1)	3.50787e-021	1.74495	0.642	-0.00121503
44. 8bit-Hyperbolic-MechZehnder-150 km-5 Gbps(attenuation 0.2)	2.89427e-061	17.1648	-14.358	0.000126404
45. 4bit-Hyperbolic-MechZehnder-150 km-10 Gbps-(attenuation 0.1)	1	4.35147	0.986	0.000597091
46. 4bit-Hyperbolic-MechZehnder-150 km -10 Gbps-(attenuation 0.2)	0.0129363	0	-14.013	0
47. 8bit-Hyperbolic-MechZehnder-150 km-10 Gbps(attenuation 0.1)	1	0	0.865	0
48. 8bit-Hyperbolic-MechZehnder-150 km-10 Gbps(attenuation 0.2)	1	0	-14.135	0

**Table-4.1** This is the data table of Hyperbolic pulse generator based on 4 and 8-bit sequence on various modulators, fiber length, speed & attenuation.

System	MIN BER	Max Q factor	Max Optical power (dBm)	Eye height
1. 4 Bit-5 Gbps-Gaussian-Electro absorption- 50 km at attenuation 0.1	3.11951e-213	31.1254	10.720	0.0528327
2. 4 Bit-5 Gbps-Gaussian-Electro absorption- 50 km at attenuation 0.2	3.14201e-125	23.7502	5.729	0.0129302
3. 4 Bit-5 Gbps-Gaussian-Electro absorption- 100 km at attenuation 0.1	4.79159e-072	17.89	5.729	0.00922535
4. 4 Bit-5 Gbps-Gaussian-Electro absorption- 100 km at attenuation 0.2	0	71.8902	4.271	0.00184374
5. 4 Bit-5 Gbps-Gaussian-Electro absorption- 150 km at attenuation 0.1	0.0119047	2.28837	0.729	- 0.000493462
6. 4 Bit-5 Gbps-Gaussian-Electro absorption- 150 km at attenuation 0.2	5.71725e-123	23.5448	14.271	0.000134459
7. 4 Bit-5 Gbps-Gaussian-Mach Zehnder - 50 km at attenuation 0.1	7.19909e-148	25.8442	10.193	0.0500328
8. 4 Bit-5 Gbps-Gaussian-Mach Zehnder - 50 km at attenuation 0.2	6.29717e-167	27.4884	5.193	0.0141241
9. 4 Bit-5 Gbps-Gaussian-Mach Zehnder - 100 km at attenuation 0.1	3.02487e-010	6.09233	5.193	0.00440962
10. 4 Bit-5 Gbps-Gaussian-Mach Zehnder - 100 km at attenuation 0.2	0	79.1745	-4.807	0.00200284
11. 4 Bit-5 Gbps-Gaussian-Mach Zehnder - 150 km at attenuation 0.1	1	0	0.193	0
12. 4 Bit-5 Gbps-Gaussian-Mach Zehnder - 150 km at attenuation 0.2	5.2709e-070	17.6383	-14.006	0.00108928
13. 4 Bit-10 Gbps-Gaussian-Electro absorption- 50 km at attenuation 0.1	5.41059e-170	27.7576	10.919	0.0259122
14. 4 Bit-10 Gbps-Gaussian-Electro absorption- 50 km at attenuation 0.2	0	75.2048	5.919	0.0116545

**Chapter-4 Results and analysis**

15. 4 Bit-10 Gbps-Gaussian-Electro absorption- 100 km at attenuation 0.1	1.12942e-025	10.4087	5.919	0.0031709
16. 4 Bit-10 Gbps-Gaussian-Electro absorption- 100 km at attenuation 0.2	1.02043e-006	4.73416	-4.001	0.000133575
17. 4 Bit-10 Gbps-Gaussian-Electro absorption- 150 km at attenuation 0.1	3.78959e-012	6.84041	0.919	0.0013757
18. 4 Bit-10 Gbps-Gaussian-Electro absorption- 150 km at attenuation 0.2	0.000187593	3.55683	-14.001	4.58515e-006
19. 4 Bit-10 Gbps-Gaussian-March Zehnder - 50 km at attenuation 0.1	3.38848e-177	28.3486	10.412	0.0214468
20. 4 Bit-10 Gbps-Gaussian- March Zehnder -50 km at attenuation 0.2	0	45.6644	5.411	0.0103717
21. 4 Bit-10 Gbps-Gaussian- March Zehnder - 100 km at attenuation 0.1	1.9422e-010	6.25821	5.411	0.00210781
22. 4 Bit-10 Gbps-Gaussian- March Zehnder - 100 km at attenuation 0.2	0.0321848	1.77007	-4.500	- 0.000108362
23. 4 Bit-10 Gbps-Gaussian- March Zehnder - 150 km at attenuation 0.1	1	0	0.412	0
24. 4 Bit-10 Gbps-Gaussian- March Zehnder - 150 km at attenuation 0.2	1	0	-14.500	0
25. 8 Bit-5 Gbps-Gaussian-Electro absorption- 50 km at attenuation 0.1	5.36688e-163	27.1597	10.714	0.0509522
26. 8 Bit-5 Gbps-Gaussian-Electro absorption- 50 km at attenuation 0.2	2.62629e-136	24.8019	5.714	0.0126298
27. 8 Bit-5 Gbps-Gaussian-Electro absorption- 100 km at attenuation 0.1	4.17121e-028	10.892	5.714	0.00770177
28. 8 Bit-5 Gbps-Gaussian-Electro absorption- 100 km at attenuation 0.2	7.18194e-197	29.893	-4.206	0.00168501
29. 8 Bit-5 Gbps-Gaussian-Electro absorption- 150 km at attenuation 0.1	0.00745901	2.43378	0.713	-0.00050384
30. 8 Bit-5 Gbps-Gaussian-Electro absorption- 150 km at attenuation 0.2	7.75052e-091	20.163	-14.206	0.00128507
31. 8 Bit-5 Gbps-Gaussian-March Zehnder - 50 km at attenuation 0.1	5.81782e-129	24.104	10.276	0.0466296
32. 8 Bit-5 Gbps-Gaussian- March Zehnder -50 km at attenuation 0.2	5.43562e-190	29.3564	5.276	0.0132194
33. 8 Bit-5 Gbps-Gaussian- March Zehnder - 100 km at attenuation 0.1	2.39956e-011	6.48896	5.276	0.00478943
34. 8 Bit-5 Gbps-Gaussian- March Zehnder - 100 km at attenuation 0.2	0	55.2395	-4.724	0.00195091
35. 8 Bit-5 Gbps-Gaussian- March Zehnder - 150 km at attenuation 0.1	0.0537932	1.60901	0.276	- 0.000704604
36. 8 Bit-5 Gbps-Gaussian- March Zehnder - 150 km at attenuation 0.2	6.81811e-030	11.2663	-14.724	0.00010386
37. 8 Bit-10 Gbps-Gaussian-Electro absorption- 50 km at attenuation 0.1	1.78828e-043	13.737	10.903	0.0243504
38. 8 Bit-10 Gbps-Gaussian-Electro absorption- 50 km at attenuation 0.2	0	65.6462	5.904	0.0116006
39. 8 Bit-10 Gbps-Gaussian-Electro absorption- 100 km at attenuation 0.1	1	0	5.904	0
40. 8 Bit-10 Gbps-Gaussian-Electro absorption- 100 km at attenuation 0.2	2.22976e-006	4.57198	-4.096	0.00016008
41. 8 Bit-10 Gbps-Gaussian-Electro absorption- 150 km at attenuation 0.1	0.0627413	1.4439	0.904	-0.00108192
42. 8 Bit-10 Gbps-Gaussian-Electro absorption- 150 km at attenuation 0.2	1	0	-14.096	0
43. 8 Bit-10 Gbps-Gaussian-March Zehnder - 50 km at attenuation 0.1	3.50787e-021	9.33409	10.496	0.017457



## Chapter-4 Results and analysis

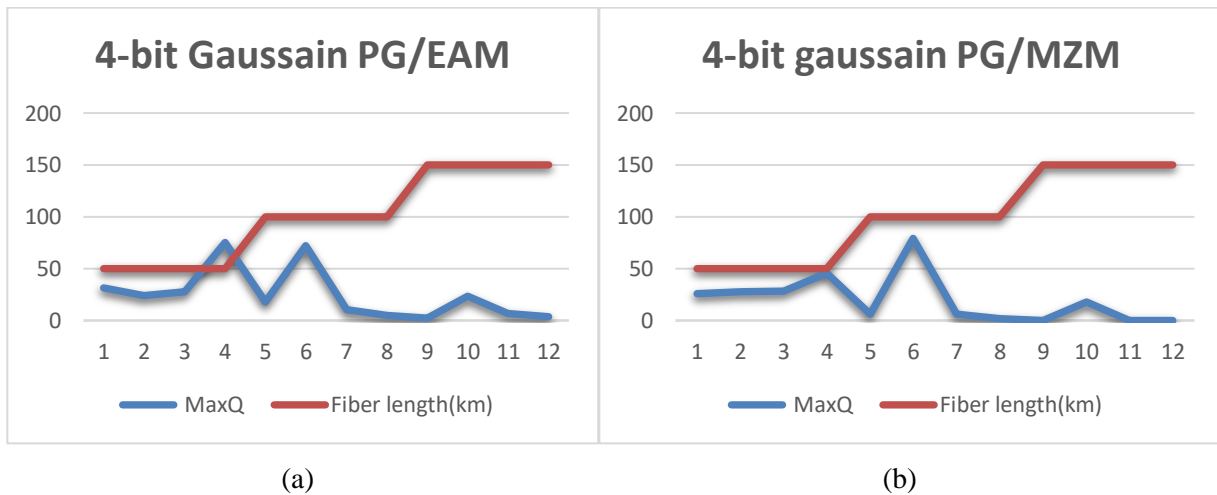
44. 8 Bit-10 Gbps-Gaussian- March Zehnder -50 km at attenuation 0.2	2.8942e-061	16.4516	5.496	0.00960161
45. 8 Bit-10 Gbps-Gaussian- March Zehnder - 100 km at attenuation 0.1	1	0	5.496	0
46. 8 Bit-10 Gbps-Gaussian- March Zehnder - 100 km at attenuation 0.2	0.0129363	2.16725	-4.503	- 0.000114987
47. 8 Bit-10 Gbps-Gaussian- March Zehnder - 150 km at attenuation 0.1	1	0	0.496	0
48. 8 Bit-10 Gbps-Gaussian- March Zehnder - 150 km at attenuation 0.2	1	0	-14.503	0

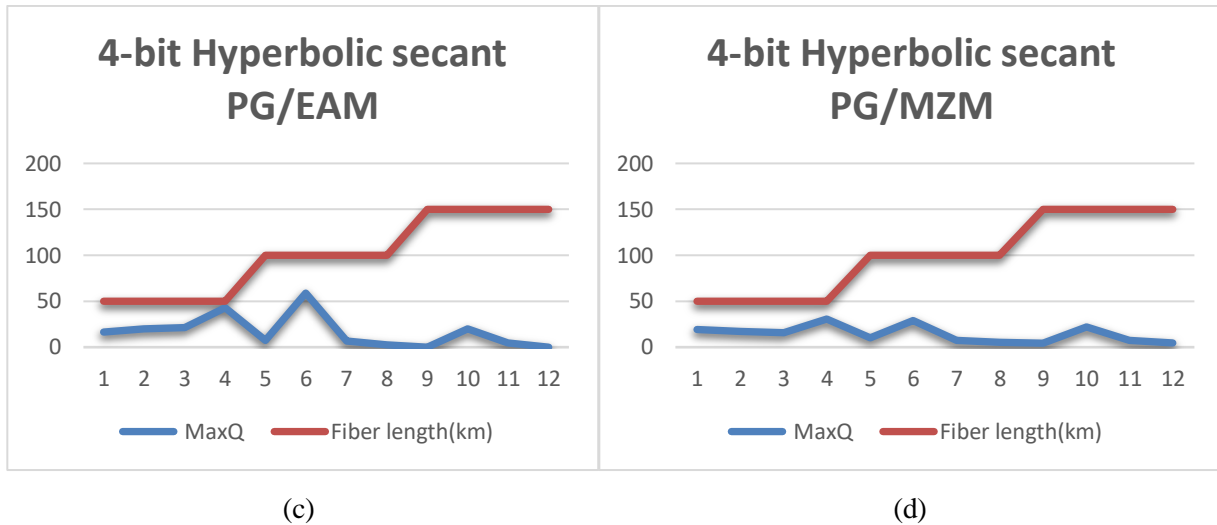
**Table-4.2** This is the data table of Gaussian pulse generator based on 4 and 8-bit sequence on various modulators, fiber length, speed & attenuation.

### 4.2 Analysis figures of different bit sequence based on all the simulations

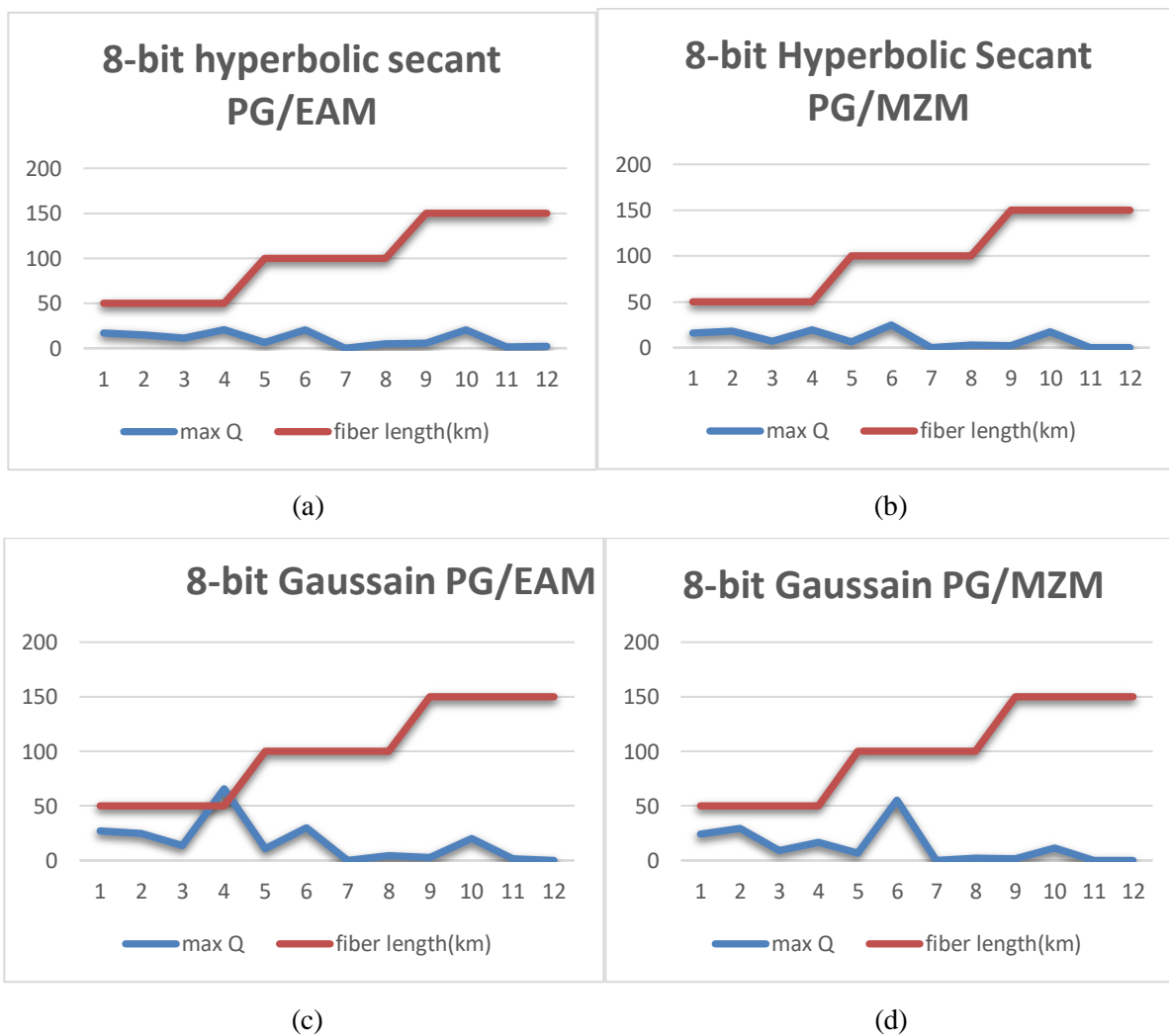
#### 4.2.1 Maximum Quality factor

A Q-factor measurement falls between traditional optical parameters (power, OSNR, and wavelength) and digital end-to-end performance parameters based on BER. A Q-factor is determined in the time domain by analyzing the statistics of the optical signal's pulse shape. A Q-factor is a comprehensive measure of an optical channel's signal quality that takes into account the effects of noise, filtering, and linear/non-linear distortions on the pulse shape, which is impossible to do using only simple optical parameters [23].



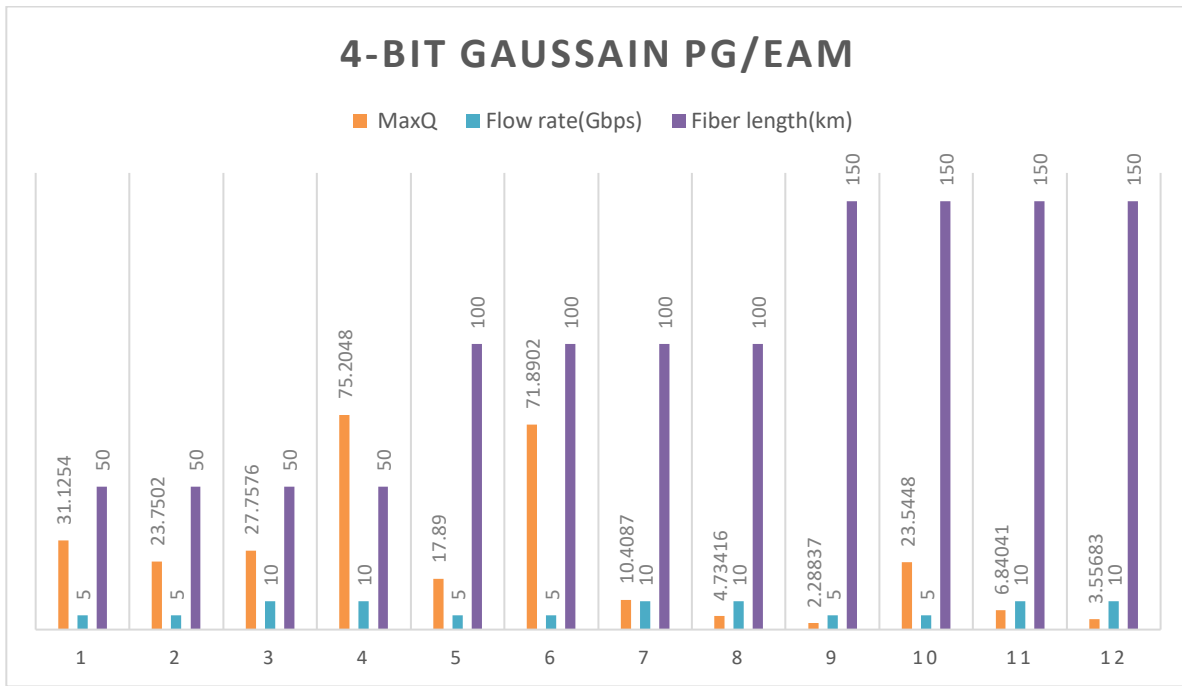


**Figure-4.1** Maximum quality factor versus various propagation distance based on 4 bits sequence value of 1010 for (a) Gaussian PG/EAM (b) Gaussian PG/MZM (c) Hyperbolic Secant PG/EAM (d) for Hyperbolic Secant PG/MZM

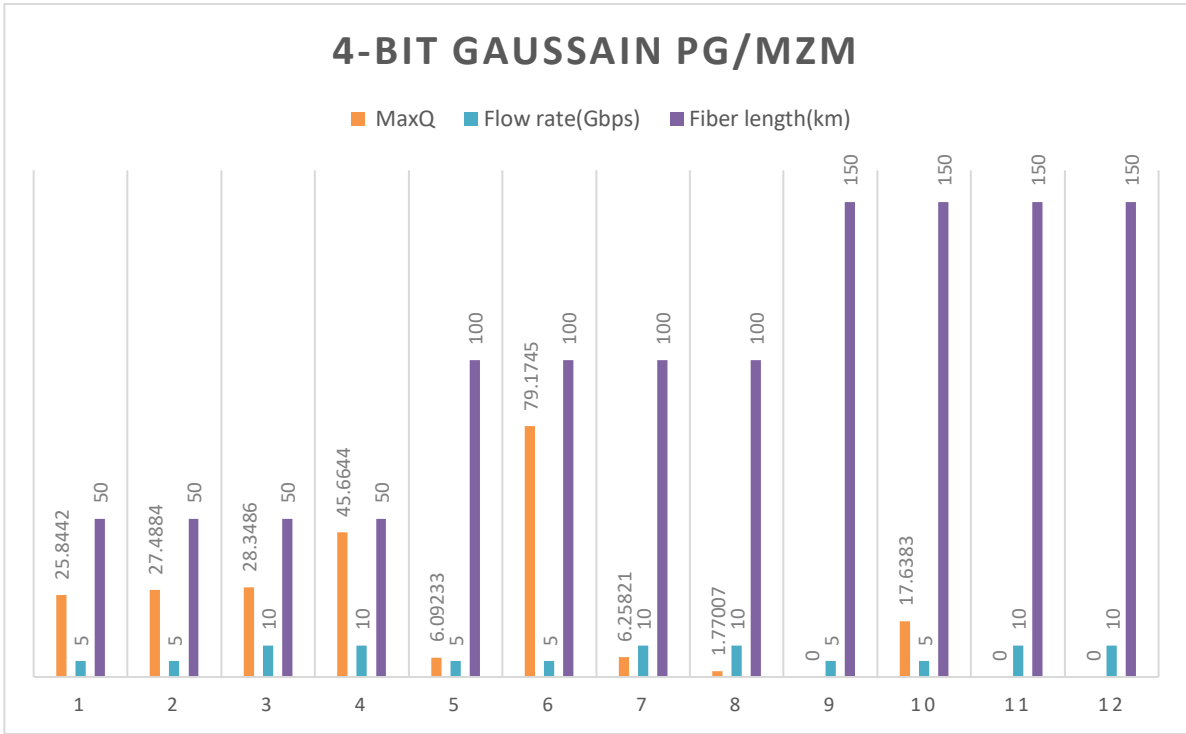


**Figure-4.2** Maximum quality factor versus various propagation distance based on 8 bits sequence value of 10101100 for (a) Gaussian PG/EAM (b) Gaussian PG/MZM (c) Hyperbolic Secant PG/EAM (d) for Hyperbolic Secant PG/MZM

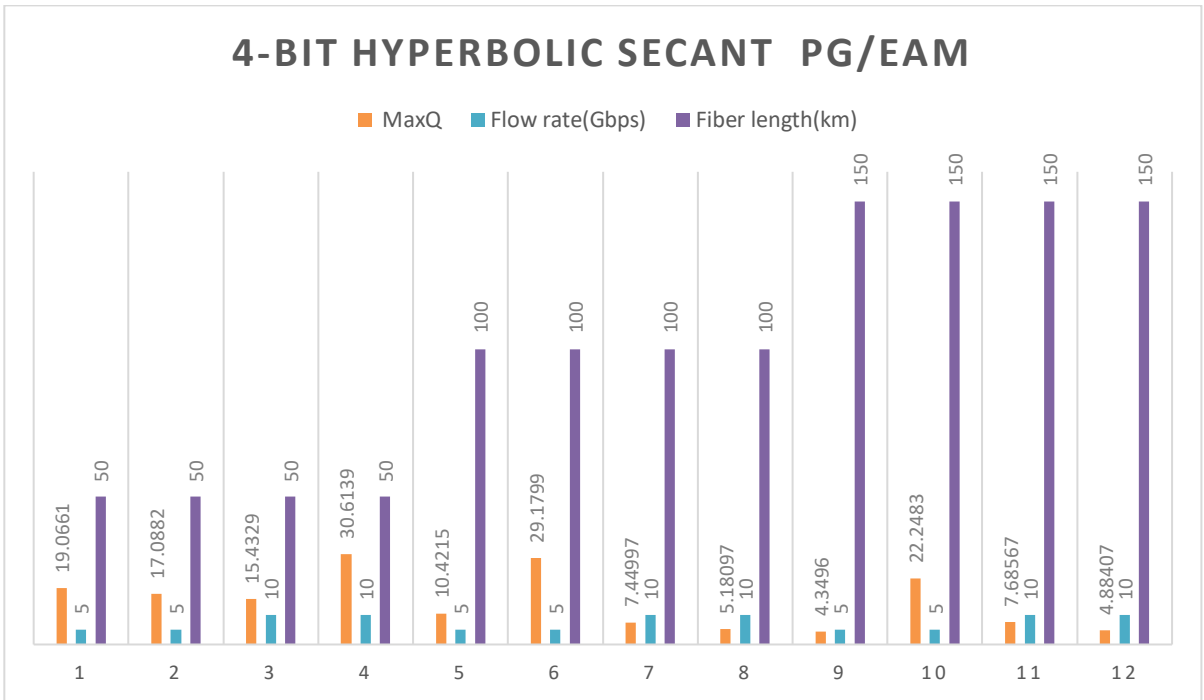
**Maximum Quality factor Vs Flow rate VS Fiber length**



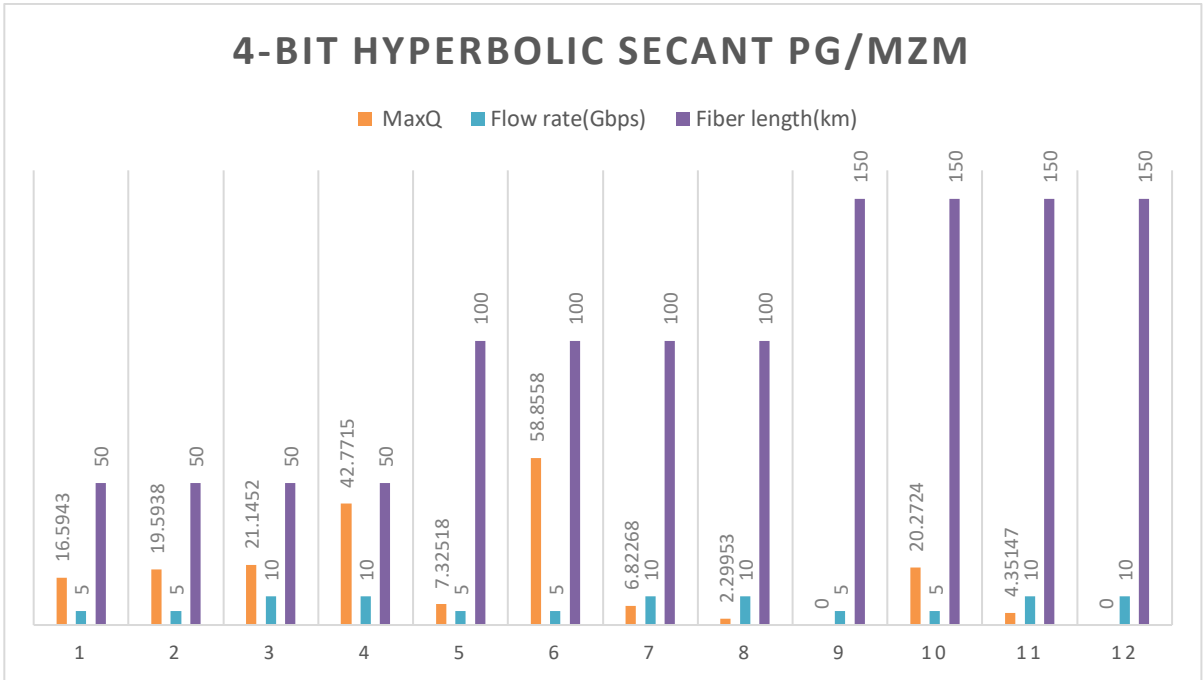
(a)



(b)

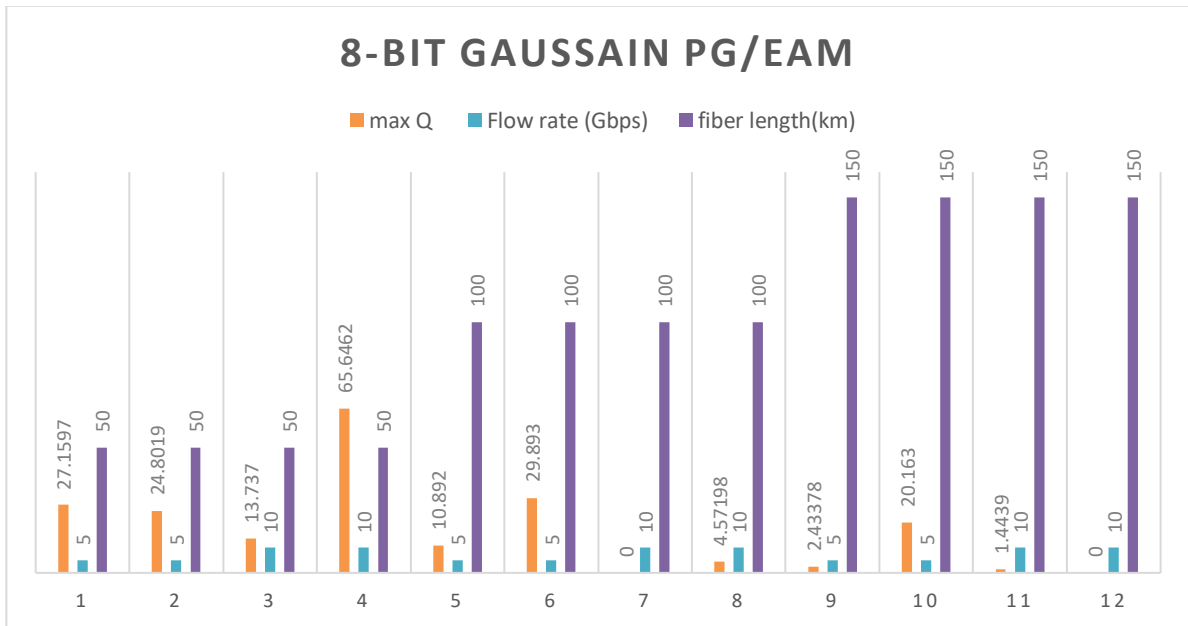


(c)

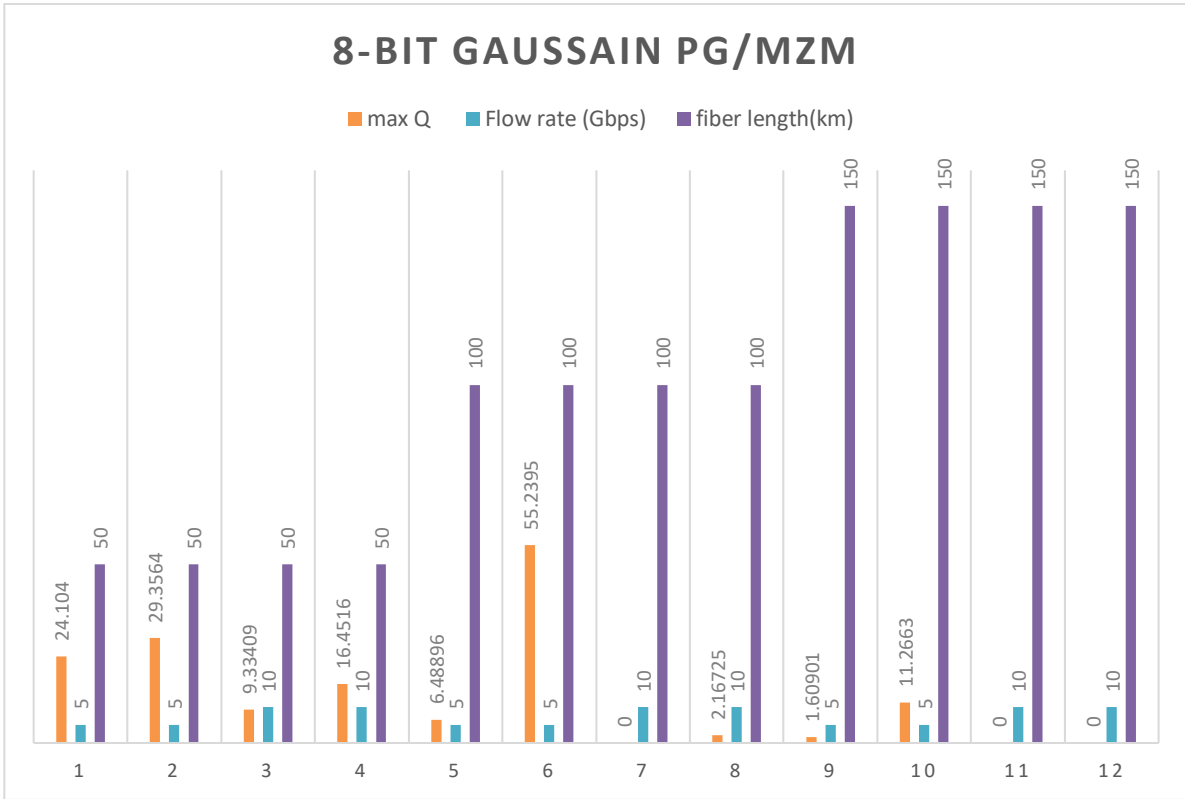


(d)

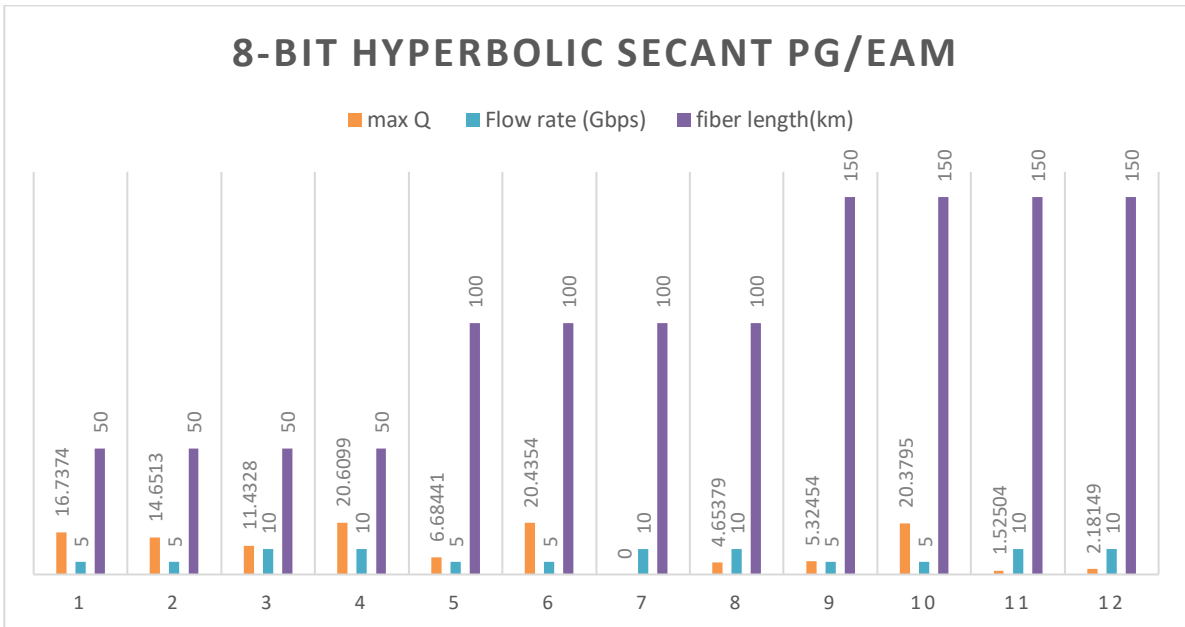
**Figure-4.3** Maximum quality factor vs flow rate vs various propagation distance based on 4 bits sequence value of 1010 for (a) Gaussian PG/EAM (b) Gaussian PG/MZM (c) Hyperbolic Secant PG/EAM (d) for Hyperbolic Secant PG/MZM



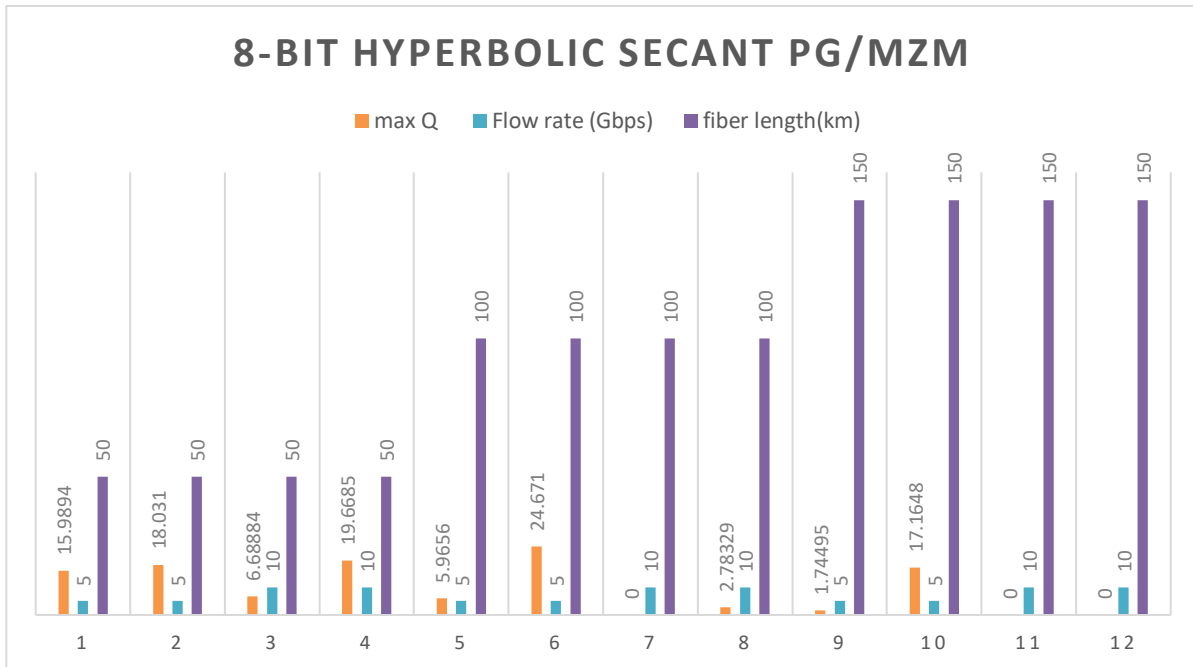
(a)



(b)



(c)



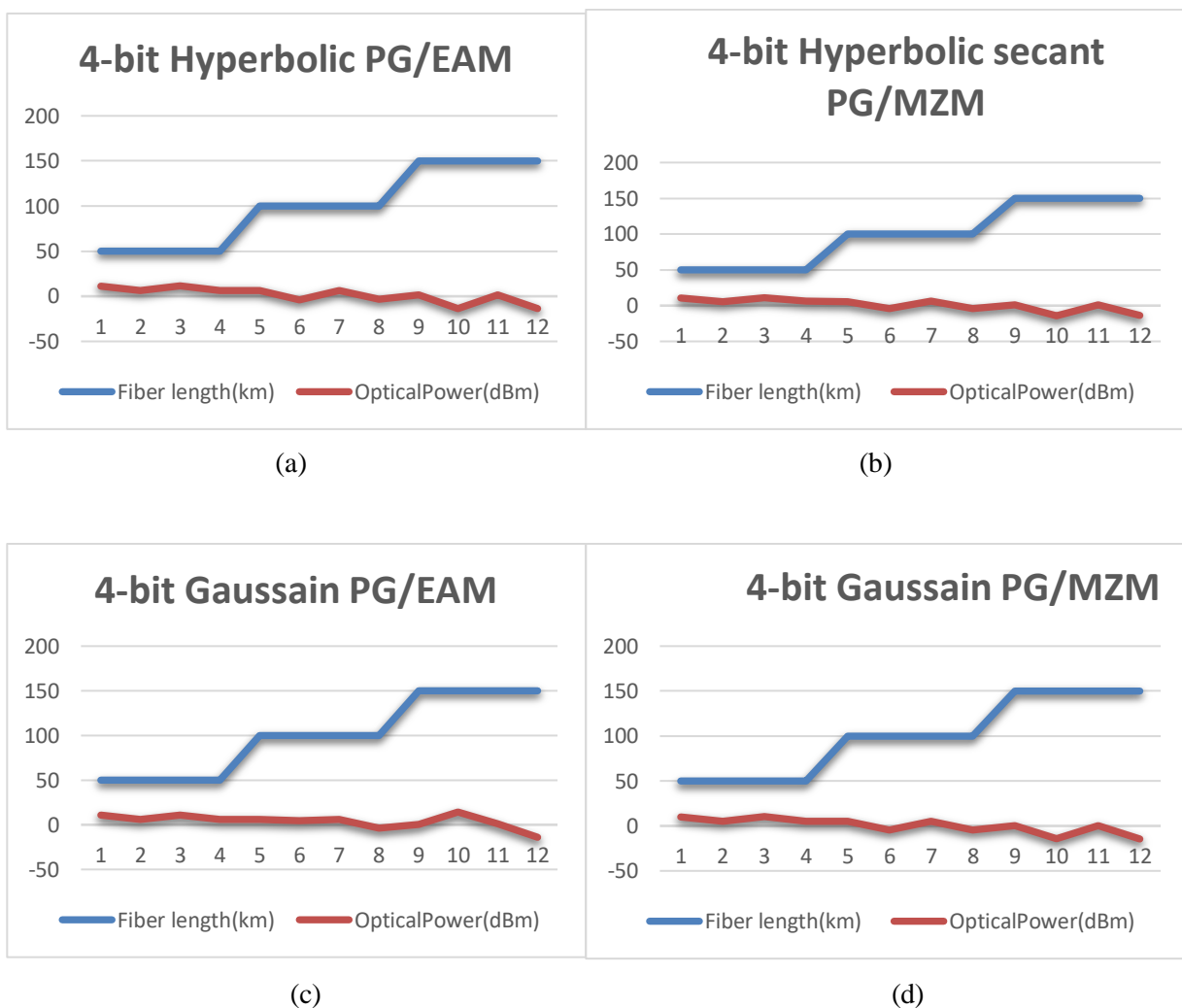
(d)

**Figure-4.4** Maximum quality factor vs flow rate vs various propagation distance based on 8 bits sequence value of 10101100 for (a) Gaussian PG/EAM (b) Gaussian PG/MZM (c) Hyperbolic Secant PG/EAM (d) for Hyperbolic Secant PG/MZM

### 4.2.2 Optical Power

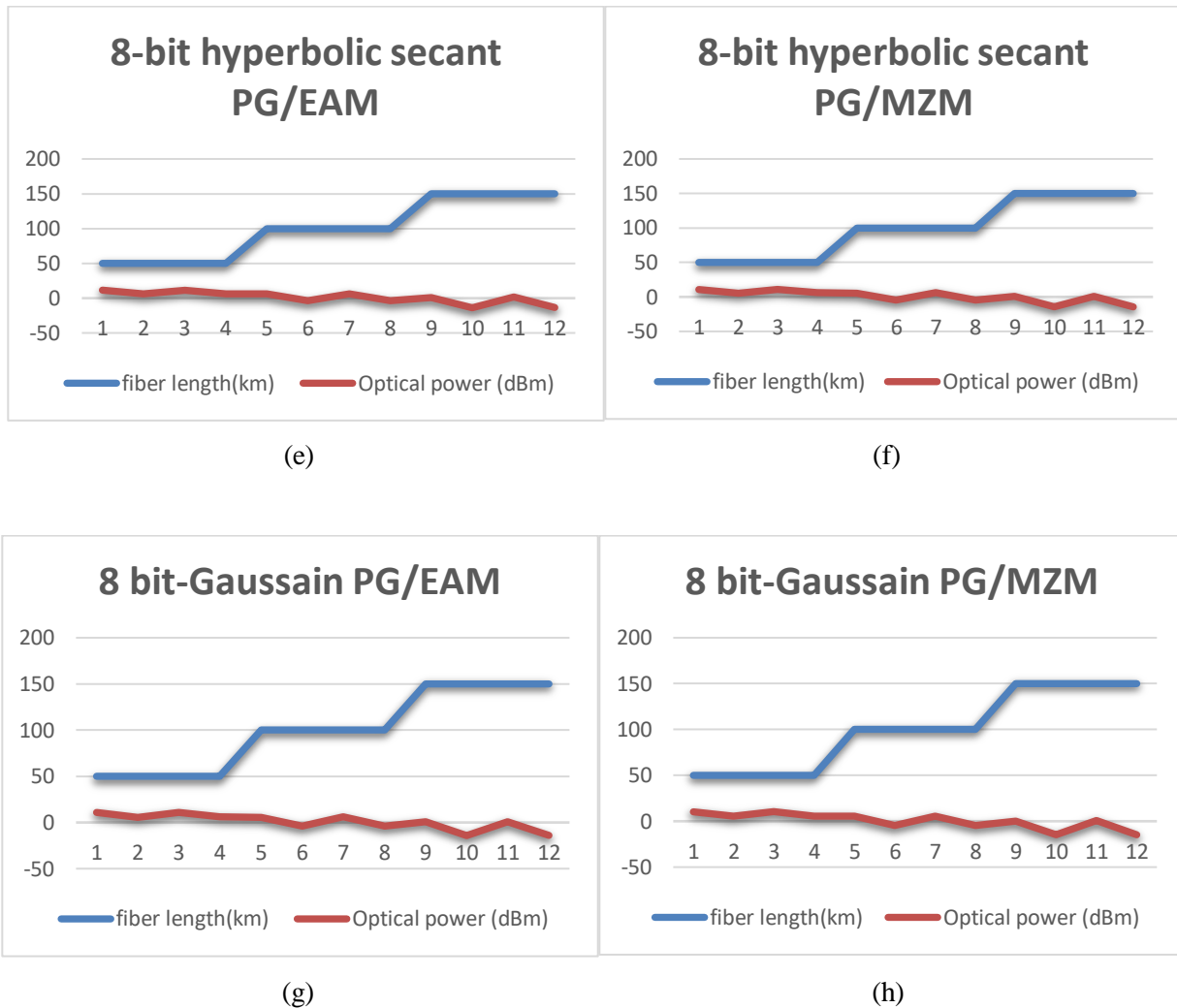
The amount of energy transported per unit time by a laser beam, or more precisely, the peak power of a focusing laser, is referred to as optical power. Laser beams' optical powers are frequently measured using so-called optical power meters. Certain of these devices are capable of handling multiple kilowatts of laser power from a high-power laser; they are typically cooled by water. Other power meters, frequently based on photodiodes, are capable of measuring optical powers as low as microwatts, nanowatts, or even lower. Optical power monitors are frequently used as integral components of optical systems, for example, in optical fiber communications. Due to the difficulty of collecting it, the optical power of light radiated in a broad range of directions is difficult to measure with a power meter. An integrating sphere can be used in these instances. It is worth noting that the optical power of some sources may be distributed over a wide frequency or wavelength range. Photodetectors (e.g., photodiodes) can have different responses at different frequencies, so it may be hard to get an accurate measurement of the total optical power because it may not be possible to get an exact reading [24].

A typical OPM has a linear output range of approximately 0 dBm (1 milli Watt) to approximately -50 dBm (10 nano Watt), although the display range may be greater. Above 0 dBm is considered "high power," and units that have been specially adapted can measure up to nearly + 30 dBm ( 1 Watt). Low power is defined as less than -50 dBm, and specially adapted units can measure as low as -110 dBm. Regardless of the power meter specifications, testing below approximately -50 dBm is frequently sensitive to ambient light leaking into fibers or connectors. Thus, when testing at "low power," some form of test range / linearity verification (which can be accomplished easily with attenuators) is recommended. At low power levels, optical signal measurements become noisy, and meters may become extremely slow as a result of extensive signal averaging.



**Figure-4.5** Optical power versus various propagation distance based on 4 bits sequence value of 1010 for (a) Gaussian PG/EAM (b) Gaussian PG/MZM (c) Hyperbolic Secant PG/EAM (d) for Hyperbolic Secant PG/MZM





**Figure-4.6** Optical power versus various propagation distance based on 8 bits sequence value of 10101100 for (a) Gaussian PG/EAM (b) Gaussian PG/MZM (c) Hyperbolic Secant PG/EAM (d) for Hyperbolic Secant PG/MZM

### 4.3 Observation & Discussion

The figures 4.1 and 4.3 illustrate the relationship between the signal's maximum quality factor and the fiber length ranges for a 4-bit sequence (1010) with Gaussian PG and Hyperbolic PG and a data flow rate of 5/10gbps. We simulated all possible combinations using a 4-bit communication system and analyzed the output values of the maximum Q-factor. This demonstrates that for a given range of fiber length, the maximum Q-factor rate increases in only a few combinations. For instance, in a 4-bit Gaussian PG/EAM-based combination, we obtained a maximum q factor of 75.2048 in the 50km range at 10gbps speed and attenuation of 0.2, which is greater than the other combinations in the 50km range.

Additionally, in the 50km range at 10gbps speed with attenuation 0.2, we obtain a max q factor of 42.7715 in the 4-bit hyperbolic secant PG/MZM.

Similarly, Figures 4.2 and 4.4 illustrate the relationship between the signal's maximum quality factor and the fiber length ranges for an 8-bit sequence (10101100) with Gaussian PG and Hyperbolic PG at 5/10gbps data flow rate.

We simulated all possible combinations using a 4-bit communication system and analyzed the output values of the maximum Q-factor. This demonstrates that for a given range of fiber length, the maximum Q-factor rate increases in only a few combinations.

For instance, in an 8-bit Gaussian PG/EAM-based combination, we obtained a maximum q factor of 65.6462 in the 50km range at 10gbps speed and attenuation of 0.2, which is greater than the other combination in the 50km range.

Additionally, in the 8-bit hyperbolic secant PG/MZM, we obtain a max q factor of 20.6099 in the 50km range at a speed of 10gbps with a 0.2 attenuation.

In section 4.2.2.1, we evaluate the graph of optical signal power versus fiber length for a four-bit sequence (1010) using Gaussian PG and Hyperbolic PG with a data flow rate of 5/10gbps.

We simulated all combinations using a 4-bit communication system, and these graphs demonstrate that increasing the fiber length has an effect on the optical signal power, which gradually decreases as the fiber length increases.

According to the graphs, in the 50km range, all combinations produce system power greater than 0dbm, which is a significant amount of power. However, in the 150km range, all combinations produce system power less than 0dbm, which is a very low level of power.

Similarly, in Figure 4.2.2.2, we see the same thing happen when we evaluate the graph of optical signal power vs fiber length for an 8-bit sequence (10101100) using Gaussian PG and Hyperbolic PG with 5/10gbps data flow rate.

When the optical signal power of all possible combinations in a 4bit/8bit sequence is compared, the hyperbolic secant PG/EAM demonstrates outstanding performance.

### **4.4 Comments on result**

After comparing all of the combination data we got from simulation and analysis, we can say that for maximum quality factor ratio, 4-bit Gaussian PG/EAM based communication systems work stable and better performance in high-speed data flow rates. 8-bit Gaussian PG/EAM-based communication systems, on the other hand, perform better in the 50–100 km range fiber lengths, and 8-bit hyperbolic secant/EAM-based systems perform well in the 150km range fiber lengths. Basis of optical signal power, 4 & 8-bit hyperbolic/EAM based systems show more stable performance than other combination-based systems.

# **Chapter-5**

## **Conclusion**

### **5.1 Conclusion**

In summary, the efficient coupling between proposed electrical pulse signal generators and optical modulators is suggested in optical access transmission networks. Based on the numerical simulation, the maximum quality factor is degraded with the increase of distance. The maximum Q-factor value and maximum optical signal power are estimated for proposed pulse generators with different optical modulators. For different bit sequences, it is discovered that the Gaussian pulse generator/EAM has a higher maximum Q-factor value and optical signal power than either of the proposed pulse generators/EA. Furthermore, hyperbolic-secant PG/EAM outperformed proposed pulse generator for 8-bit sequence in terms of maximum Q-factor value optical signal power. Therefore, it is recommended to use Gaussian PG/EAM for different bit sequences in all overall. For better signal power for 8-bit sequences for high-speed transmission networks, Hyperbolic-secant PG/EAM is used.

### **5.2 Purpose of this work**

Purpose of this work is to design a digital fiber-optic communication link. The proposed structure yields beneficial results when applied to optical communication links. We investigated various pulse generators such as the Gaussian and Hyperbolic secant pulse generators, as well as modulators, such as the march Zander and electro absorption modulators, and their factors. After simulating the proposed structure in Opti system software, we reach a conclusion. Additionally, the proposed structure has demonstrated significant performance for specific pulse generators in various bit sequences. As a result, it is anticipated that the proposed high-speed hyperbolic and Gaussian pulse generators with electro-optic modulators based on different bit sequences for digital fiber optic communication link-based research will contribute to the acceleration of the digital optical communication system. Yields beneficial results when applied to optical communication links. We investigated various pulse generators such as the Gaussian and Hyperbolic secant pulse generators, as well as modulators, such as the march Zander and electro absorption modulators, and their factors. After simulating the proposed structure in Opti system software, we reach a conclusion. Additionally, the proposed structure has demonstrated significant performance for specific pulse generators in various bit sequences. As a result, it is anticipated that the proposed high-speed hyperbolic and Gaussian pulse generators with electro-optic modulators based on different bit sequences for digital fiber optic communication link-based research will contribute to the acceleration of the digital optical communication system.

## *Reference*

---

---

- [1] Dr. Shehab A. Kadhim, Dr. Zeyad A. Saleh, Asmaa M. Raouf, "Performance Evaluation of Experimental Digital Optical Fiber Communication Link", A High Impact Factor, Monthly, Peer Reviewed Journal, Vol. 6, Issue 10, October 2017.
- [2] Mahmoud M.A. Eid, Ashraf S. Seliem, Ahmed Nabih Zaki Rashed, Abd El-Naser A. Mohammed, Mohamed Yassin Ali and Shaimaa S. Abaza, "High speed pulse generators with electro-optic modulators based on different bit sequence for the digital fiber optic communication links", Indonesian Journal of Electrical Engineering and Computer Science vol. 21, No. 2, February 2021, pp. 957~967.
- [3] Pu Li, Yun-Cai Wang and Jian-Zhong Zhang, "All-optical fast random number generator", 2010 Optical Society of America.
- [4] OptiSystem Tutorials, Optical Communication System Design Software version 13, vol. 1, pp. 1-500, 2014, [https://dru5cjjfivrg.cloudfront.net/wp-content/uploads/2015/03/OptiSystem\\_Tutorials\\_Volume\\_1.pdf](https://dru5cjjfivrg.cloudfront.net/wp-content/uploads/2015/03/OptiSystem_Tutorials_Volume_1.pdf)
- [5] Md. Mobarok Hossain Rubel, Syed Golam Mahmud, "BER Performance Analysis for Optical Communication using DPSK Modulation", International Journal of Computer Applications (0975 – 8887) Volume 59– No.9, December 2012.
- [6] Mimouna Oukli, Malika Kandouci, Meriem Bouzid, Abdelber Bendaoud, "Study and Optimization of High-Bit Rate Optical Fiber Transmission", Serbian Journal of Electrical Engineering Vol. 5, No. 2, November 2008, 361-370.
- [7] Sunita Arya, David Joseph, "A Study Performance of L- Band Optical Communication System for NRZ and RZ Format", International Journal of Physical, Chemical & Mathematical Sciences, Vol. 4; No. 1: ISSN: 2278-683X (Jan–June 2015).
- [8] Wissam Mahjoob Osman, Khalid Hamed Billal and Amin Babiker Al Nabi, "Bit Error Rate Performance for Optical Fiber System", Osman et al., J Electr Electron Syst 2018.
- [9] Jahangir Alam S. M., M. Rabiul Alam, Hu Guoqing, and Md. Zakirul Mehrab, "Improvement of Bit Error Rate in Fiber Optic Communications", International Journal of Future Computer and Communication, Vol. 3, No. 4, August 2014.

## Reference

---

- [10] Saikat Saha, Pratham Majumder, Myneni Soundarya, “Optimization Of Gain And Bit Error Rate Of An Erbium Doped Fiber Amplifier For Wdm System”, International Journal of Engineering Research & Technology (IJERT) Vol. 2 Issue 8, August – 2013.
- [11] Salah Alabady, “Simulation and Best Design of an Optical Single Channel in Optical Communication Network”, International Arab Journal of e-Technology, Vol. 2, No. 2, June 2011.
- [12] Hrishikesan, S., & Complete Profile, V. M. (2019, September 28). *Optical Fiber Communication System Block Diagram - Electronics And Communication Study Materials*. Electronics and Communication Study Materials.<https://www.electronicandscommunications.com/2019/09/optical-fiber-communication-system.html>.
- [13] Fiber Optic Communication System : Basic Elements & Its Working. (2014, March 6). ElProCus - Electronic Projects for Engineering Students.  
<https://www.elprocus.com/basic-elements-of-fiber-optic-communication-system-and-its-working/>.
- [14] Potter, D. (2017, January 1). [PDF] *Module 3-Attenuation In Optical Fibers | Semantic Scholar*. [PDF] Module 3-Attenuation in Optical Fibers | Semantic Scholar.  
<https://www.semanticscholar.org/paper/Module-3-Attenuation-in-Optical-Fibers-Potter/8215cb3315dbf05295d991e5f48542fd2ea23895>.
- [15] Shuravi, K. S. (2016). Optical Fiber - Dispersion, Construction, Application, Technology, Future. *Optical Fiber - Dispersion, Construction, Application, Technology, Future*, 0–11. 10.13140/RG.2.1.4009.8961.
- [16] Hrishikesan, S., & Complete Profile, V. M. (2019, June 2). *Pulse Generator Block Diagram And Explanation - Electronics And Communication Study Materials*. Electronics and Communication Study Materials.  
<https://www.electronicandscommunications.com/2019/06/pulse-generator-block-diagram-and.html>.
- [17] CW Laser Basics And Technologies. (n.d.). CW Laser Basics and Technologies.  
<https://www.laserlabsource.com/Solid-State-Lasers/cw-laser-basics>.

## Reference

---

- [18] Optical Modulator | Timbercon. (n.d.). Timbercon.  
<https://www.timbercon.com/resources/glossary/optical-modulator/>.
- [19] What Is a Mach-Zehnder Modulator And How Does It Work? | Synopsys. (n.d.). What is a Mach-Zehnder Modulator and How Does it Work? | Synopsys.  
<https://www.synopsys.com/glossary/what-is-a-mach-zehnder-modulator.html>.
- [20] Paschotta, D. R., & Paschotta, D. R. (n.d.). *Electroabsorption Modulators, Explained By RP Photonics Encyclopedia; Electro-absorption Modulator, Franz-Keldysh Effect*. Electroabsorption modulators, explained by RP Photonics Encyclopedia; electro-absorption modulator, Franz-Keldysh effect. [https://www.rp-photonics.com/electroabsorption\\_modulators.html](https://www.rp-photonics.com/electroabsorption_modulators.html).
- [21] Filters - Classification, Characteristics, Types, Applications & Advantages. (2019, August 8). electricalfundablog.com. <https://electricalfundablog.com/filters-classification-characteristics/?fbclid=IwAR3-iir3NAaJUqf715mG5k5j5EmtBVYQRT0O4uCsXz-ZJsBKGAIwyzX-u4w>.
- [22] PIN Photodetector Characteristics for Optical Fiber Communication & Fosco Connect. (2011, February 15). Fosco Connect.  
<https://www.fiberoptics4sale.com/blogs/archive-posts/95046662-pin-photodetector-characteristics-for-optical-fiber-communication>.
- [23] What Is Q-factor And What Is Its Importance?. (2014, June 17). What is Q-factor and what is its importance? | MapYourTech.com.  
<https://mapyourtech.com/entries/general/what-is-q-factor-and-what-is-its-importance->.
- [24] Paschotta, D. R., & Paschotta, D. R. (n.d.). *Optical Power, Explained By RP Photonics Encyclopedia; Watts, DBm, Focusing Power, Dioptric Power, Radiant Power, Refractive Power*. Optical power, explained by RP Photonics Encyclopedia; watts, dBm, focusing power, dioptric power, radiant power, refractivepower. [https://www.rp-photonics.com/optical\\_power.html#:~:text=The%20term%20optical%20power%20occurs,a%20lens%20or%20microscope%20objective..](https://www.rp-photonics.com/optical_power.html#:~:text=The%20term%20optical%20power%20occurs,a%20lens%20or%20microscope%20objective..)