

Optimum compact array antenna design using folded feed configuration

By

Ezaz Ahmad
Sadia Alam
S.M. Yusuf Ahmed

Submitted to the

Department of Electrical and Electronic Engineering
Faculty of Sciences and Engineering
East West University

In partial fulfillment of the requirements for the degree of
Bachelor of Science in Electrical and Electronic Engineering
(B.Sc. in EEE)
[Summer, 2009]

Approved By



Thesis Advisor

Dr. Ishfaqur Raza

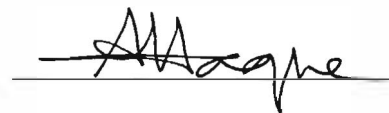

Chairperson

Dr. Anisul Haque

ABSTRACT

Since micro strip array antenna helps to provide reasonable gain and ease of management of the antennas, so the array antenna is widely used in real applications. Optimum array antenna needs to have minimum impedance mismatch between the antennas and the feed lines, to reduce return loss. To remove the impedance mismatch the width of the feed lines and transmission lines need to be tuned across the network of feed lines. However, larger array tend to take up a lot of space due the network of feed lines in a large antenna array setup.

In this thesis a folding of the feed networks is reviewed to minimize the area taken up by an array. The microstrip patch is used as the antenna of choice for reviewing the feed design. Sharp turn with 90 degree feed will introduce mismatches; hence two other kinds of turns, mitered and curved turns are investigated. We have also reviewed the impact of large width feed lines which themselves start resonating, creating undesirable resonances. Quarter wave transformers have been used in the proposed design to perform the matching requirements. The designs were optimized to keep the width of the feed networks to a reasonable value.

Considering the reduction of impedance mismatch with different forms of turns, we have designed an optimum Patch Antenna and we applied that antenna in the Array. We have considered various types of design process and by verifying those design we have selected the best configuration for the feed line network.

ACKNOWLEDGEMENTS

We would like to express our deep gratefulness and admiration to our supervisor Md. Ishfaqur Raza, PhD, Associate Professor of the Electrical And Electronics Engineering, Department of East West University, for his outstanding direction and encouragement. The thesis completion is a result of his unparalleled support and concern.

Special thanks to Dr. Anisul Haque, Chairperson EEE of East West University for his guidelines, support and care. We also thank all the respected teachers of EEE department of East West University for their continuous inspiration and support.

We are grateful to our family members and friends for being there when we needed their assistance. Above everything we thank our Almighty, Allah, for giving us the ability, knowledge, patience and energy to complete this commitment efficiently.



AUTHORIZATION PAGE

We hereby declare that we are the sole author of this thesis. We authorize East West University to lend this thesis to other institutions or individuals for the purpose of scholarly research.

Ezaz Ahmad

Ezaz Ahmad

Sadia Alam

Sadia Alam

S.M. YUSUF AHMED

S.M. Yusuf Ahmed

We further authorize East West University to reproduce this thesis by photocopy or other means, in total or in part, at the request of other institutions or individuals for the purpose of scholarly research.

Ezaz Ahmad

Ezaz Ahmad

Sadia Alam

Sadia Alam

S.M. YUSUF AHMED

S.M. Yusuf Ahmed

TABLE OF CONTENTS

| | |
|--|-----------|
| ABSTRACT..... | 2 |
| ACKNOWLEDGEMENTS..... | 3 |
| AUTHORIZATION PAGE..... | 4 |
| TABLE OF CONTENTS..... | 5 |
| LIST OF ILLUSTRATIONS..... | 7 |
| LIST OF TABLES..... | 9 |
| 1. INTRODUCTION..... | 10 |
| 1.1. THESIS MOTIVATION..... | 10 |
| 1.2. LITERATURE REVIEW..... | 11 |
| 1.3. THESIS REVIEW..... | 12 |
| 2. BACKGROUND THEORY..... | 13 |
| 2.1. ANTENNA SYSTEM..... | 13 |
| 2.2. DIFFERENT ANTENNAS..... | 13 |
| 2.2.1. <i>Categorization of antennas</i> | 13 |
| 2.3. MICROSTRIP PATCH ANTENNA..... | 16 |
| 2.3.1. <i>Application of patch antenna</i> | 17 |
| 2.4. ANTENNA ARRAYS..... | 18 |
| 2.4.1. <i>Uses of antenna arrays</i> | 18 |
| 3. ANTENNA ANALYSIS..... | 20 |
| 3.1. CRITICAL ANTENNA PARAMETERS..... | 20 |
| 3.2. ANTENNA MODELING..... | 21 |
| 3.2.1. <i>Transmission-Line Model</i> | 21 |
| 3.2.2. <i>Cavity Model</i> | 23 |
| 3.2.3. <i>TM mode</i> | 24 |
| 4. FOLDED ANTENNA ARRAY FEED..... | 25 |
| 4.1. MICROSTRIP PATCH ANTENNA ARRAYS FOR 12.8 GHZ..... | 25 |
| 4.2. ELIMINATION OF THE IMPEDANCE MISMATCH..... | 25 |
| 4.3. THE OPTIMUM FEED POSITION..... | 26 |
| 4.4. DIFFERENT CONFIGURATION OF FEED LINE..... | 26 |
| 4.4.1. <i>Symmetric width of the feed line</i> | 26 |
| 4.4.2. <i>Impedance matching varying the feed line width</i> | 27 |
| 4.5. QUARTER WAVE DESIGN..... | 29 |
| 4.5.1. <i>Design of an 1 x 2 array using quarterwave</i> | 30 |
| 4.5.2. <i>Design of 2 X 2 Array using quarterwave</i> | 30 |
| 4.5.3. <i>Array Design 2 x 4 using quarterwave</i> | 31 |
| 4.6. OUR PROPOSAL..... | 32 |
| 4.6.1. <i>Folded Quarterwave in order to reduce the Length</i> | 32 |
| 4.6.2. <i>Curved Turns Folded Quarterwave</i> | 34 |
| 4.6.3. <i>Mitered Turns Folded Quarterwave</i> | 35 |
| 4.7. CHANGES IN FOLDED QUARTER WAVE TRANSFORMER LENGTH..... | 37 |
| 4.7.1. <i>Increment in the Length of Quarterwave by 5%</i> | 37 |

Undergraduate Thesis

| | | |
|----------|--|-----------|
| 4.7.2 | <i>Decrement in the Length of Quarter wave by 5%</i> | 37 |
| 4.8 | ARRAY ANTENNA USING FOLDED QUARTER WAVE: 2 X 4..... | 38 |
| 5 | SIMULATION AND RESULTS | 39 |
| 5.1 | FEED POSITION OPTIMIZATION | 40 |
| 5.2 | SECONDARY RESONANCE IN 1 X 2 ARRAY ANTENNA | 41 |
| 5.3 | SECONDARY RESONANCE IN 2 X 2 ARRAY ANTENNA | 42 |
| 5.4 | VARYING FEED WIDTH | 42 |
| 5.5 | $\lambda/4$ WAVE TRANSFORMER IN 1 X 2 ARRAY ANTENNA..... | 43 |
| 5.6 | QUARTER WAVE TRANSFORMER FOR 2 X 2 AND 2 X 4 ARRAY..... | 44 |
| 5.7 | FOLDED QUARTER WAVE ARRAY DESIGN 1 X 2, 2 X 2..... | 45 |
| 5.8 | FOLDED QUARTER WAVE ARRAY WITH CURVED TURNS | 46 |
| 5.9 | FOLDED QUARTER WAVE ARRAY WITH MITERED TURNS..... | 47 |
| 5.10 | VARIED LENGTHS OF FOLDED QUARTER WAVE SECTIONS..... | 48 |
| 5.11 | COMPARISON OF ROUNDED AND MITERED TURNS | 49 |
| 6 | CONCLUSION | 50 |
| 7 | FUTURE WORK | 51 |
| | REFERENCES | 52 |
| | APPENDIX | 53 |

LIST OF ILLUSTRATIONS

| | |
|---|----|
| FIGURE 1: ANTENNA SYSTEM..... | 13 |
| FIGURE 2: WIRE ANTENNA CONFIGURATION | 14 |
| FIGURE 3: APERTURE ANTENNA CONFIGURATION..... | 14 |
| FIGURE 4: MICROSTRIP ANTENNAS | 14 |
| FIGURE 5: ARRAY ANTENNAS | 15 |
| FIGURE 6: REFLECTOR ANTENNAS | 15 |
| FIGURE 7: LENS ANTENNA CONFIGURATION..... | 16 |
| FIGURE 8: MICROSTRIP PATCH ANTENNA..... | 16 |
| FIGURE 9: MICROSTRIP PATH ANTENNA..... | 17 |
| FIGURE 10: (A) SINGLE PATCH, (B) RETURN LOSS VERSUS FREQUENCY CURVE FOR SINGLE PATCH ANTENNA | 18 |
| FIGURE 11: (A) PATCH ARRAY, (B) RETURN LOSS VERSUS FREQUENCY CURVE FOR PATCH ARRAY ANTENNA..... | 18 |
| FIGURE 12: RESONANT FREQUENCY..... | 20 |
| FIGURE 13: LUMPED LOSSY TRANSMISSION LINE MODEL | 22 |
| FIGURE 14: FRINGING | 22 |
| FIGURE 15: ELECTRIC FIELD LINES..... | 23 |
| FIGURE 16: CHARGE DISTRIBUTION AND CURRENT DENSITY CREATION ON MICROSTRIP ANTENNA..... | 23 |
| FIGURE 17: MICROSTRIP PATCH ANTENNA | 25 |
| FIGURE 18: MICROSTRIP PATCH ANTENNA WITH NEW FEED LINE WIDTH..... | 25 |
| FIGURE 19: MICROSTRIP PATCH ANTENNA HAVING OPTIMUM FEED POSITION | 26 |
| FIGURE 20: 1X2 MICROSTRIP ARRAY ANTENNA WITH SYMMETRIC FEED LINE..... | 27 |
| FIGURE 21: 2X2 MICROSTRIP ARRAY ANTENNAS WITH SYMMETRIC LINE FEED | 27 |
| FIGURE 22: 1X2 MICROSTRIP PATCH ANTENNA USING SPLITTING TRANSMISSION LINE FEED..... | 28 |
| FIGURE 23: 2X2 MICROSTRIP ARRAY ANTENNAS USING SPLITTING TRANSMISSION LINE FEED | 28 |
| FIGURE 24: QUARTERWAVE | 29 |
| FIGURE 25: QUARTERWAVE WE DESIGNED | 29 |
| FIGURE 26: LINECALC OPTION OF ADS TO FIND THE CHARACTERISTIC IMPEDANCE OF THE QUARTERWAVE..... | 29 |
| FIGURE 27: 1X2 PATCH ARRAY ANTENNA USING QUARTERWAVE..... | 30 |
| FIGURE 28: 2X2 PATCH ARRAY ANTENNA USING QUARTERWAVE..... | 30 |
| FIGURE 29: 2X4 PATCH ARRAY ANTENNA USING QUARTERWAVE..... | 31 |
| FIGURE 30: FOLDED QUARTERWAVE..... | 32 |
| FIGURE 31: 1X2 PATCH ARRAY ANTENNA USING FOLDED QUARTERWAVE | 32 |
| FIGURE 32: 2X2 PATCH ARRAY ANTENNA USING FOLDED QUARTERWAVE | 33 |
| FIGURE 33: CURVED TURNS FOLDED QUARTERWAVE..... | 34 |
| FIGURE 34: 1X2 PATCH ARRAY ANTENNA USING CURVED TURNS FOLDED QUARTERWAVE | 34 |
| FIGURE 35: 2X2 PATCH ARRAY ANTENNA USING CURVED TURNS FOLDED QUARTERWAVE | 35 |
| FIGURE 36: MITERED TURNS FOLDED QUARTERWAVE | 35 |
| FIGURE 37: 1X2 PATCH ARRAY ANTENNA USING MITERED TURNS FOLDED QUARTERWAVE | 36 |
| FIGURE 38: 2X2 PATCH ARRAY ANTENNA USING MITERED TURNS FOLDED QUARTERWAVE | 36 |
| FIGURE 39: 2X2 PATCH ARRAY ANTENNA USING THE QUARTERWAVE WHICH HAS THE LENGTH INCREASES BY 5% | 37 |
| FIGURE 40: 2X2 PATCH ARRAY ANTENNA USING THE QUARTERWAVE WHICH HAS THE LENGTH DECREASES BY 5% | 37 |
| FIGURE 41: 2X4 ARRAY | |
| FIGURE 42: 2X4 ARRAY ANTENNA USING MITERED TURNS FOLDED QUARTERWAVE | 38 |
| FIGURE 43: RETURN LOSS VERSUS FREQUENCY CURVE FOR PATCH ARRAY ANTENNA..... | 39 |
| FIGURE 44: RETURN LOSS VERSUS FREQUENCY CURVE AFTER CHANGING THE FEED WIDTH | 40 |
| FIGURE 45: GROUP OF CURVES FOR FINDING THE OPTIMUM FEED POSITION | 40 |
| FIGURE 46: SIMULATION RESULT FOR OPTIMUM FEED POSITION | 41 |
| FIGURE 47: SIMULATION RESULT OF 1X2 ARRAY ANTENNA USING SYMMETRIC LINE FEED | 41 |
| FIGURE 48: SIMULATION RESULT OF 1X2 ARRAY ANTENNA USING SYMMETRIC LINE FEED..... | 42 |
| FIGURE 49: SIMULATION RESULT OF 1X2 ARRAY ANTENNA USING SPLITTING TRANSMISSION LINE FEED | 42 |
| FIGURE 50: SIMULATION RESULT OF 2X2 ARRAY ANTENNA USING SPLITTING TRANSMISSION LINE FEED..... | 43 |
| FIGURE 51: SIMULATION RESULT OF 1X2 ARRAY ANTENNA USING QUARTERWAVE | 43 |
| FIGURE 52: SIMULATION RESULT OF 2X2 ARRAY ANTENNA USING QUARTERWAVE | 44 |

Undergraduate Thesis

| | |
|---|----|
| FIGURE 53: SIMULATION RESULT OF 2X4 ARRAY ANTENNA USING QUARTERWAVE | 44 |
| FIGURE 54: SIMULATION RESULT OF 1X2 ARRAY ANTENNAS USING FOLDED QUARTERWAVE | 45 |
| FIGURE 55: SIMULATION RESULT OF 2X2 ARRAY ANTENNAS USING FOLDED QUARTERWAVE | 45 |
| FIGURE 56: SIMULATION RESULT OF 1X2 ARRAY ANTENNA USING CURVED TURNS FOLDED QUARTERWAVE..... | 46 |
| FIGURE 57: SIMULATION RESULT OF 2X2 ARRAY ANTENNA USING CURVED TURNS FOLDED QUARTERWAVE..... | 46 |
| FIGURE 58: SIMULATION RESULT 1X2 ARRAY ANTENNA USING MITERED TURNS FOLDED QUARTERWAVE..... | 47 |
| FIGURE 59: SIMULATION RESULT OF 2X2 ARRAY ANTENNA USING MITERED TURNS FOLDED QUARTERWAVE..... | 47 |
| FIGURE 60: SIMULATION RESULT OF FOLDED QUARTERWAVE AFTER INCREASING THE LENGTH BY 5%..... | 48 |
| FIGURE 61: SIMULATION RESULT OF FOLDED QUARTERWAVE AFTER DECREASING THE LENGTH BY 5%..... | 48 |
| FIGURE 62: SIMULATION RESULT OF 2X4 ARRAY ANTENNA USING CURVED TURNS FOLDED QUARTERWAVE | 49 |
| FIGURE 63: SIMULATION RESULT OF 2X4 ARRAY ANTENNA USING MITERED TURNS FOLDED QUARTERWAVE..... | 49 |
| FIGURE 64: QUARTER-WAVE DESIGN IN ADS | 55 |

LIST OF TABLES

| | |
|---|----|
| TABLE 1: APPLICATION OF MICROSTRIP ANTENNA..... | 17 |
| TABLE 2: FEED POSITION OPTIMIZATION..... | 26 |

1. INTRODUCTION

1.1. Thesis Motivation

Array antenna design is not a new concept. Various works have been done on it. Currently, array antennas are being used in lots of applications such as radars, communication, ultrasound machines, sonar etc. Thus, the need exists to make these antennas affordable and multipurpose. It helps to improve gain and bandwidth, increase antenna capacity and give some other advantages if we use array antennas rather than using one antenna. But if we place many antennas in array, requires more space. The trend now is to make everything Nanotechnology is a good example of it. So size reduction technique is more beneficial in array application where a large number of elements are to be accommodated in a compact configuration. Because of that we wanted to decrease the space taken up by an array antenna. The main reason which reinforces us to do this project was to be able to design a compact array antenna. It will help us design small but efficient portable devices in wireless communication.

We have basically focused on microstrip patch antenna. This is because in the last three decades microstrip antennas have earned the most attention in RF communication system [1]. Its lightweight, low volume, low profile planar configurations and low fabrication cost make microstrip that much popular. Besides we studied the course of RF and Microwave, it made us curious to work on this microstrip patch antenna.

1.2. Literature Review

Today's world is totally dependent on communication. Antenna is a very vital part of the communication system in order to transmit and receive signal. In recent time microstrip antenna is mostly investigated antenna due to its light weight, thin, inexpensive, and the possibility of integrating the feed network into the antenna design [2]. As microstrip array antenna design is a familiar research area, lots of information was available to us. We have learnt about microstrip and array antenna design from many books, journals, article, handbooks, research papers etc.

There are several books describing antenna fundamentals among which [3] and [4] are very effective for us. In fact the book [3] helps us mostly to develop our basic on all about antenna. There are some other handbooks [5] and [6], despite being rather old, these books cover many aspects of microstrip array design.

Some good review articles from which we have added information in our paper are [1], [7], [8] and [9]. Among which first paper is written by H. Matzner, G. Sasson, M. Yacobi , and M. Haridim are most recent published article and talks about more advanced things on compact microstrip array design. Second one is written by G. Breed where he basically talks about structure and feed of a Microstrip patch antenna. The author of the third article is R.W. Dearnley, and was very effective for us on behalf of transmission line modeling. M.C. Horton and R.J Wenzel in their article describe quarterwave designing technique which helps us mostly to design an appropriate quarterwave which is able to eliminate mismatch in our array design. Article written by J. Lagerqvist [2] gave us a smart and proper direction to prepare our undergrad final project report.

There is an article which we didn't use in our paper directly but helps us to build our basic [10]. This paper is written by V. R. Gupta, S. Kumar, and N. Gupta [10] and is being a very helpful paper for us in designing an array antenna. At the same time we found the suggestion of using quarter wave transformer between two antennas in array in this paper.



1.3. Thesis Review

The first part of the second chapter introduces an antenna system. In second part it contains antenna types and their uses also. Third part basically talks about microstrip patch antenna, line feed and familiar applications of microstrip patch antenna. And the last part of the second chapter represents antenna arrays and its advantages.

Chapter three is the analysis of the antenna. Here we try to give a brief idea about antenna parameters like resonant frequency, return loss etc. We also represent two basic antenna modeling types which are transmission line model and cavity model and necessary mode require modeling the antenna in chapter three.

Chapter four is the most important part which describes design of a microstrip antenna array, discussing aspects like chooses of antenna parameters and resonant frequency; find out the optimum feed position, elimination of the impedance mismatch. In the same chapter we talk about design of quarterwave and different configuration of quarterwave like folded, round and mitered turns quarterwave. We also tried to move our project to a new direction by changing the length of the quarterwave, varying number of antennas in the array and represent all these in this chapter.

Simulation and results are exists at chapter five. In this chapter we basically show different configuration of antenna placement. We studied different simulation results for both small (1x2) and large (2x2 and 2x4) number of arrays. In addition we also studied cases where length of the quarterwave is modified (both increases and decreases). We also try to find out the best quarterwave configuration (round turns or mitered).

Finally we conclude by offering some future work in chapter six.

2. BACKGROUND THEORY

2.1. Antenna System

An antenna system consists of all the components used between the transmitter or receiver and the actual radiator. Antenna proper, transmission line, matching transformers, baluns, and filters qualify is parts of an antenna system [11].

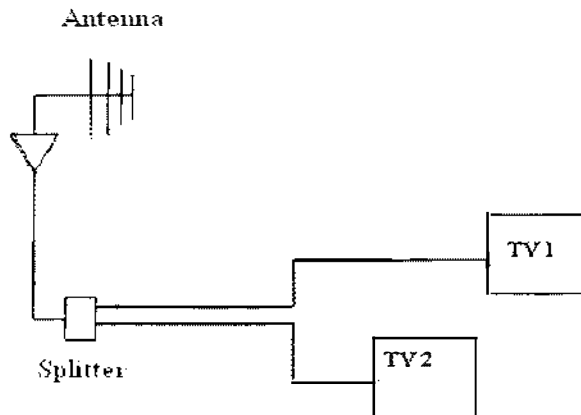

Figure 1: Antenna system

2.2. Different antennas

2.2.1. Categorization of antennas

Different types of antennas are introducing based on the shapes, sizes, working capability, demands etc. Some common and mostly used antennas are Wire antennas, Aperture antennas, Microstrip antennas, Array antennas, Reflector antennas, Lens antennas etc [3].

Wire antennas are familiar because of its use on automobiles, buildings, ships, aircrafts, spacecraft etc [3]. This type of antennas has various shapes such as straight wire which is also called dipole, loop, helix etc. Only circular shape antennas are not call loop antenna, rectangular, square, ellipse and various shapes are also member of loop antenna family. Popularity of aperture antennas is increasing now-a-days because of its sophisticated forms and utilization of higher frequencies. This type of antenna is very useful in aircraft and spacecraft applications because they can be suitably flush-mounted on the skin of the aircraft or spacecraft and in hazardous condition they are converted to a dielectric material which protects the aircraft or spacecraft [3].

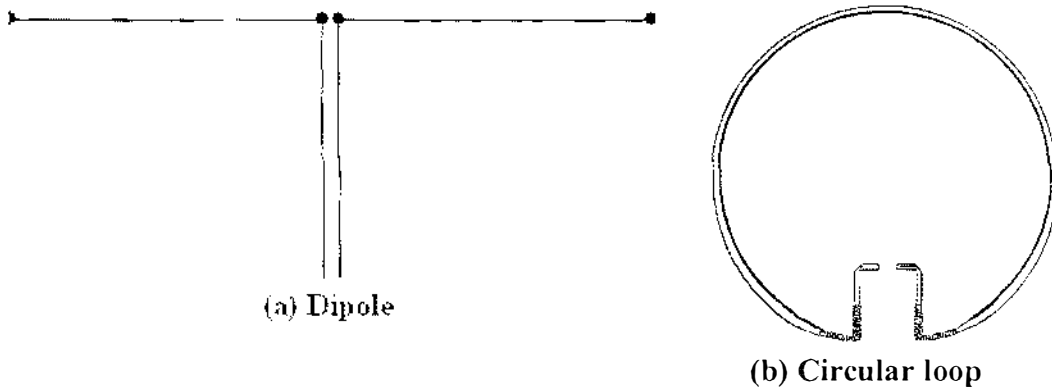

Figure 2: Wire Antenna configuration

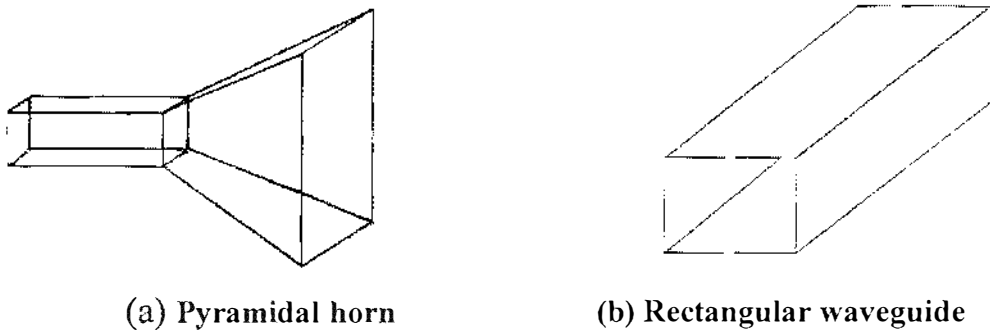

Figure 3: Aperture antenna configuration

Today microstrip antennas have huge government and commercial applications. This type of antennas consist a metallic patch on a grounded substrate. Metallic patch has different configuration like rectangular, circular. These antennas are widely used in aircraft, spacecraft, satellites, missiles, cars, mobile telephones etc [3].

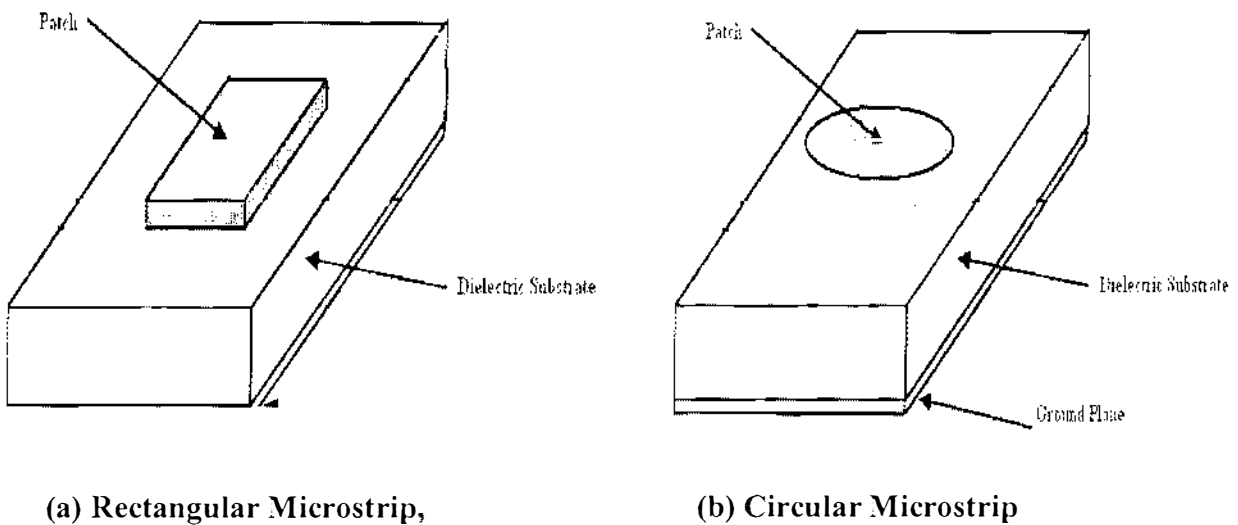

Figure 4: Microstrip antennas

Undergraduate Thesis

Arrangement of arrays is such that radiation from one element in a particular direction maximize while radiation in all other directions minimize. In arrays individual radiators are separated. So use of Array antennas are increasing to get desired radiation characteristics

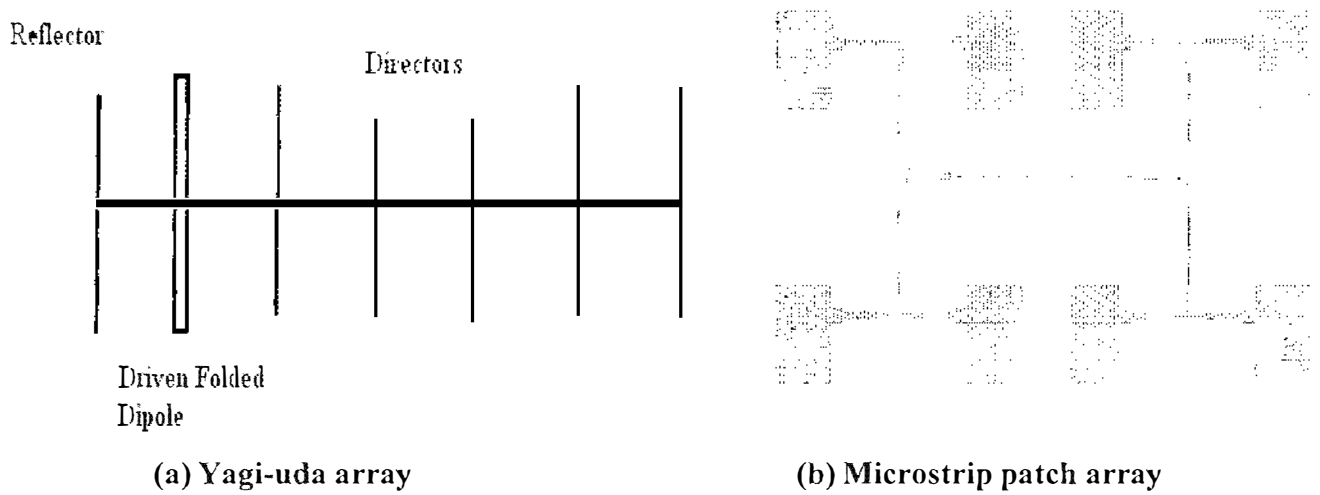

Figure 5: Array antennas

Reflector antennas are refined type of antennas which are used when transmit and receive signals have to travel millions of miles. A very common reflector antenna is parabolic antenna. This type of antennas has large diameters in meter scale. This large diameters is helpful to achieve high gain required to transmit and receive signals after million of miles of travel.

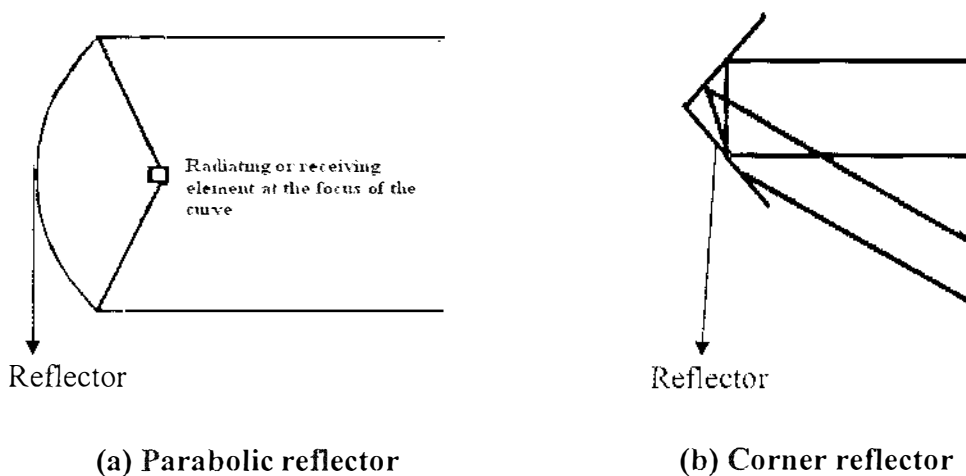

Figure 6: Reflector antennas

Lens antennas basically prevent radiation in undesirable directions. This has almost as the same application as reflector antennas but it works at higher frequencies. Lens antennas are classified according to their construction material or to their geometrical shape.

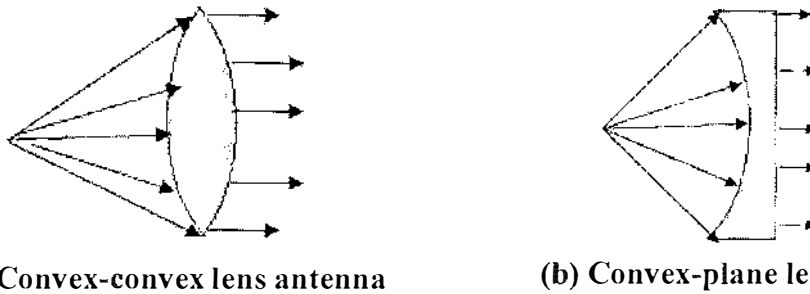

Figure 7: Lens antenna configuration

2.3. Microstrip Patch Antenna

Microstrip patch antenna consists of a radiating patch on one side of a dielectric substrate with a continuous metal layer bonded to the opposite side of the substrate which forms a ground plane [4]. The patch is generally of conducting material such as copper or gold and can take any possible shape. A patch antenna is a narrowband, wide-beam antenna fabricated by photo etching the antenna element pattern in metal trace on the dielectric substrate [7].

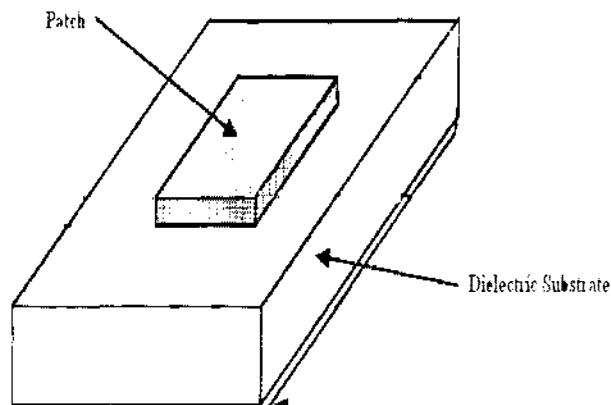

Figure 8: Microstrip Patch Antenna

Microstrip antennas are also relatively inexpensive to manufacture and design because of the simple 2-dimensional physical geometry. Patch is generally square, rectangular, circular, triangular, and elliptical or some other common shape. The most commonly employed microstrip antenna is a rectangular patch. The rectangular patch antenna is approximately one-half wavelength long section of rectangular microstrip transmission line [12].

Undergraduate Thesis

Length of the patch is usually $0.3\lambda < L < 0.5\lambda$ where λ = free space wavelength. The conductive patch is selected to be thin such that $t \ll \lambda$ where t is the patch thickness. Height of the dielectric substrate is usually $0.003 \lambda < h < 0.05 \lambda$. The dielectric constant is typically $2.2 < \epsilon_r < 12$.

Microstrip Line Feed:

A conducting strip is directly connected to the edge of the microstrip patch as shown in the figure, the conducting strip is smaller in width as compared to the patch and this kind of feed arrangement has the advantage that the feed can be etched on the same substrate to provide a planar structure. The main objective of this inset cut in the patch is to match the impedance of the feed line to the patch without the need of any additional matching element.

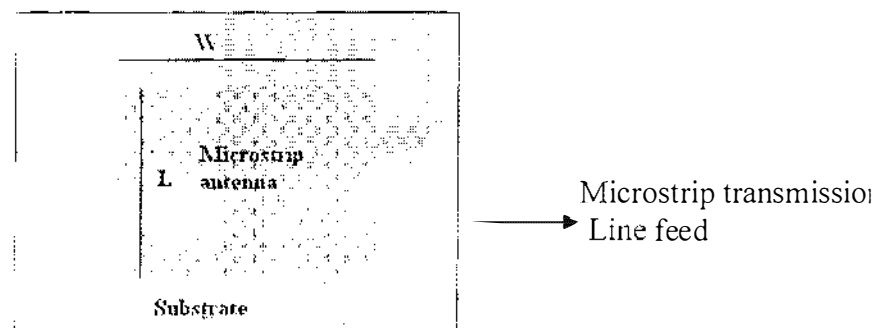

Figure 9: Microstrip Path Antenna

2.3.1. Application of patch antenna

Below table summarize the typical application of microstrip antenna. The wide range of application from transportation, communication to biomedical is summarize below in table

Table 1: Application of Microstrip Antenna

| System | Application |
|--------------------------------|---|
| Aircraft and ship antennas[13] | Communication and navigation, altimeters, blind landing systems |
| Missiles[13] | Radar, proximity fuels and telemetry |
| Satellite communications[14] | Domestic direct broadcast TV, vehicle-based antennas, communication |
| Mobile radio[15] | Pagers and hand phones, man pack systems, mobile vehicles |
| Remote sensing[16] | Large, lightweight apertures |
| Biomedical[17] | Applicators in microwave hyperthermia |

2.4 Antenna arrays

2.4.1 Uses of antenna arrays

Uses of antenna arrays are very effective in many ways[4]. First of all, it increases the overall gain of the antenna. Moreover using arrays provide diversity reception. If we can guide the array, it is most sensitive in a particular direction so use of arrays cancel out interference from a particular set of directions. Besides Array help to determine the direction of arrival of the incoming signals. Furthermore use of array rather than using a single patch can maximize the Signal to Interference Plus Noise Ratio (SINR).

Gain: using arrays increase the overall gain of the system. In our work we got better result while

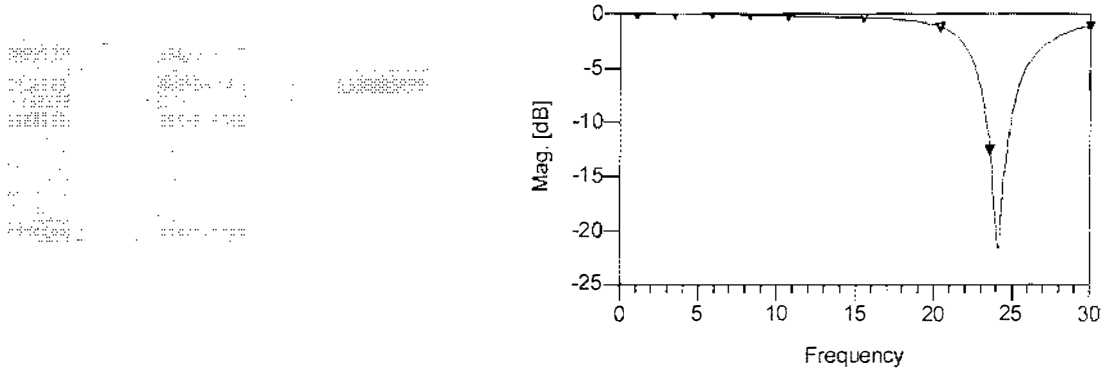

we used microstrip patch array antenna rather than using a single patch.

Figure 10: (a) Single patch, (b) Return loss versus frequency curve for single patch antenna

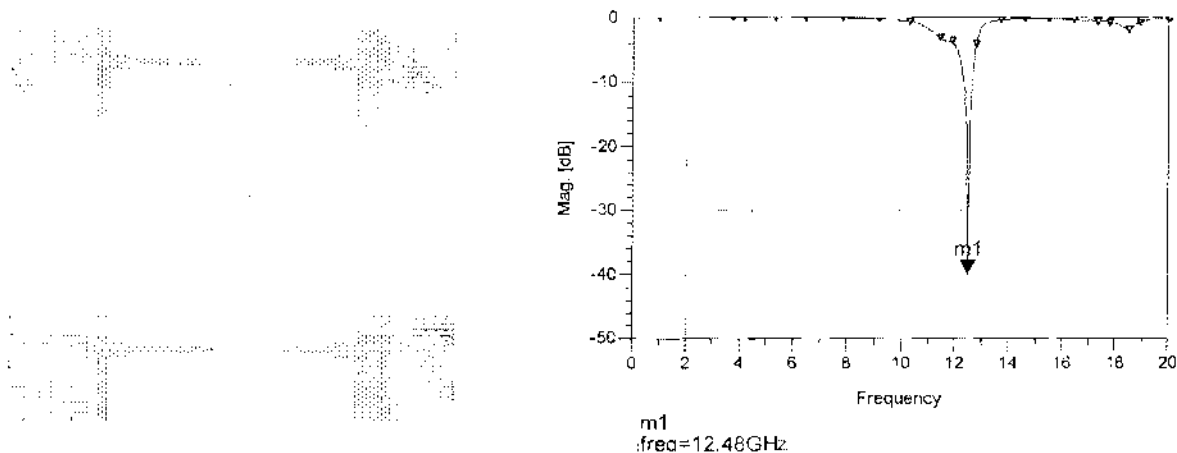

Figure 11: (a) Patch array, (b) Return loss versus frequency curve for patch array antenna

Undergraduate Thesis

Comparing above results we can say that return loss minimize while we use array antenna and as we know minimization of loss means increase of gain. So it we can say uses of array increase the gain of the system.

Diversity reception: Received signal's power varies significantly with small changes in distance.

A diversity array uses a set of antennas and combines signals to obtain the maximum signal [4].

Interference cancellation: Arrangement of arrays is such that radiation from one element in a particular direction maximize while radiation in all other directions minimize. So use of arrays cancels out interference from a particular set of directions.

Determination of direction of the upcoming signal: The adaptive antenna can be steered to the last known best direction for reception of a particular detected signal. Detection of incoming signal helps in interference cancellation so that signal quality improves.

Maximization of the Signal to Interference plus Noise Ratio (SINR): As we know use of array causes interference cancellation which improve signal to interference noise ratio.

3 ANTENNA ANALYSIS

3.1 Critical antenna parameters

Resonant frequencies:

Resonance is the tendency of a system to oscillate at larger amplitude at some frequencies than at others. These frequencies are referred as resonant frequencies [18]. In an Electrical Circuit when the impedance between the input and output of the circuit is at a minimum then the resonance occurs. This generally happens when the impedance between input and output is almost zero.

In the figure below the impedance is minimum at the frequency of 24 GHz. The input and output impedance is set to minimum at that frequency. In this frequency the antenna can be operated.

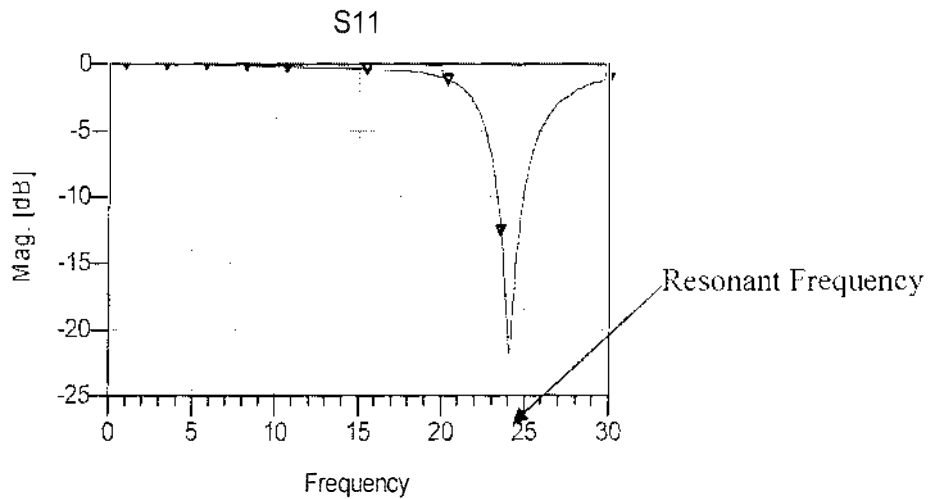

Figure 12: Resonant frequency

Resonance frequency of a system in TM mode can be calculated using this equation,

$$(f_{rc})_{010} = \frac{1}{2L_{eff} \sqrt{\epsilon_{reff}} \sqrt{\mu_o} \epsilon_o} \dots\dots\dots (1)$$

Where,

L_{eff} = Effective length, ϵ_{reff} = Effective Dielectric Constant, and f_{rc} = Resonant Frequency

Radiated power

Effective radiated power or equivalent radiated power (ERP) is a standardized theoretical measurement of radio frequency (RF) having SI unit watts [19]. We get effective radiated power by subtracting system losses and adding system gains. In ERP calculation transmitter power output (TPO), transmission line attenuation (electrical resistance and RF radiation), RF connector insertion losses, and antenna directivity is considered. ERP is typically applied to antenna systems.

For a example, if an antenna system has 9 dB gain and 6 dB loss, its ERP is 3 dB.

If full-wavelength spacing is used between antenna elements in an array, the ERP is increased multiplicatively with the number of elements.

$$\text{So, ERP (Watt)} = \text{Gain-Loss}$$

Return loss

The return loss (RL) is a parameter which indicates the amount of power that is lost to the load and does not return as a reflection. As we know, waves are reflected leading to the formation of standing waves, when the transmitter and antenna impedance do not match. Hence the RL is a parameter similar to the VSWR to indicate how well the matching between the transmitter and the antenna has taken place. The RL is defined as $RL = 20 \log_{10} \Gamma$.

For perfect matching between the transmitter and the antenna, $\Gamma = 0$ and $RL = \infty$, which means no power is reflected back, while $\Gamma = 1$ has an $RL = 0$, which implies that all the incident power is reflected. In practical application, a VSWR of 2 is acceptable corresponds to an RL of -9.5 dB or 11% power reflection [20].

3.2 Antenna modeling

Antenna modeling can be done in two ways. One is transmission line model and another is cavity model. In our experiment we used transmission line model. Transmission line model represents the microstrip antenna by two slots, separated by a low-impedance transmission line of length L.

3.2.1 Transmission-Line Model

We used lumped-element model of a transmission line to calculate characteristic impedance. A lumped transmission line model with series resistance, series inductance, shunt conductance and shunt capacitance are all normalized per unit length is shown below [8].

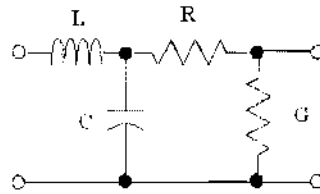

Figure 13: Lumped lossy transmission line model

The general expression of the characteristic impedance is:

$$Z_0 = \sqrt{Z/Y}$$

We considered a low-loss transmission line, the following relationships will occur:

$$G \ll j\omega C \text{ \& } R \ll j\omega L$$

Then the transmission lines characteristic impedance equation reduces to:

$$Z_0 = \sqrt{L/C}$$

Then we had to calculate the impedance of the line. This was calculated using the Equation below-

$$Z_T = \sqrt{(Z_{in} * Z_0)}$$

Where Z_T is the impedance of the line (acting as a quarterwave transformer), Z_{in} is the impedance looking in to it, and Z_0 is the system impedance which terminated both ends of the line.

3.2.1.1 Fringing Effects

We must consider this special characteristic of the transmission line model because it influences the resonant frequency of the antenna. Though the dimensions of the patch are finite along the length and width; the fields at the edges of the patch undergo fringing. This shown in below:

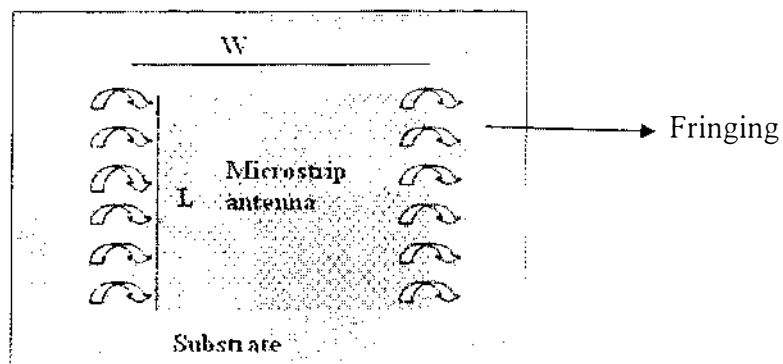

Figure 14: Fringing

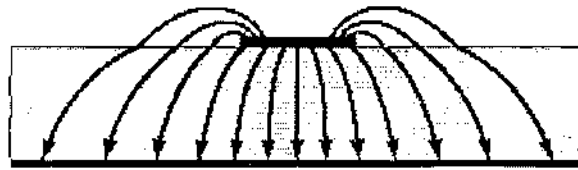

Figure 15: Electric field lines

In fringing electric field lines reside in the substrate and parts of some lines exist in air. This is called non homogeneous line of two dielectrics. Typically the dielectrics are substrate and air. Due to fringing, the microstrip line looks wider electrically compared to its physical dimension. Typically the effective dielectric constant has values in the range of. For most applications where the dielectric constant of the substrate is much greater than unity ($\epsilon_r \gg 1$), the value of ϵ_{eff} will be closer to the value of the actual dielectric constant of the substrate. Though the effective dielectric constant is also a function of frequency, as the frequency of operation increases, most of the electric field lines concentrate in the substrate. Therefore microstrip line behaves more like a homogeneous line and the effective dielectric constant approaches the value of the dielectric constant of the substrate.

3.2.2 Cavity Model

Microstrip antenna looks like cavity full with dielectric. By considering cavity model normalized fields within the substrate (between the patch and the ground plane) can be found more accurately. This model exhibits reactive input impedance and zero radiated power so this quantity can be compare well with measurements. To understand the cavity model one should understand the formation of the fields within the cavity and the radiation through its side walls first. When microstrip is energized, charge distribution is established on the upper and lower half of the surface which is shown in the figure below-

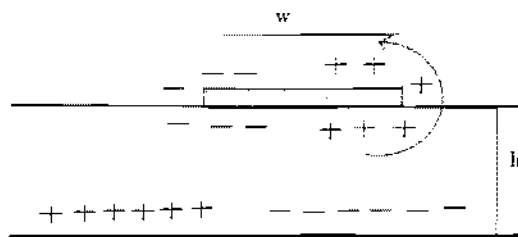

Figure 16: Charge distribution and current density creation on Microstrip antenna

Undergraduate Thesis

Charge distribution in a cavity model is controlled by two mechanisms, attractive and repulsive mechanism. The attractive mechanism is between the corresponding opposite charges on the bottom side of the patch and the ground plane which tends to maintain the charge concentration on the bottom of the patch. The repulsive mechanism is between like charges on the bottom surface of the patch which tends to push some charges from the bottom of the path around its edges to its top surface. The movement of this charge creates current. Since for most practical micro strips the height-to-width ratio is very small, the attractive mechanism dominates and most of the charge concentration and current flow remain underneath the patch. A small amount of current flows around the edges of the patch to its top surface. This current flow decreases as the height-to width ratio decreases. If the current flow to the top is zero, which is ideal and not create any tangential magnetic field components to the edges of the patch. This allows the four side walls to be modeled as perfect magnetic conducting surfaces which do not disturb the magnetic field and also the electric field distributions below the patch. Since in practice there is a finite height-to-width ratio, although small, the tangential magnetic field at the edges would not be exactly zero. However, since they will be small, a good approximation to the cavity model is to treat the side walls as perfectly magnetic conducting. This model produces good normalized electric and magnetic field distributions (modes) beneath the patch.

3.2.3 TM mode

Transversal Magnetic Mode

In the transversal magnetic modes or TM modes means that only three field components are considered. The three fields are electric field in the z direction that is perpendicular to the ground plane and x-y direction that are parallel to the ground plane. In general the modes are designated as TM_{xyz} . The z is mostly omitted since the electric field variation is considered negligible in the z-axis. Hence TM_{xy} remains with x and y the field variation in x and y direction. The field variation in the y direction (impedance width direction) is negligible, thus y is 0. Lastly the field has one minimum-to-maximum variation in the x direction (resonance length direction), thus x is in a fundamental case. Hence the notation is TM_{10} [3].

4 FOLDED ANTENNA ARRAY FEED

4.1 Microstrip Patch Antenna Arrays for 12.8 GHz

Antenna designed by Gonaca Gakir and Levent Sevagi has been used here as a reference [21].

Antenna Parameters: Length of the Antenna is $L = 4.01$ mm, Width of the Antenna is $W = 3.55$ mm, Width of the feed = 0.47 mm, position of the width from the top = 0.89 mm. In the Layout of ADS we used the Momentum Menu to design the Patch.

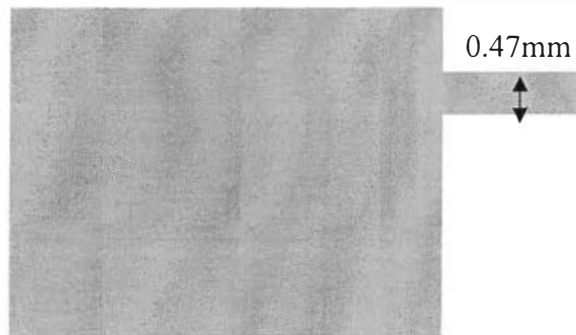

Figure 17: Microstrip patch antenna

4.2 Elimination of the Impedance Mismatch

The Resonant frequency was observed to 24 GHz. Due to mismatch in the impedance between the Feed line and the patch, the Feed width was redesigned to get the better resonant frequency and remove the impedance mismatch. So we calculated the width of the feed to be 0.5 mm using LineCalc. The design of the patch is of 50 ohm so we chose the width 0.5 mm for feed line and got the same impedance of 50 ohm. Then we simulated the design and found that the resonant frequency was about 12.8 GHz and the return loss of 15 dB.

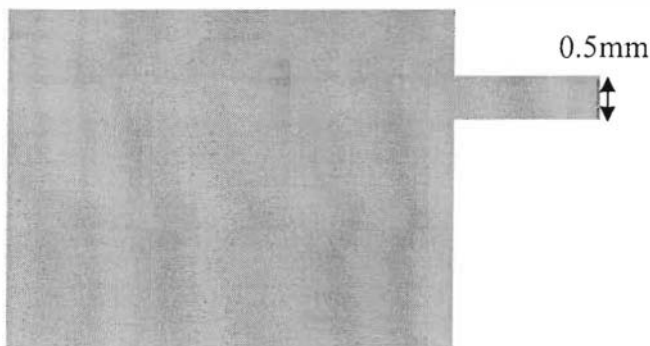

Figure 18: Microstrip patch antenna with new feed line width

4.3 The Optimum Feed position

The return loss was not as expected, only -15 dB. To have large return loss we changed the position of the feed line along the edge of the patch. From the Table we see the results. [22]

Table 2: Feed position optimization

| Observation | Feed Position (mm) | Return loss (dB) | Resonant frequency (GHz) |
|-------------|--------------------|------------------|--------------------------|
| 01. | 0.72 | -13.77 | 12.75 |
| 02. | 0.81 | -19.441 | 12.78 |
| 03. | 0.85 | -24.19 | 12.81 |
| 04. | 0.87 | -30.408 | 12.80 |
| 05. | 0.89 | -53.51 | 12.81 |
| 06. | 0.90 | -36.97 | 12.81 |
| 07. | 0.91 | -31.074 | 12.81 |
| 08. | 0.92 | -27.16 | 12.81 |
| 09. | 1.0 | -15.21 | 12.84 |

From the Table we see that when we set the Feed line at 0.89 mm from the top then we found the minimum return loss. The minimum return loss is -53.51 dB.

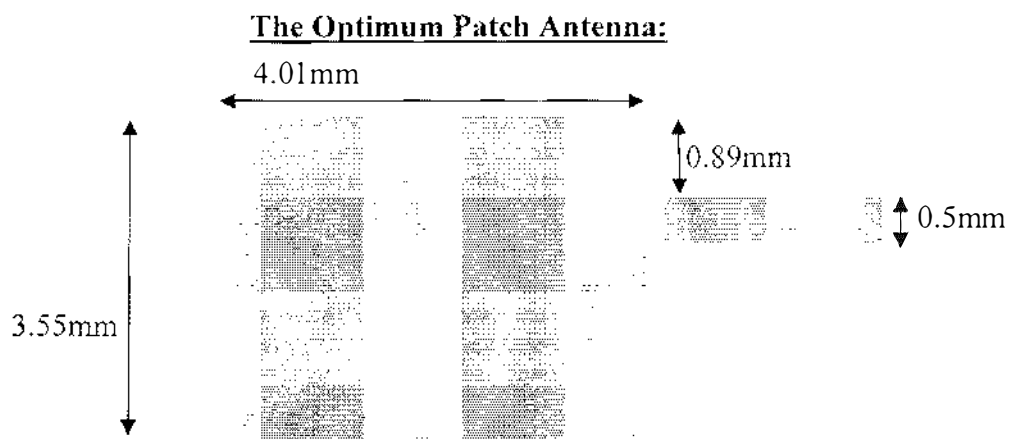

Figure 19: Microstrip patch antenna having optimum feed position

4.4 Different Configuration of Feed line

4.4.1 Symmetric width of the feed line

4.4.1.1 *Array Design: 1 x 2*

In this Array antenna we have kept the width of all the feed lines symmetric, i.e. same. There will however be impedance mismatch at the Y junction of the feed lines. The impedance of the

primary feed will be double that of the parallel combination of the two antenna feeds. Due to the mismatch there will be a distortion in the resonance frequency. S-parameter simulation will help us analyzing those results.

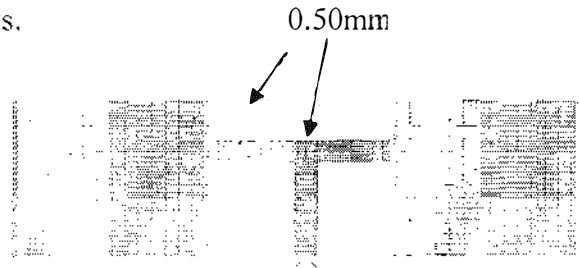

Figure 20: 1x2 Microstrip array antenna with symmetric feed line

4.4.1.2 Array Design: 2×2

In the picture below we have connected four antennas in array, as we connect more antennas then the parallel feed line arrangement needs to be calculated again. But the feed line width is kept symmetric then we will have more impedance mismatch in the feed line width, so there will be more distortion in the S-parameter.

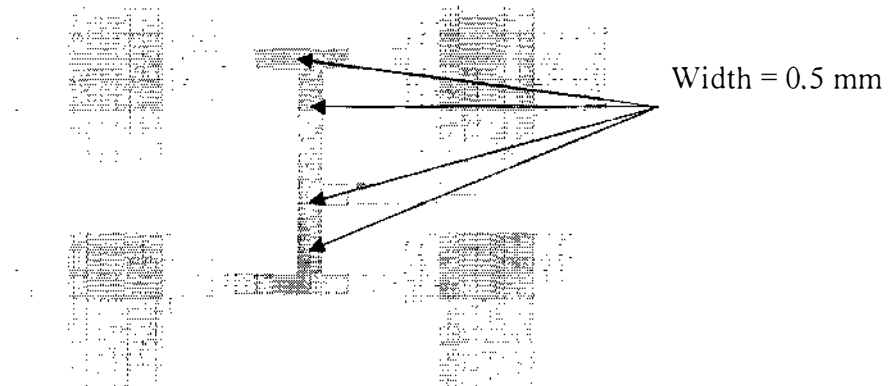

Figure 21: 2x2 Microstrip array antennas with symmetric line feed

4.4.2 Impedance matching varying the feed line width

We can proceed in our design part by varying the width of the feed line in an Array design. We have used the LinCalc option of the ADS to calculate the width of the feed for given parameters.

4.4.2.1 Array Design: 1×2

Using the LineCalc we have calculated the width of the parallel feed line is 1.62mm for 1 x 2 array antenna to match the impedance of 50ohm system.

Impedance Matched using LineCalc:

When we split the feed line then the width needs to be in a way where the Impedance has to be matched. In our design the Impedance mismatch is removed by using the LineCalc option as we have taken the calculated width but the width of the feed was calculated 1.62 mm which can cause another problem.

The width of the Antenna is itself 3.86mm so if the feed line width is 1.62 mm then the feed line can itself behave like an Antenna then we will have another resonance frequency which is not desired.

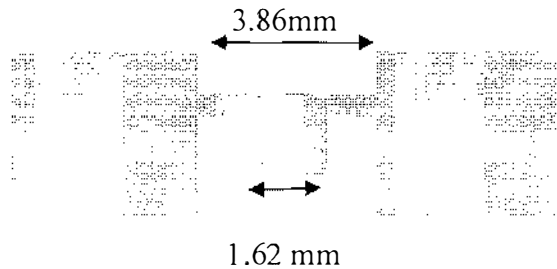

Figure 22: 1x 2 Microstrip patch antenna using splitting transmission line feed

4.4.2.2 Array Design: 2 x 2

Now we have designed 2 x 2 array antenna using the same splitting feed line method in order to match the Impedance by varying the width of feed line. As we split the feed line to match the impedance the width of the feed line increases the parallel feed line width increased to 4.029 mm which is greater than the width of Antenna itself. So we can assume that the S-parameter will be more distorted, the feed lines will work as antenna and we will have more resonant frequencies. The width of the Antenna is itself 3.86mm so if the feed line width is 1.62 mm then the feed line can itself behave like an Antenna then we will have another undesired resonance frequency.

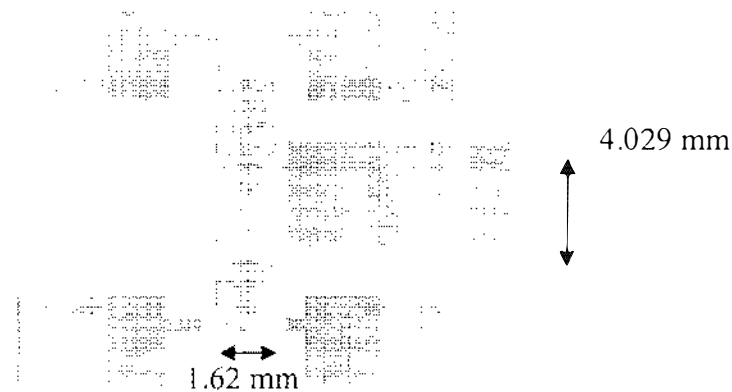

Figure 23: 2x 2 Microstrip array antennas using spilling transmission line feed

4.5 Quarter wave Design

Use of Quarterwave is renowned to remove impedance mismatch between the load and the transmission line. We got various articles written on it among which paper written by Horton, M.C. Wenzel and R.J [9] helped us mostly.

The input impedance of the patch Antenna is 50 ohm. And the Load impedance we set to 100 ohm. The width we calculated using LineCalc is 0.06 mm

Quarter wave impedance $Z_0 = \sqrt{Z_{in} \times Z_L} = \sqrt{50 \times 100} = 70.71 \text{ ohm}$

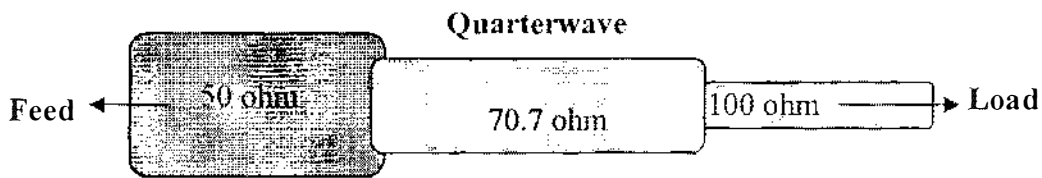

Figure 24: Quarterwave

Using LineCalc we can design a Quarterwave which has the characteristic impedance 70.71 ohm. Using LineCalc we find the width is 0.21 mm and the length is 3.005 mm, but we added some mismatch to get the best S-parameter results so we assumed the length to be 2.90 mm.



Figure 25: Quarterwave we designed

Figure 26: LineCalc option of ADS to find the characteristic impedance of the quarterwave

4.5.1 Design of an 1 x 2 array using quarterwave

In this design we have used Quarter wave transformer, Quarter wave have eased our design, the characteristic impedance of Quarter wave was calculated 70.7 ohm so the width is reduced and the transmission line is 100 ohm so the width is more reduced so we have managed to solve the problem of excess resonance frequencies. From this design 1 x 2 array antenna we can hope for excellent S-parameter results.

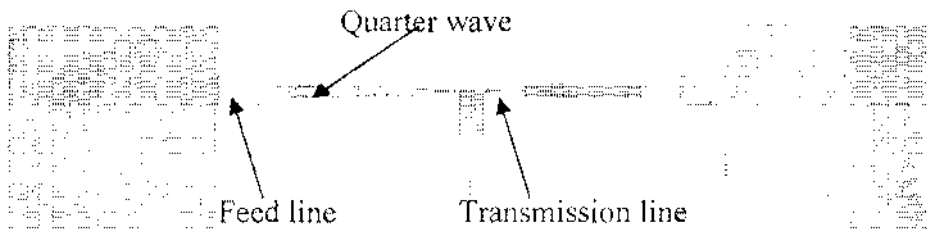

Figure 27: 1x2 patch array antenna using quarterwave

4.5.2 Design of 2 X 2 Array using quarterwave

We have designed 2 x 2 array antennas, as we proceed for 2 x 2 array designs we find that we don't need to redesign the feed lines again for larger array which eases our task. For 2 x 2 Array antenna the return loss can be reduced and the gain is higher the resonant frequency is not changed.

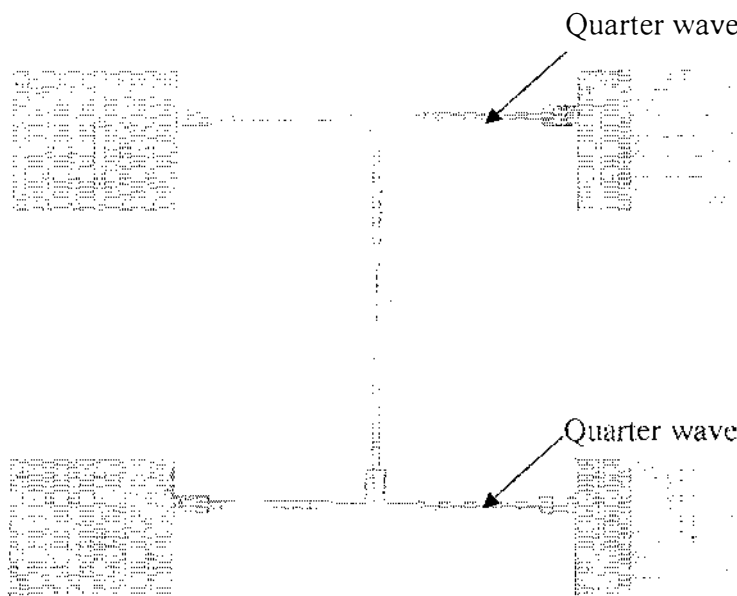

Figure 28: 2x2 patch array antenna using quarterwave

4.5.3 Array Design 2 x 4 using quarterwave

We have designed 2 x 4 array antennas in order to get better gain, in our design there can be little bit mismatch in impedance because the this is a large Array. So the return loss can improve from 2 x 2 array design.

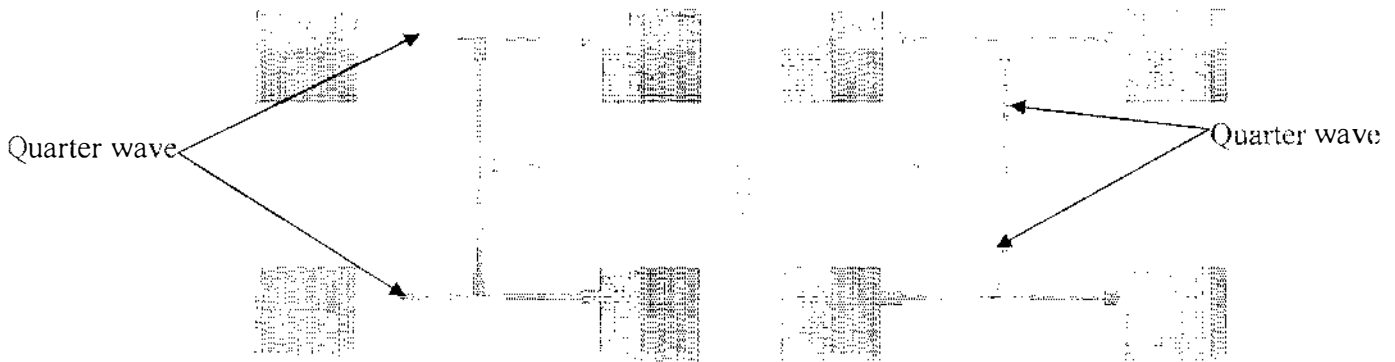

Figure 29: 2x4 patch array antenna using quarterwave

Advantages of using Quarterwave over a Symmetric feed and split matched feed:

The main reason to use quarterwave is it prevents to change the resonant frequency of the circuit. At the same time we can use the same transmission line width for increasing the number of arrays. Besides for the symmetric feed as the transmission line width is high so it starts behaving like an Antenna which results another resonant frequency. But Quarter wave eliminates those problems. Moreover low Return loss and elimination of excess resonance frequency can be achieved using quarterwave.

Constrains of Using Quarter wave in General way:

As we were using Quarter wave of 2.90 mm in our array design the length for the increasing array was increasing simultaneously. So for a limited space the design is not applicable. Moreover low Return loss and elimination of excess resonance frequency can be achieved using quarterwave.

4.6 Our Proposal

4.6.1 Folded Quarterwave in order to reduce the Length

So we proposed Folded Quarter wave which is helpful to reduce the length of the Array.

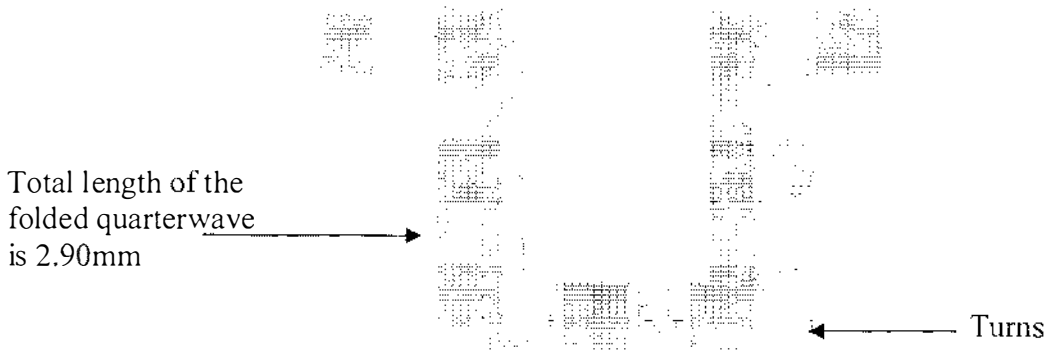

Figure 30: Folded quarterwave

From the figure above we can see that the length of the Quarter wave was reduced significantly. So this design will help to reduce the length. The length of the Quarter wave was measured by the average value of the internal and external edges. So we took the mid path to measure the length.

4.6.1.1 *Array using Folded Quarter wave: 1 × 2*

We have now applied the folded Quarterwave in our Array design. The width of the Quarter wave is not identical along the line because in the turns the width of the Quarter wave is higher than the straight lines.

So there will be an impedance mismatch at the turns. As a result we will have S-parameter distortion.

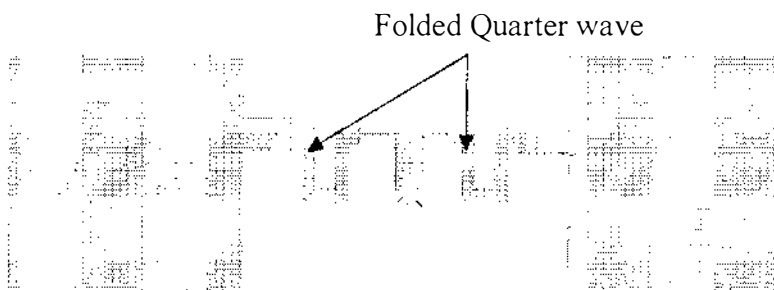

Figure 31: 1x2 patch array antenna using folded quarterwave

There can be excess resonance frequency and the return loss will be distorted as the width is not constant along the lines.

4.6.1.2 *Folded design: 2 x 2*

Now we have applied the folded Quarter wave in 2 x 2 array design. In this design we have used six quarter waves. So the mismatch is more along the turns so the S-parameter results will be more distorted. The return loss will reduce and there will be excess resonance frequency.

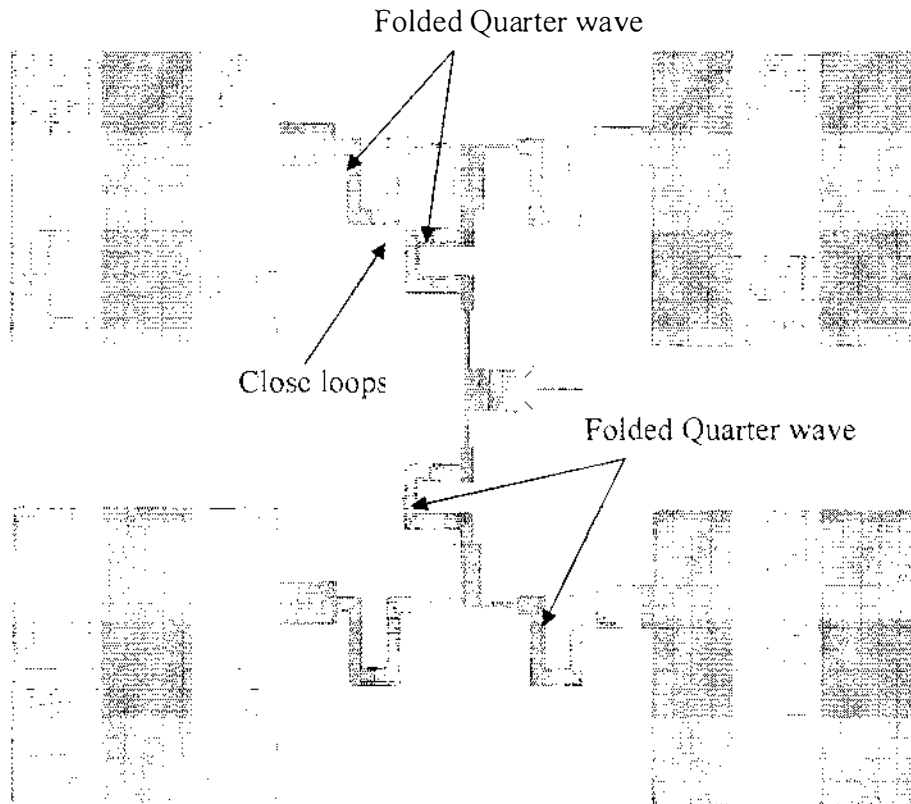

Figure 32: 2x2 patch array antenna using folded quarterwave

Because of the close Quarter wave there will be mutual capacitance so it can behave like another antenna and we may get excess resonance.



4.6.2 Curved Turns Folded Quarterwave

In the general folded Turns we had a width variation along the lines and the turns had higher width, so to remove the problem we proposed another solution, we would curve the turns of the Folded Quarter wave. Using ADS design tool we have curved the turns of the folded Quarter wave.

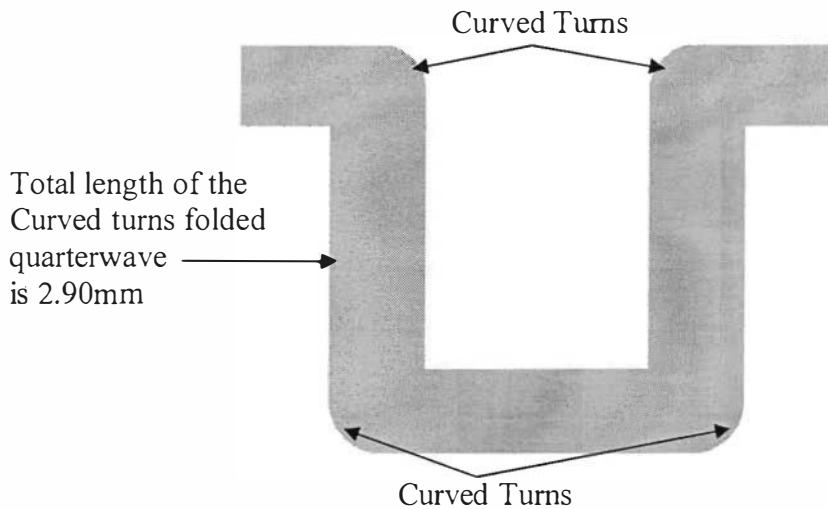

Figure 33: Curved turns folded quarterwave

The proposed idea can make the width uniform along the line and even on the turns. So then we can have low return loss. We can apply this design in the Array.

4.6.2.1 *Curved Turns Folded Quarter wave: 1 × 2*

We have applied the Curved Turns folded Quarter wave in the Array design, it will help to reduce the return loss and the resonant will be accurate because the width is matched along the line this time.

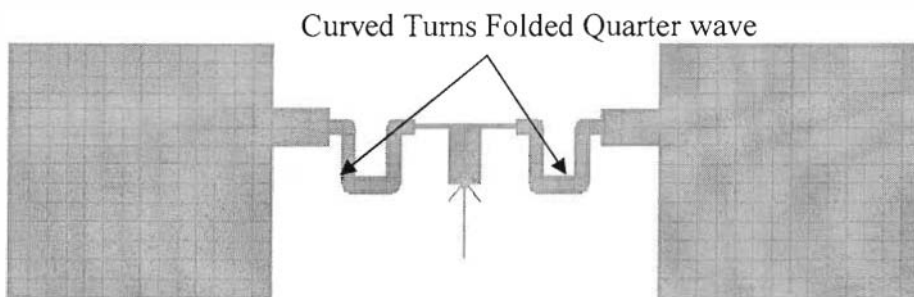

Figure 34: 1x2 patch array antenna using curved turns folded quarterwave

4.6.2.2 Curved Turns Folded Quarter wave: 2 x 2

The same design is applied in 2 x 2 array antenna to maximize the gain. As we go further into the design the mismatch will increase, it can change the resonance frequency and can affect the Return loss.

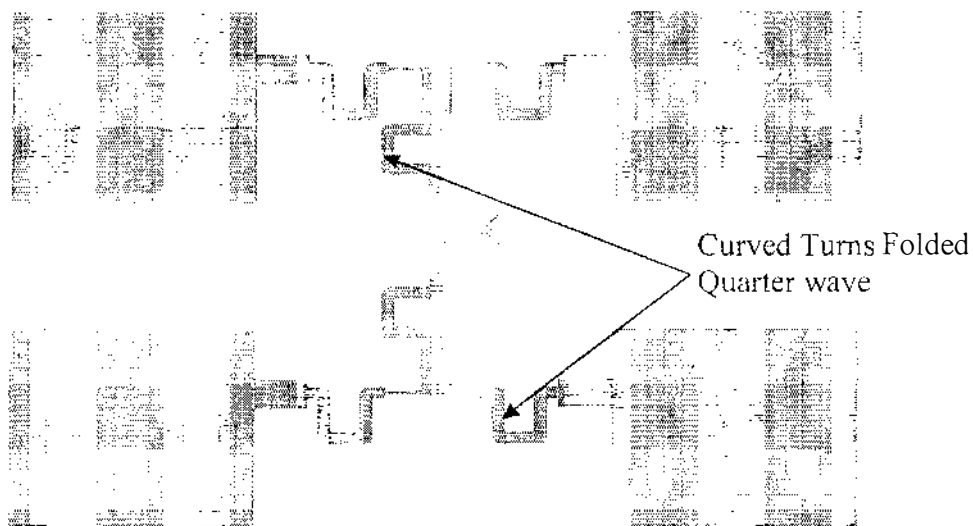

Figure 35: 2x2 patch array antenna using curved turns folded quarterwave

4.6.3 Mitered Turns Folded Quarterwave

We can use another option of ADS which is Mitered; here the turns will be mitered to match the width. A miter joint is a joint made by beveling each of two parts to be joined, usually at a 45° angle, to form a corner, usually a 90° angle.

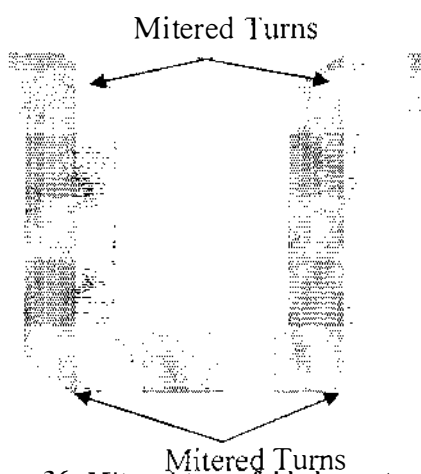

Figure 36: Mitered turns folded quarterwave

Mitered turns will help us to remove the width variation at the turns so we can expect a better result in S-parameter analysis.

4.6.3.1 Array Design: 1 x 2

We have applied the Mitered Turns folded Quarter wave in our array design. We can expect a better result because the width is aligned along the lines so there impedance mismatch will be removed. So we can have better Return loss parameters and the resonance frequency will remain same.

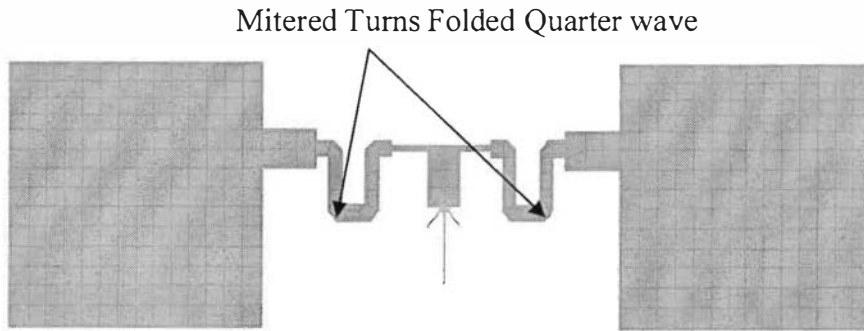

Figure 37: 1x2 patch array antenna using mitered turns folded quarterwave

4.6.3.2 Mitered Turns Quarterwave: 2 x 2

Now we have applied the Mitered turns Quarter wave in our Array of 2 x 2, this design will compact the size of the antenna and the mitered turns will make the width uniform along the lines. So we can expect better return loss and we can expect the same resonance frequency.

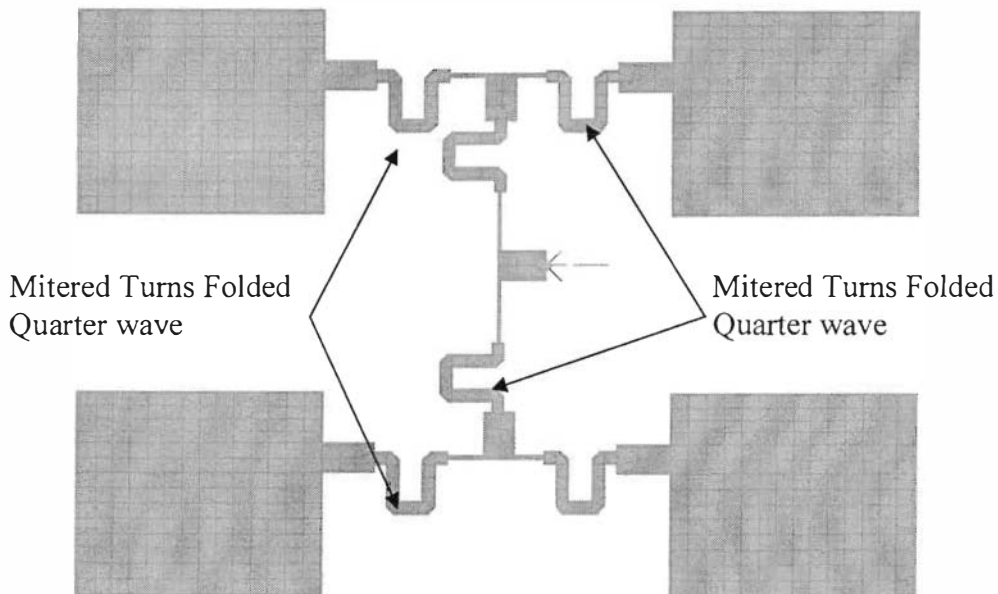

Figure 38: 2x2 patch array antenna using mitered turns folded quarterwave

4.7 Changes in Folded Quarter Wave transformer Length

4.7.1 Increment in the Length of Quarterwave by 5%

New length of the quarter wave is 3.02mm after increasing the length by 5% from 2.90mm. As we have increased the length then the mismatch of impedance may appear. We can then determine the tolerance range of the length of the folded Quarter Wave.



Figure 39: 2x2 patch array antenna using the quarterwave which has the length increases by 5%

4.7.2 Decrement in the Length of Quarter wave by 5%

We have decreased the length of the curved quarter wave by 5%. So it is now 2.76mm from 2.90mm. Result is not satisfactory. As we have decreased the length then the mismatch of impedance may appear. We can then determine the tolerance range of the length of the folded Quarter Wave

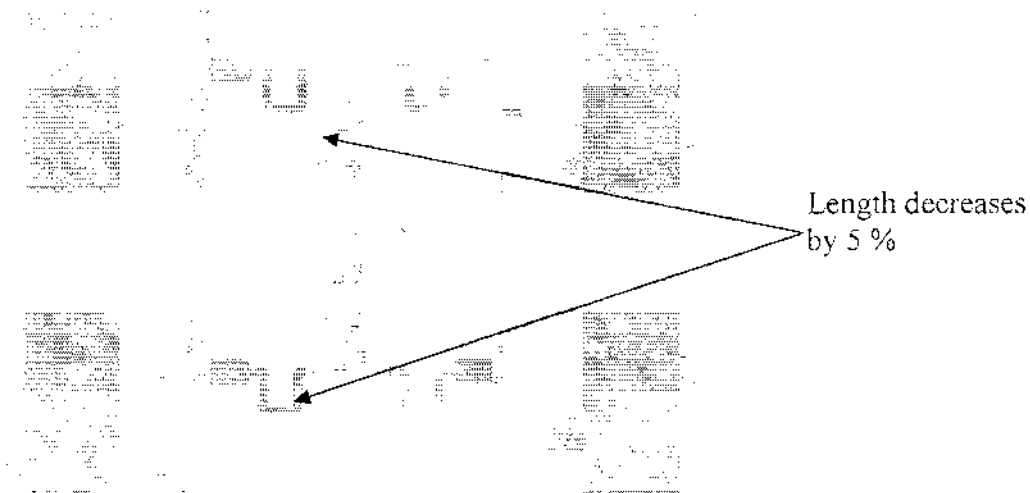

Figure 40: 2x2 patch array antenna using the quarterwave which has the length decreases by 5%

4.8 Array Antenna using folded Quarter wave: 2 x 4

Using Curved Turns Quarter wave:

As we precede in the 2 x 4 Array design we can increase the gain of the Antenna but if there is little impedance mismatch then in an array the mismatch will turn into huge. So the return loss can increase and the resonance frequency can vary.

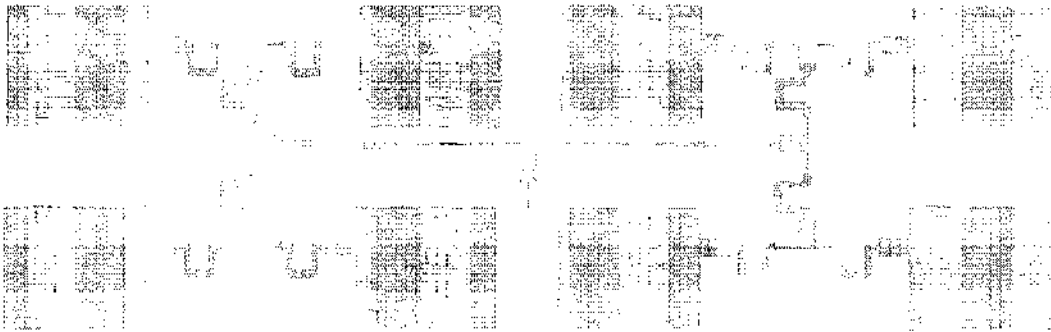

Figure 41: 2x4 array antenna using folded quarterwave

Using Mitered Turns Quarter wave:

As we precede in the 2 x 4 Array design we can increase the gain of the Antenna but if there is little impedance mismatch then in an array the mismatch will turn into huge. So the return loss can increase and the resonance frequency can vary.

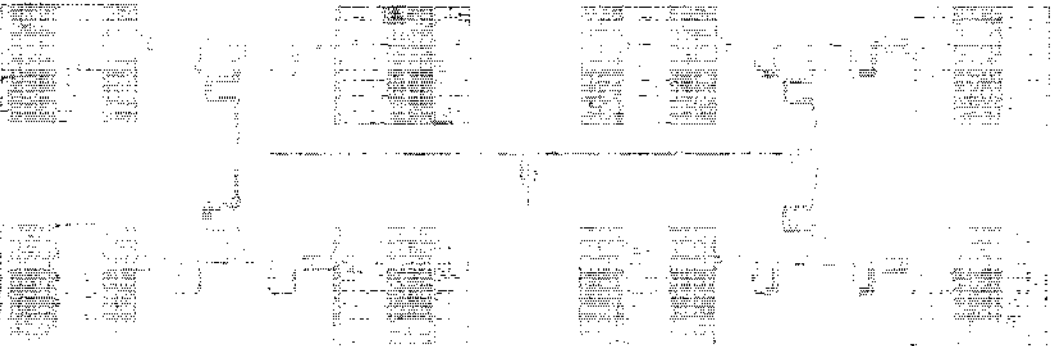

Figure 42: 2x4 array antenna using mitered turns folded quarterwave

5 SIMULATION AND RESULTS

Here, we are simulating a Patch Antenna using ADS. In the Layout window of ADS we modeled the patch and simulated using momentum. First we started with a regular patch antenna with a feed where the parameters are as following.

Length of the antenna= 4.01mm

Width of the antenna= 3.55mm

Width of the feed= 3.55mm

Feed position from the top= 0.89mm

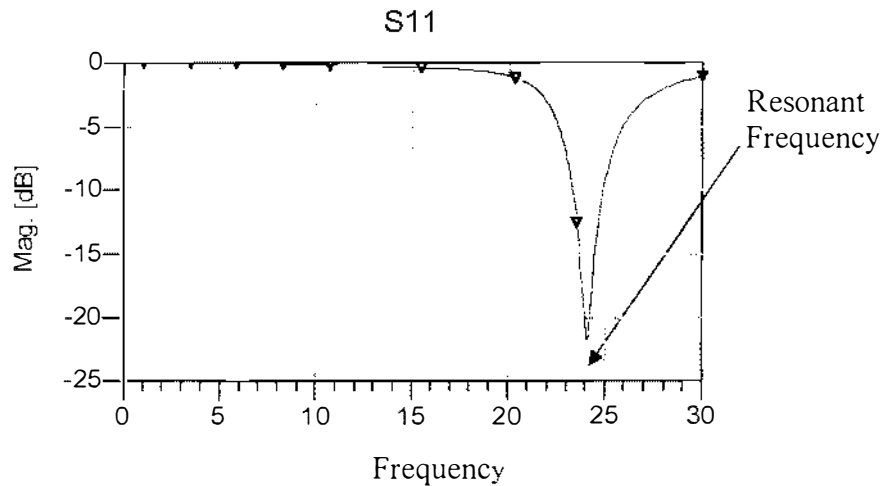

Figure 43: Return loss versus frequency curve for patch array antenna

From simulation results,

Resonant frequency= 24 GHz and, Return loss= -23dB

We can see that the resonant frequency is higher and return loss is also higher.

Then we changed the feed of the width to 0.50mm to match the 50ohm system impedance.

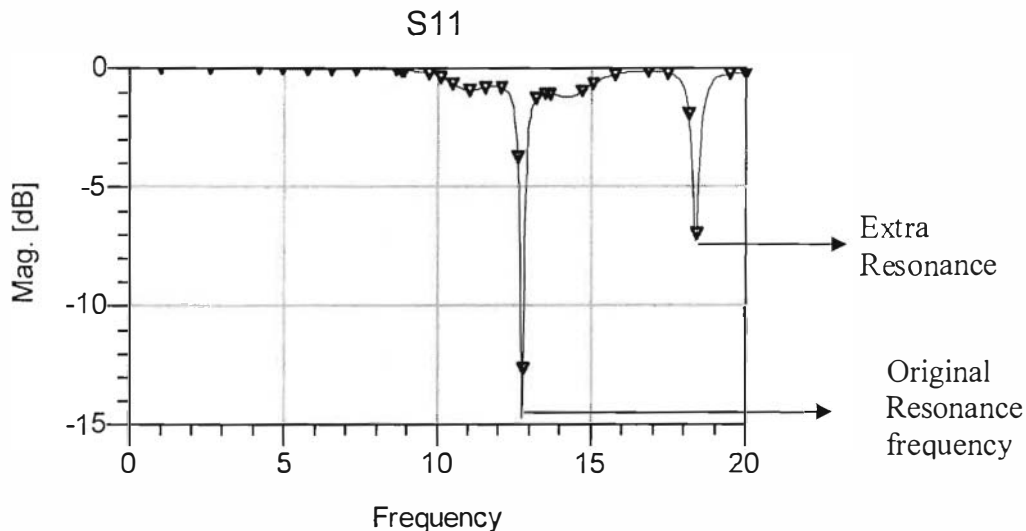

Figure 44: Return loss versus frequency curve after changing the feed width

From simulation result it is clear that feed width 0.50 mm matches the system impedance of 50 ohm which helps to reduce the resonance frequency. From the picture above the resonant frequency is 12.8 GHz. But here we observed an extra resonance frequency and higher return loss because of random feed position. We need to optimize the feed position.

5.1 Feed position optimization

For the different feed positions we have simulated the S-parameter and observing the results we will find the best feed position

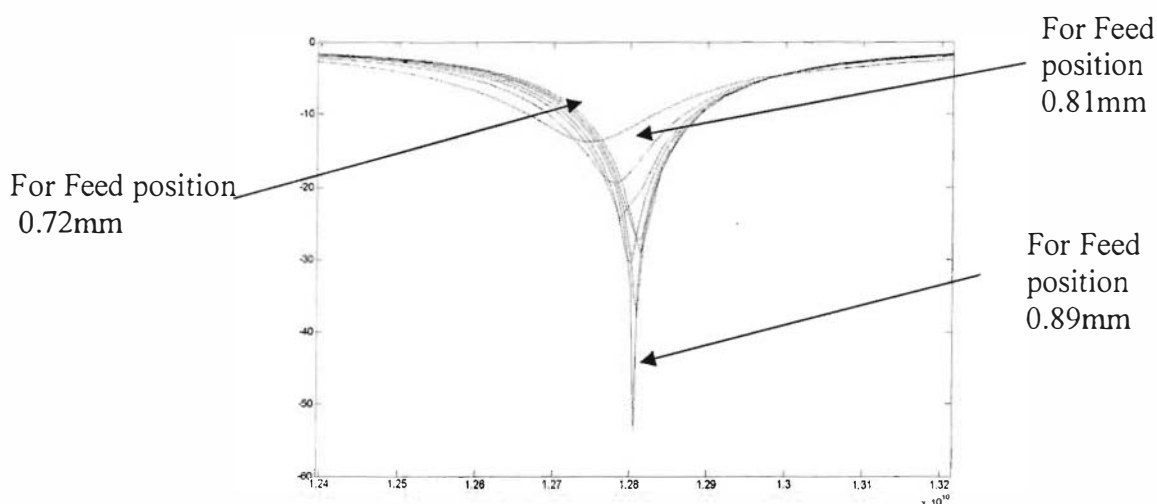
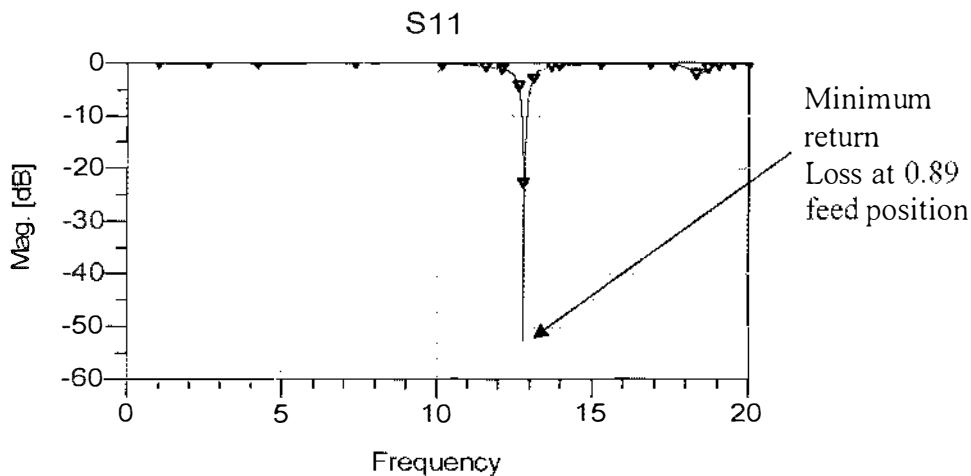

Figure 45: Group of curves for finding the optimum feed position

To optimize the feed position we changed the position of the feed line along the edge. And we observed the minimum return loss when we set the feed line at 0.89mm from the top of the patch. So we achieved the minimum return loss of -53.51dB at the resonant of 12.81 GHz. This is because with the feed line at 0.89mm, there will be minimum impedance mismatch between patch and feed.

Other observed measurements are at 0.72 mm feed position return loss was -13.77dB and for 0.89 mm feed position return loss was -15.21 dB. So we choose the optimum feed position, i.e. 0.89mm from top.

Figure 46: Simulation result for optimum feed position



5.2 Secondary resonance in 1 x 2 array antenna

In the simulation results we have observed some excess resonance, we can see in the figure the secondary resonance. So the symmetric feed increases the return loss and introduces secondary resonance.

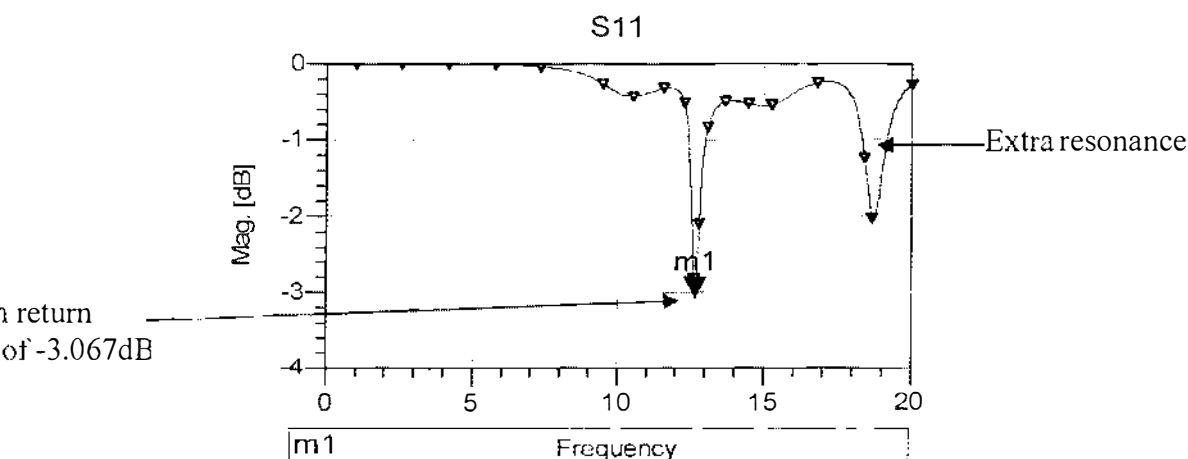

Figure 47: Simulation result of 1x2 array antenna using symmetric line feed

5.3 Secondary resonance in 2 x 2 array antenna

Simulation is for the identical feed lines of a 2 x 2 array antenna; we have simulated the antenna and found the following result.

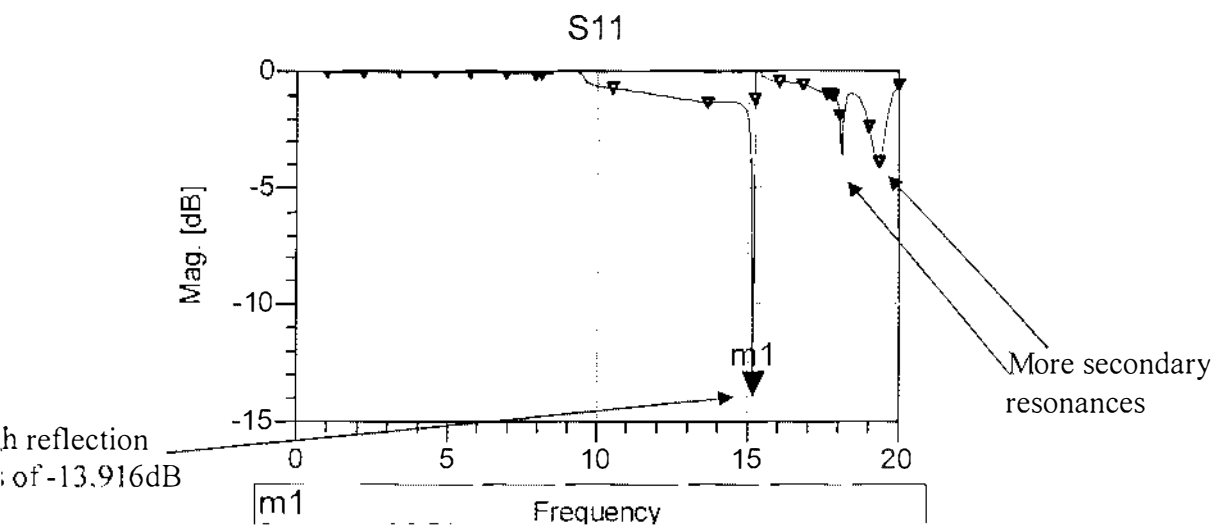

Figure 48: simulation result of 1x2 array antenna using symmetric line feed

The resonant frequency is at 15.20 GHz which is different from the original value of 12.8 GHz. Due to high return loss and more secondary resonances we cannot select symmetric feed line in this design. Then we used different configuration of feed line to remove these problems.

5.4 Varying feed width

Simulations are for the designs where we have used the splitting method by varying the feed width to match the width using LineCalc for 1 x 2 and 2 x 2 array.

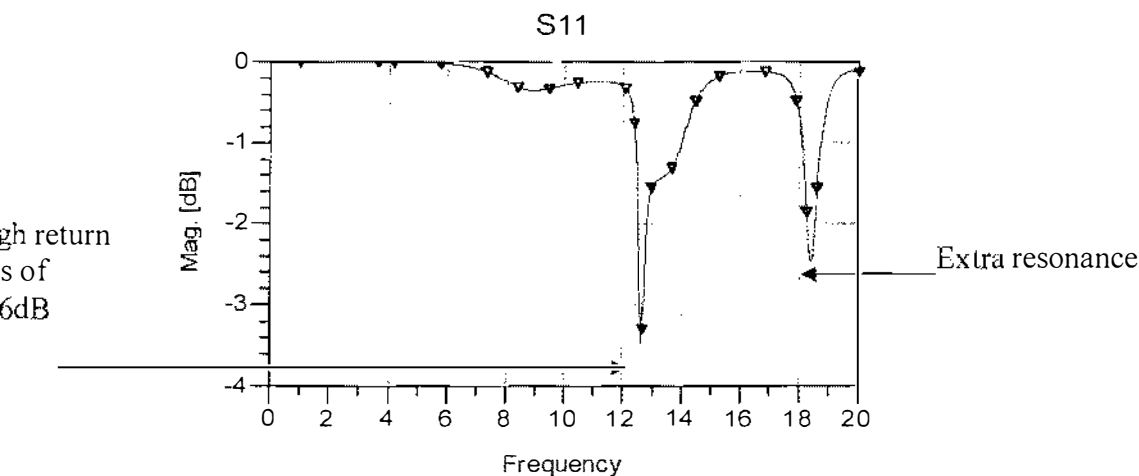

Figure 49: simulation result of 1x2 array antenna using splitting transmission line feed

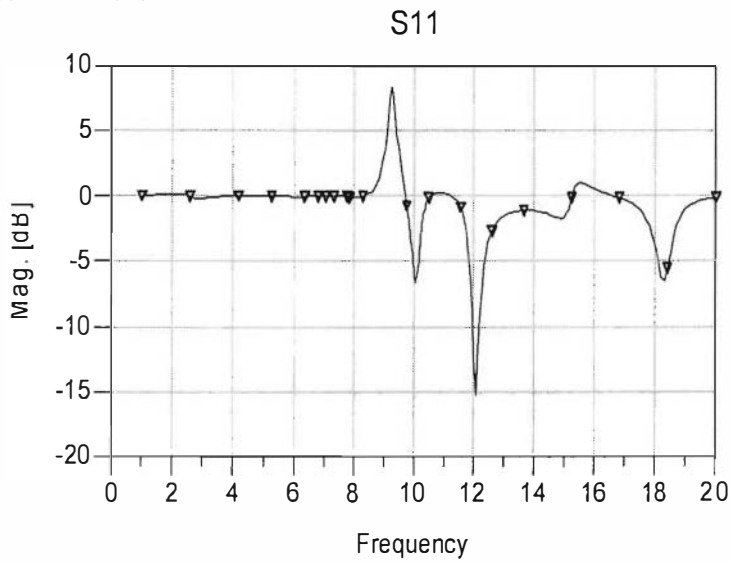

Figure 50: Simulation result of 2x2 array antenna using splitting transmission line feed

plitting the transmission line is not a good solution because it is unable to eliminate extra
ances and decrease return loss from the array antenna.

our approach was to use quarter wave transformer to solve the problems mentioned above.

5.5 $\lambda/4$ wave transformer in 1 x 2 array antenna

ave simulated the design using a Quarter-wave transformer in between the transmission
o remove impedance mismatch.

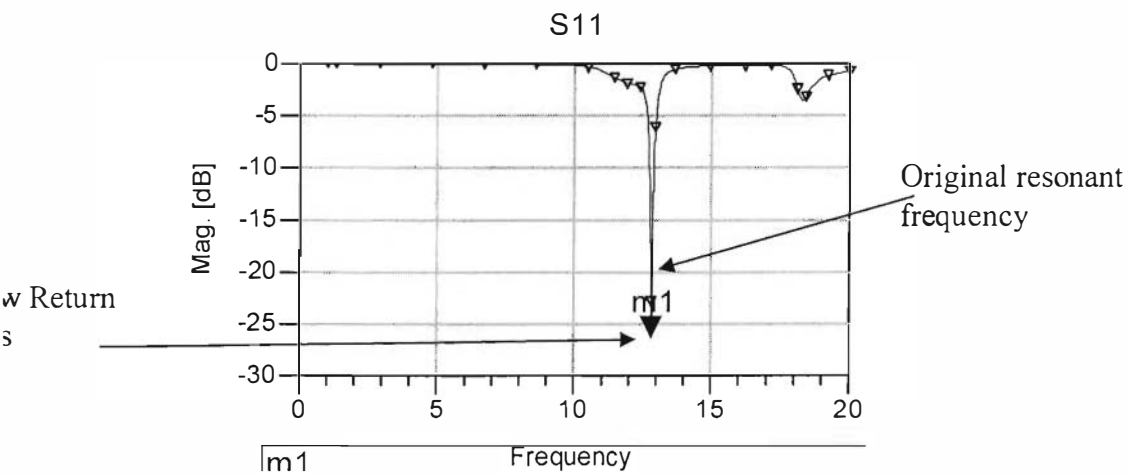

Figure 51: Simulation result of 1x2 array antenna using quarterwave

Resonant frequency is 12.84 GHz which is approximately equal to our original frequency. The use of quarter wave also reduces return loss which is -26.3 dB. As well as it removes other resonant frequencies from the circuit. So quarter wave is a healthy solution in array design. We can proceed further to 2 x 2 and 2 x 4 array design.

5.6 Quarter wave transformer for 2 x 2 and 2 x 4 array

We have applied the Quarter-wave transformer in the Arrays of 2 x 2 and 2 x 4; we have then simulated the results.

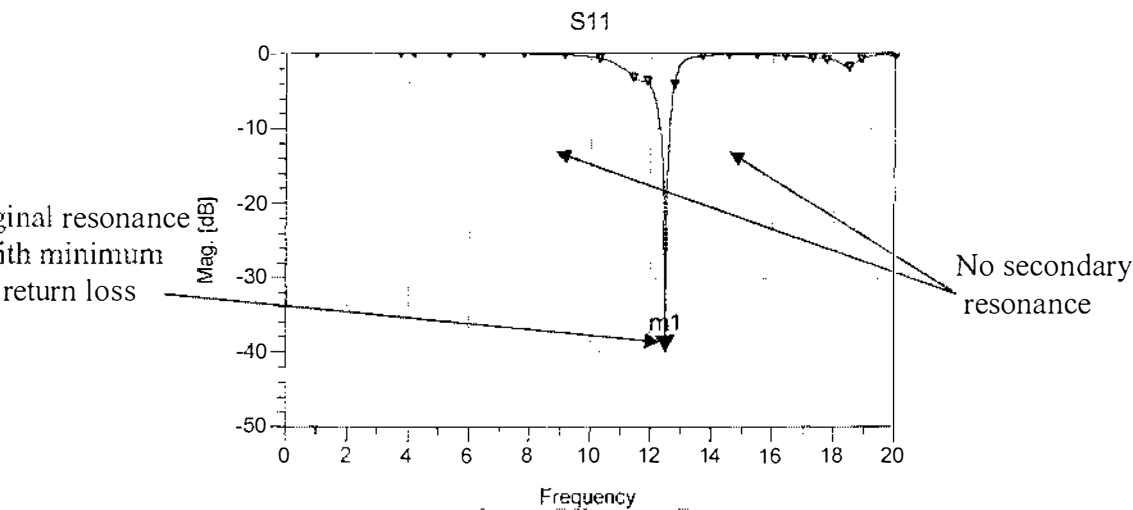

Figure 52: Simulation result of 2x2 array antenna using quarterwave. Return loss is -40.13 dB and resonant frequency is 12.48GHz and no extra resonance.

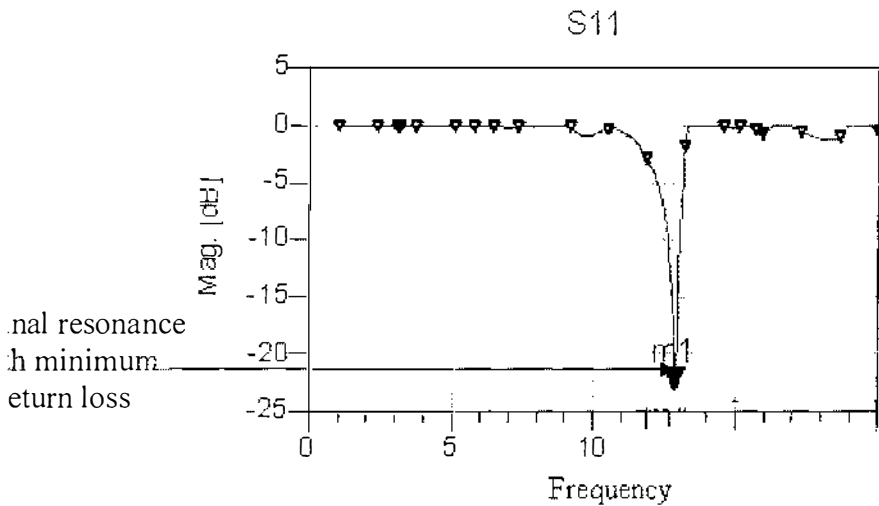

Figure 53: Simulation result of 2x4 array antenna using quarterwave

Return loss is -23.30 dB and resonant frequency is 12.88GHz and no extra resonance which is desirable. As all the parameters are much suitable so we can easily select as our solution

5.7 Folded Quarter Wave Array design 1 x 2, 2 x 2

We have folded the Quarter-wave in order to reduce the length then we have simulated the design by applying it in the Array of 1 x 2 and 2 x 2.

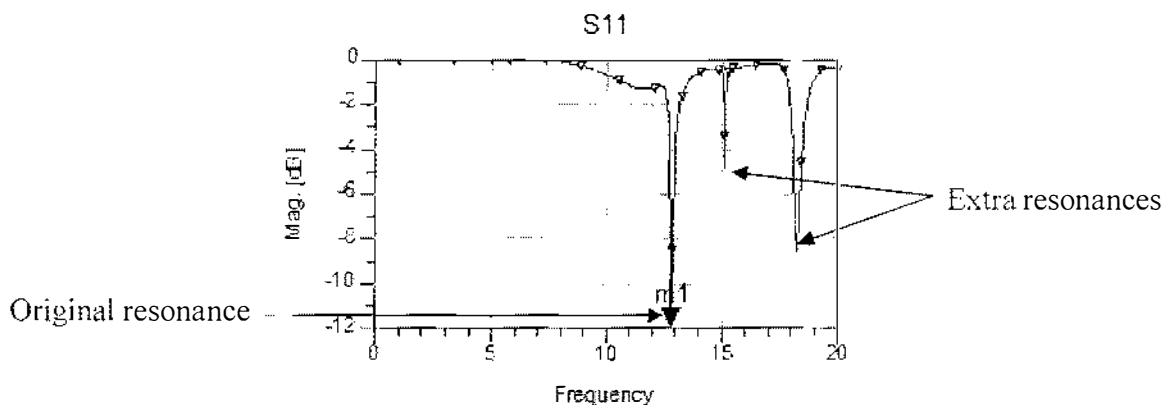

Figure 54: Simulation result of 1x2 array antennas using folded quarterwave

Here we can see some secondary resonances and high return loss though we used folded quarter wave. Here the return loss is -11.95dB.

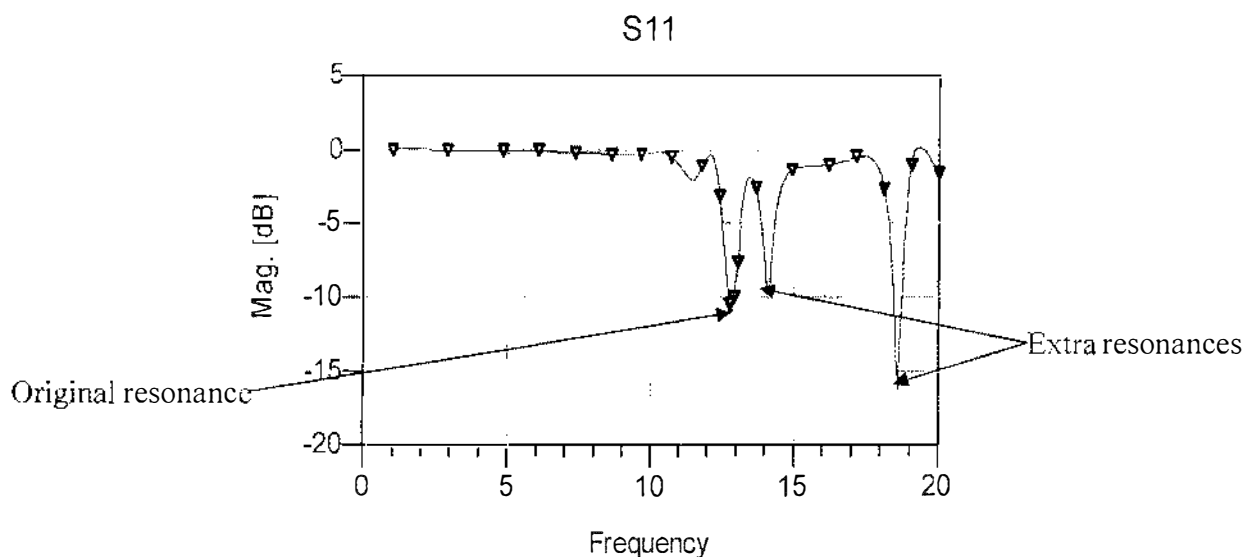

Figure 55: Simulation result of 2x2 array antennas using folded quarterwave

more distorted extra resonances are seen and return loss is also higher. So using only folded quarter wave is not a good solution.

5.8 Folded Quarter wave Array with Curved Turns

In order to match the impedance we need to keep the width identical along the line so we have curved the turns of the Folded Quarter-wave.

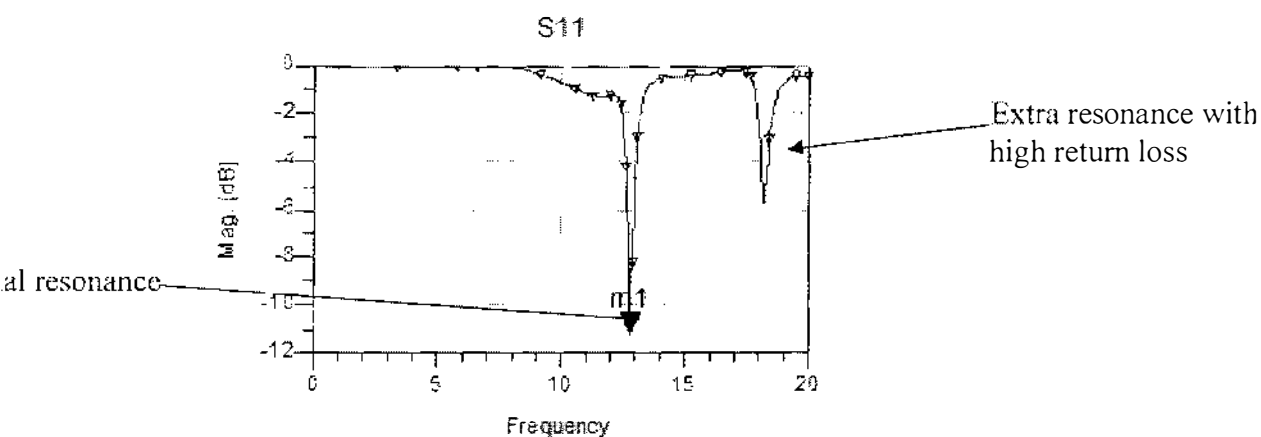

Figure 56: Simulation result of 1x2 array antenna using curved turns folded quarterwave

From the simulation it is clear that resonant frequency which is 12.79GHz is close to our original resonance 12.8GHz and return loss of the original frequency is -11.184dB. But there is an extra resonance and as it has a high return loss so it is acceptable.

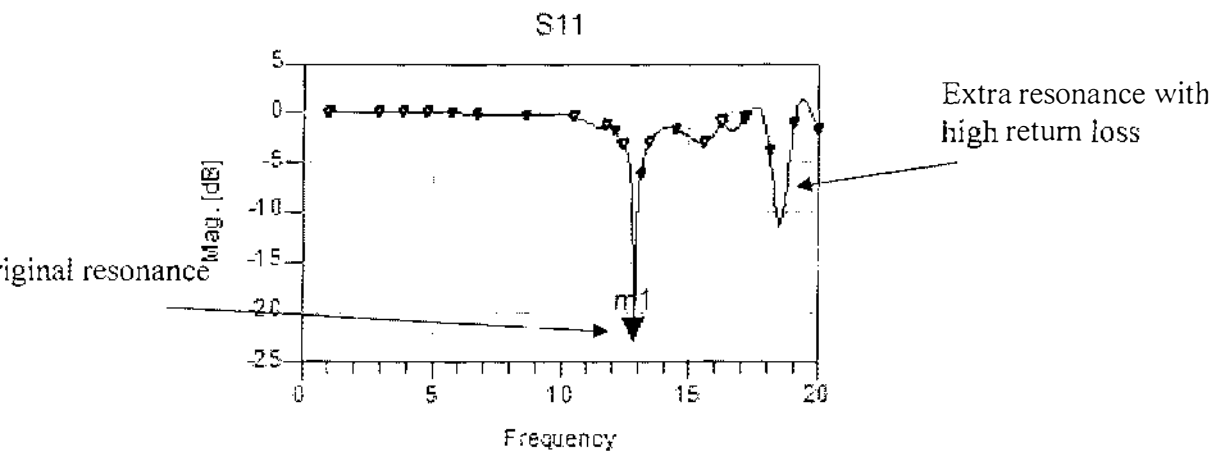

Figure 57: Simulation result of 2x2 array antenna using curved turns folded quarterwave

the resonant frequency (12.86GHz) is matched with original frequency and the return loss (-8.543dB) is also very low. We have an extra resonance but as it has high return loss so it is acceptable.

5.9 Folded Quarter wave Array with Mitered turns

To remove the impedance mismatch in the turns of a Folded Quarter wave we need to keep the width same as the straight line. We used Mitered option to make the width identical. We then simulated the S-parameter applying in 1 x 2 and 2 x 2 Array design

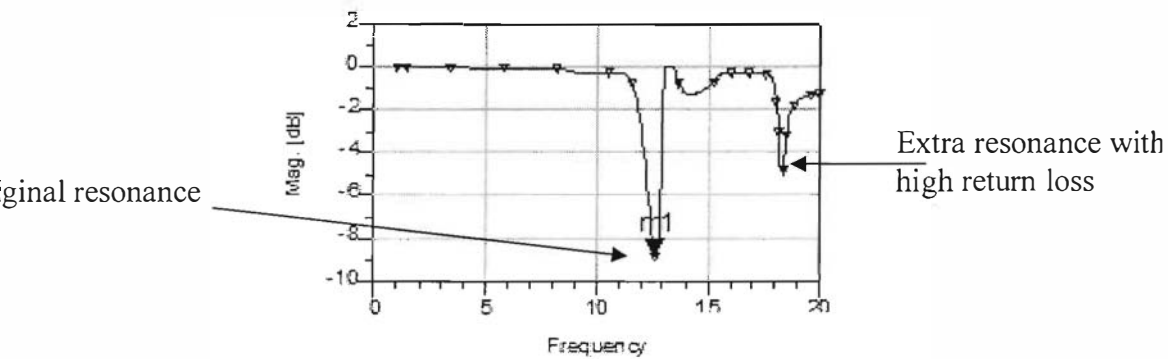

Figure 58: Simulation result 1x2 array antenna using mitered turns folded quarterwave

the resonant frequency is a little different from original frequency which is 12.61GHz and the return loss is -8.860dB.

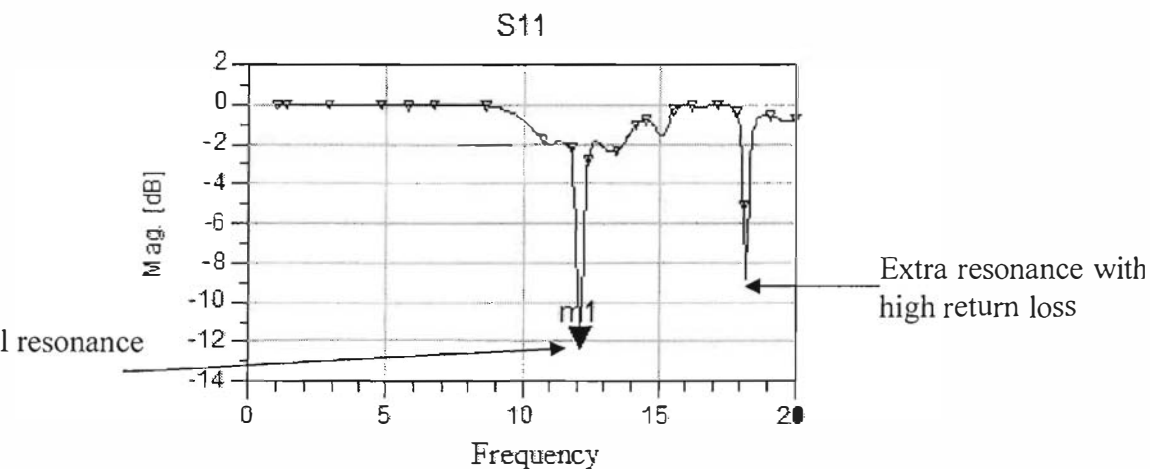

Figure 59: Simulation result of 2x2 array antenna using mitered turns folded quarterwave

Resonant frequency is quite different from original 12.08GHz and return loss is -12.393dB. So folded turns folded quarter wave is a better solution than mitered turns folding.

5.10 Varied lengths of folded quarter wave sections

Parameter is sensitive to the length of the folded Quarter-wave, so we varied the length of the folded Quarter-wave to verify the range of tolerance.

We have increased the length of the folded Quarter-wave by 5% and then by applying into a 2 x array we have simulated the S-parameter in ADS.

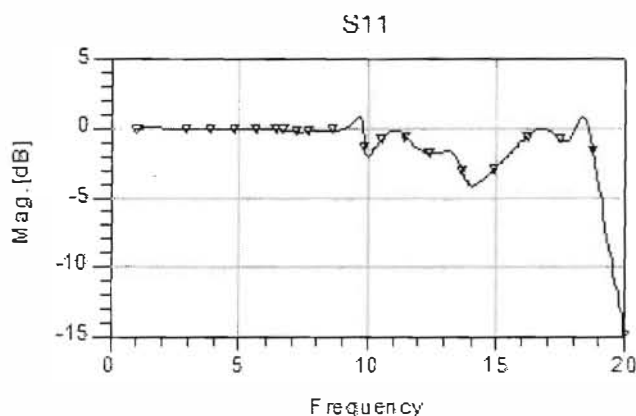

Figure 60: Simulation result of folded quarterwave after increasing the length by 5%

From the figure above we can see as we increase the length of the folded quarter wave by 5%, the S-parameter result is completely distorted and no original resonance is seen.

We have decreased the length of the folded Quarter-wave by 5% and then by applying into a 2 x array we have simulated the S-parameter in ADS.

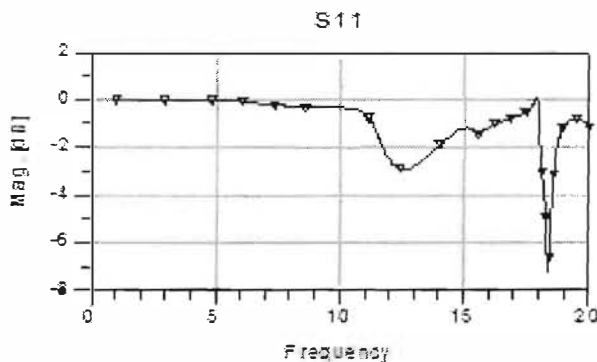

Figure 61: Simulation result of folded quarterwave after decreasing the length by 5%

We don't find any original resonance around 12 GHz and S-parameter result is also distorted like the previous one. So tolerance range of the length is within 5% from the original length.

can conclude by saying that varying the length of the Folded Quarter-wave distorted the S-parameter. So the sensitivity of the length is in between 5%.

5.11 Comparison of Rounded and Mitered turns

We have here simulated the 2 x 4 array antenna. We have applied both Curved turns folded quarter-wave and Mitered turns Folded Quarter wave then we have simulated the S parameter. The following S-parameter is for 2 x 4 array design where we have applied the curved turns folded Quarter-wave.

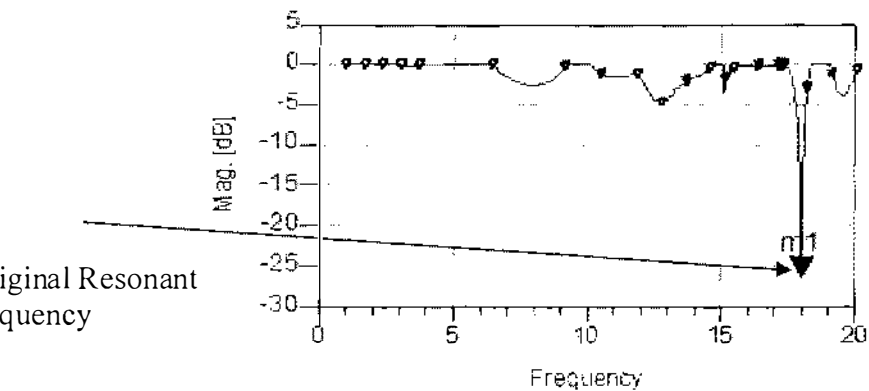

Figure 62: Simulation result of 2x4 array antenna using curved turns folded quarterwave

Resonant frequency is 17.99GHz and return loss is -26.31dB.

The following S-parameter is for 2 x 4 array design where we have applied the mitered turns folded Quarter-wave.

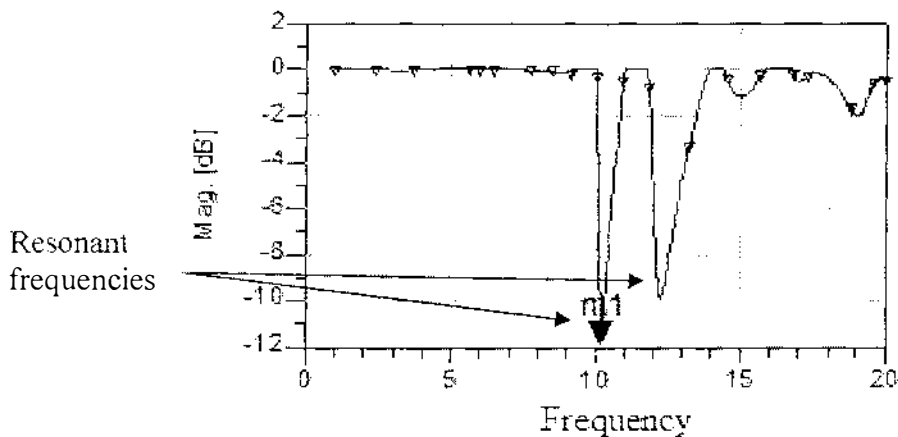

Figure 63: Simulation result of 2x4 array antenna using mitered turns folded quarterwave

the Resonant frequency is 10.25GHz and another one is 12.23GHz. Return loss is -11.92Db -9.93dB respectively. So we can conclude by saying that for every array size curved turns folded quarter wave is better solution than mitered turns folded quarter wave.

6 CONCLUSION

Our concern was to design a compact 12.8GHz Microstrip patch array antenna with minimum return loss. To achieve minimum reflection we had to match impedance from transmitter to receiver. For solving impedance mismatch at first we tried different configuration of feed position. Our observation was though optimum feed position played a vital role to get minimum reflection but it was not sufficient to reach our goal. So our next approach was using quarterwave between two transmission lines in an array. But we saw it require more space if we use quarterwave. That's why we had to think a solution to reduce space area because our focus was to design a compact array antenna.

As a solution we moved to folded quarterwave rather than using straight line quarterwave transformers. It helped us eliminate extra spaces but it affected the simulation result badly. Sharp edges of the folded quarterwave again introduced impedance mismatch as well as extra resonances which causes distorted simulation results. Next we used curved and mitered turns to fold the quarterwave transformer to reduce sharp edges in our design. We observed that curved turns folded quarterwave transformers produced more accurate result than mitered turn folding.

Using this methodology we designed a compact 12.8GHz microstrip patch array antenna with minimum return loss using curved turns folded quarterwave between two transmission lines. The simulations, data analysis and simulation have been established using ADS (Advanced Design System, by Agilent Tools). Thus, it can be concluded that our proposal holds.

7 FUTURE WORK

Based on our learning we have identified the following as possible future work.

- Folding the quarter wave changes the resonant frequency in some cases. This needs to be analyzed as to root cause the change. We used Curved and Mitered turns to reduce the problem but there are other issues which must be looked into.
- We limited the size of our arrays. To be able to receive or transmit larger amount of power, arrays with greater number of elements need to be investigated.
- The quarter wave transformer can be designed as ring circle so that the width remains the same along the line. Ring circle is a geometric figure. The benefit of the ring shaped line is that it will keep the width identical along the line. This is a potential feed structure for the array antennas in an array.
- A substrate with different dielectric constants and different thickness should be investigated to reduce the length of the Quarter-wave. This can simplify and make the design more compact.
- In our Design we reduce the area of the array antenna. However, if the antenna array is very large, we can then design a flexible array.

REFERENCES

- [1] H. Matzner, G. Sasson, M. Yacobi, and M. Haridim, "A Compact Broadside/ Endfire Printed Array Antenna", Hoian Academic Institute of Technology, December 2002.
- [2] J Lagerqvist, "Design and Analysis of an Electrically Steerable Microstrip Antenna for ground to air use," M.S. thesis, Dept. of Computer Science and Elect. Eng., Lulea University of Technology., May 2002.
- [3] A. Balanis, *Antenna Theory*, 2nd Ed. John Wiley & Sons Inc, 1997.
- [4] D. M. Pozar, and D. H. Schaubert, *Microstrip antennas: The Analysis and Design of Microstrip Antennas and Arrays*. John Wiley & Sons Inc, 1995.
- [5] J. R. James, *Handbook of microstrip antennas*, Peter Peregrinus Ltd, 1989.
- [6] A.W. Rudge, K. Milne, A. D. Olver, and P. Knight. *Handbook of Antenna Design*, Peter Peregrinus Ltd, 1983.
- [7] G. Breed, "The Fundamentals of patch antenna design and performance", Editorial Director, Summit Technical Media, March 2009.
- [8] R. W. Dearnley, "A broad-band transmission line model for a rectangular microstrip antenna," .IEEE Transactions., vol. 37, no. 1, pp. 6-15, Jan 1989
- [9] M. C. Horton, R.J. Wenzel, , "General Theory and Design of Optimum Quarter-Wave TEM Filters," .IEEE Transactions., vol. 13, no. 3, pp. 316-327, May 1965
- [10] V. R. Gupta, S. Kumar, and N. Gupta, "Design of Compact Microstrip Patch Array for wideband communication", Department of electrical and electronic engineering. Birla institute of technology.
- [11] S. Drabowitch et. al, *Modern antennas*, Dordrecht, Springer, Netherlands, 2005
- [12] R. E. Munson, *Microstrip Antennas*, Ball Communications Systems Division, 4th Edition.
- [13] Authorized licensed use limited to: IEEE Xplore. Downloaded on June 15, 2009 at 03:02 from IEEE Xplore. Restrictions apply.
- [14] S. Scalise, G.E. Corazza, C. Párraga Niebla, P. Chan, G. Giambene, F. Hu, A. Vanelli-Coralli, and M.A. Vázquez-Castro , "Towards the Revision of DVB-S2/RCS Standard for the Full Support of mobility," SSC Newsletter. November 2006.
- [15] T. Ren, R. J. La, and L. Tassiulas, "Optimal Transmission Scheduling with Base Station Antenna Array in Cellular Networks," IEEE INFOCOM 2004.
- [16] S. Horst, D. E. Anagnostou, G. E. Ponchak, E. Tentzeris, and J. Papapolymeroul, "Beam-Shaping of Planar Array Antennas Using Integrated Attenuators," Electronic Components and Technology Conference, 2007.
- [17] B. Allen, M. Ghavami, *Adaptive Array Systems*, 2nd Ed. John Wiley & Sons Inc, 2005
- [18] D. M. Pozar, and D. H. Schaubert, *Microstrip Antennas: The Analysis and Design of Microstrip Antennas and Arrays*, Wiley-IEEE Press, December 4, 2008.
- [19] *IEEE Std. 100 The Authoritative Dictionary of IEEE Standards Terms, 7th Edition*, The Institute of Electrical and Electronics Engineers, New York, 2000, page 391
- [20] R.W Beatty and B. C. Yates, "Microwave theory and techniques." .IEEE Transactions., vol. 17, no. 5, pp. 282-284, May 1969.
- [21] G. Gakir, L. Sevgi , "Design, Simulation and Tests of a Low-cost Microstrip Patch Antenna Arrays for the Wireless Communication," Tubitak, 2005
- [22] W. A. Imbriale, "Optimum designs of broad and narrow band parabolic reflector antennas fed with log-periodic dipole arrays," .IEEE Transactions., vol. 12, pp. 262-265, Jan 1974
- [23] K. Ogata, *System Dynamics*, University of Minnesota, 4th Edition, p.617



APPENDIX

Procedure of S-parameter simulation

Advanced Design System (ADS) is an electronic design automation software system produced by Agilent EEsof EDA; we have used this software to calculate the S-parameter. The procedure for the Microstrip Patch antenna design in layout using the momentum menu is described below.

First we opened the ADS software, From File menu we selected *New project*, we named it *EEE498_final_project*.

In the schematic window, from the layout menu we selected *Generate/update layout*.

In the layout window, from the Option menu we selected Preference, and then we selected the UNIT in millimeter (mm) from Layout unit tab.

Then we pulled down the option menu, in the Grid spacing we selected *<.05-1-100>*.

We pulled down the Insert menu, then selected Rectangle, putting the cursor in the black window we designed the patch which was of dimensions of 4.01 mm and 3.55 mm.

Then we designed the feed line width 0.47 mm. we placed the feed line on the left side of the rectangle plane. The feed line was placed 0.89mm away from the top of the patch.

We selected the rectangular patch and then by pressing the ctrl button we selected the *merged line*. We pulled down the Edit menu, and then we merged it to Union.

From the Momentum Menu we clicked on substrate then we selected Create/modify. In the substrate layers tab we renamed Air to Top and Aluminum to Dielectric from Substrate Layer menu.

Then we selected dielectric thickness to 20mil and then we set the dielectric constant $\epsilon_r = 4.4$ (real). We kept the Loss Tangent as default.

We then selected Layer Mapping tab and then clicked on dotted line (.....), then we clicked on Strip. Then apply and Ok.

From the Insert Menu we selected *Port* and attached it to feed line input.

Then we saved the file by the name "file1"

Then we pulled down the Momentum menu, clicked on Mesh and then we selected *compute*. We set it to 20 GHz. Then we clicked Ok.

After the mesh analysis is finished we again pulled down the momentum menu then clicked on simulation and selected *S-parameter*.

We set the start frequency 1 GHz and stop frequency 20 GHz for 25 sample points. Then we clicked on Apply and then we simulated the S-parameter.

We pulled down the momentum menu again and clicked on Component then we selected *Component Library*. Then Ok, ok, ok and yes to get out of the window.

Then from the main window we pulled down the insert menu and then clicked on New Schematic. From Insert Menu we clicked on Component and then we selected *component library*. Then we opened the file from the list by the name it was saved.

Then we placed the component in schematic window. We selected Simulation S-parameter. To terminate the port we placed a resistance on the port and grounded it. Then we selected *S-parameter simulation* and dragged it to schematic window. Double click on the *S-parameter*, we set the start frequency at 1 GHz and stop frequency at 20 GHz. We took 200 sample points.

Then we simulated the S parameter $S(1,1)$. In our design we did reduce the size of the length of the array antenna. In the future we can reduce it more according to the need in the device. If the device is large enough then we can design a flexible array. If the device requires a small array then we have to reduce the length of antenna size

Procedure of Quarter wave transformer Design in ADS

In our design software tool ADS we have designed the Quarter-wave transformer, the procedure of the design is described below.



Figure 64: Quarter-wave design in ADS

1. As our system was of 50ohm impedance and the width of the feed was 0.5 mm so we arbitrary selected 100 ohm transmission line. So to get 100 ohm line we used LinCalc option in ADS to find the width of the line for 100 ohm system.
2. In the Schematics window of ADS from the Tools menu option we selected LineCalc and then clicked on start LineCalc.
3. In the LineCalc window we inserted the values of $\epsilon_r = 9.6$, height of the Substrate $H = 20\text{mil}$, then we selected $Z_0 = 100$ ohm and for 10 GHz frequency we SYNTHESIZED the Width of the Transmission line which was measured 0.067 mm
4. From the Equation of we calculated the value of Z_0 which is the characteristic impedance of the Quarter wave transformer. Here $Z_{in} = \text{Input impedance or the Feed line impedance } 50$ ohm and $Z_L = \text{Load impedance which is Transmission line Impedance } 100$ ohm.
5. So using the equation we calculated the value to be 70.7 ohm
6. We repeated the procedure (3) where New Z_0 was 70.7 ohm, we then synthesized the width of the Quarter wave and measured width = 0.067 mm and length = 3.01 mm
7. With the given parameters we designed the Quarterwave in the ADS layout window (an example is shown above).