

**EAST  
WEST  
UNIVERSITY**



**Department of Electronics and Communications Engineering**

INTERNSHIP REPORT ON

**Networking System of DOZE internet**



*Prepared by:*

**Poojaghosh**

ID: 2011-3-58-020

Dept. Of ECE

East West University

*Supervised by:*

**Dr.M.MofazzalHossain**

August 2016

## **Declaration**

This is certified that the internship report is done by me under the course “Research/Internship(ETE-498)”. It has not been submitted elsewhere for the requirement of any degree or any other purpose except for publication.

-----  
**Poojaghosh**

**ID: 2011-3-58-020**

**Dept. Of ECE**

## Acceptance

This internship report is submitted to the **Department of Electronics and Communication Engineering, East West University** is submitted in partial fulfillment of the requirements for the degree of **B.Sc in ECE** under complete supervision of the undersigned.

---

**Dr.M.MofazzalHossain**  
**Professor**  
Dept. of ECE

---

**Wardha Anjum Laboni**  
Deputy. Manager, NOC  
DOZE internet.

## Acknowledgement

At first I wish to convey my cordial thanks and gratitude to Almighty Allah for everything. I would like to thank my parents and everyone else who has supported me all the way through to complete the Internship program successfully and also to those who rendered their cooperation in making this report.

I would like to thank **Dr.M.MofazzalHossain(Professor, Dept. of ECE, EWU)**for guided me with lots of effort and time to perform the internship program.

I want to convey my gratefulness to **Wardha Anjum Laboni (Deputy. Manager, NOC,DOZE internet.)**Who helped me greatly by providing valuable suggestion whenever required my internship report “**Networking System of DOZE internet.**”They also gave the opportunity to hold that flagship of the topic.

I would also like give to acknowledgments everyone of the System Management Department of **DOZE internet**. For providing suggestion on how to work and what is the procedure to work in a practical manner and also how to make the internship report in a better way. They helped me in many ways by allowing whatever assistance I needed. Otherwise it was not possible for me to complete my report.

## **Abstract**

This report focuses on the whole networking system of an ISP company. Internet Service Provider (ISP) can provide various services like data connectivity service, Internet service, Security ensures, Fiber optic networks, Network infrastructure design and maintenances and support. In enterprise network infrastructure, ISPs provide redundant links or backup mechanism that can keep up a network even when unplanned outage occurs. To ensure maximum availability of a designed network it is difficult when power outage or load shedding occurs.

If we can design a network that is more beneficial, more secure, highly reliable and faster, then it will be more useful for any organization.

## **Table of Contents**

|                            |   |
|----------------------------|---|
| Title pages-----           | 1 |
| Letter of Transmittal----- | 2 |
| Declaration-----           | 3 |
| Acceptance-----            | 4 |
| Acknowledgement-----       | 5 |
| Abstract-----              | 6 |

### **Chapter 1. Introduction**

|                               |       |
|-------------------------------|-------|
| Background of the study ----- | 9     |
| About Doze internet -----     | 10-12 |

### **Chapter 2. Devices**

|                            |       |
|----------------------------|-------|
| 2.1:Router -----           | 13-15 |
| 2.2: Switch -----          | 16    |
| 2.3: Media Converter ----- | 17    |
| 2.4: ONU -----             | 18    |
| 2.5: Fiber Optic -----     | 19    |

## **Chapter 3. Network Designing**

|  |    |
|--|----|
| 3.1: Design of a network-----                  | 20 |
| 3.2: Objectives of a network design -----      | 21 |
| 3.3: Requirements to design a network-----     | 22 |
| 3.4:Backbone Network Design-----               | 23 |
| 3.5:Network Planning-----                      | 24 |
| 3.6: Overall design of a Network Planning----- | 25 |
| 3.7:NOC zone of DOZE internet-----             | 26 |

## **Chapter 4. Internship Activities**

|                                   |       |
|-----------------------------------|-------|
| 4.1: ISP NOC support system ----- | 27    |
| 4.2: Nagios -----                 | 28-30 |
| 4.3: Cacti with MRTG -----        | 31-32 |

## **Chapter 5. Conclusion**

|                 |    |
|-----------------|----|
| Conclusion----- | 33 |
|-----------------|----|

|                         |       |
|-------------------------|-------|
| <b>References</b> ----- | 34-35 |
|-------------------------|-------|

# Chapter 1

## Introduction

In the broadest terms, people like to view the Internet as a cloud, you put your data in one place, it comes out the place you want it to on the other side. In reality the internet is tens of thousands kilometers of fiber optic cable, hundreds of thousands to millions of kilometers of copper wire, and hardware and software connecting them all together in a redundant, fast, and self-sufficient network. But not to worry, it's not that bad: you only have to worry about a very small portion of the network, you can let someone else worry about the rest, and you even get someone to tell at when things go wrong.

I had an opportunity to work with Internet Service Provider (ISP) service provider that is DOZE internet. I consider myself timely to get a chance to take a deep look to their development methods, working models, deals and industrial behavior. And I was intending to look into the Networking Industry and how it looks like practically, how they interact with their clients, how they design a system and what are their rules in their environmental work.

I got the chance to work in Network Operation Center (NOC) in DOZE internet. We know computer networking is the principal part of our modern life. I decided to know about computer networking and how does it work, how to design a wide area network and backbone network, what are the important keys to design a beneficial network, how can I design cost effective network and how to mitigate downtime of a network.



## About DOZE internet

### Name and Address

Name of the Company: DOZE internet

role: Systems Solutions development Technologies Limit  
address: Highway Homes- 2nd Floor,, KA-32/6 Shahjadpur, PragotiSharoni,, Gulshan.,,  
Dhaka  
country: BD  
phone: +8801713404007  
fax-no: +8801713404007  
e-mail: infrastructure@ssd-tech.com  
admin-c: SSDT2-AP  
tech-c: SSDT2-AP  
nic-hdl: SSDT2-AP  
mnt-by: MAINT-SSDTL-BD  
changed: hm-changed@apnic.net 20140811  
source: APNIC

% Information related to '103.239.254.0/25AS63526'

route: 103.239.254.0/25  
descr: SSDTECH Route Object3\_1  
origin: AS63526  
mnt-by: MAINT-SSDTL-BD  
changed: hm-changed@apnic.net 20140811  
source: APNIC

% This query was served by the APNIC Whois Service version 1.69.1-APNICv1r0 (UNDEFINED)

## **Values:**

The Values objects of DOZE internet are set out as follows

- To facilitate high speed, dedicated broadband connectivity directly to client's premises over a radio/wireless and Optical Fiber link.
- To provide data connectivity almost anywhere in the country through its network.
- Create employment opportunity in ICT sector.
- To provide enterprise-grade data security solutions to corporate houses in order to protect their sensitive information.

## **Services:**

### Internet

- Corporate
- Small Business
- Home user

### Data Communication

- Nationwide Secure Connectivity
- Dark Fiber Connectivity
- Clear Channel Connectivity
- Capacity Based Connectivity

### Network

- Corporate Network
- Small Business Network
- Personal Area Network

## **Solutions:**

### Enterprise

- Network
- IP-VPN
- E-Mail

### System Integration

- Customized Solution
- Training

## Chapter 2

### Devices

#### 2.1 Router

A **router** is a networking device that forwards data packets between computer networks. Routers perform the "traffic directing" functions on the Internet. A data packet is typically forwarded from one router to another through the networks that constitute the internetwork until it reaches its destination node.

A router is connected to two or more data lines from different networks (as opposed to a network switch, which connects data lines from one single network). When a data packet comes in on one of the lines, the router reads the address information in the packet to determine its ultimate destination. Then, using information in its routing table or routing policy, it directs the packet to the next network on its journey. This creates an overlay internetwork.



Figure 2.1 Router

The most familiar type of routers are home and small office routers that simply pass data, such as web pages, email, IM, and videos between the home computers and the Internet. An example of a router would be the owner's cable or DSL router, which connects to the Internet through an ISP. More sophisticated routers, such as enterprise routers, connect large business or ISP networks up to the powerful core router that forward data at high speed along the optical fiber lines of the Internet backbone. Though routers are typically dedicated hardware devices, use of software-based routers has grown increasingly common.

**Onubha router:**In DOZE internet they are using **onubha** router. It's their own company creation. Onubha (UG1000) (Unified Gateway) is a network gateway that serves as a router, firewall, proxy, bandwidth controller & profiler, softswitch and IVR. It is a single gateway that will serve all corporate needs related to IP and voice service network. The product is designed in a modular structure and user can choose the modules required only. Unified Gateway comes with a GUI and CLI based configuration interfaces. The gateway can be deployed as Virtual Machine as well.



Figure 2.2 Onubha Router

**Step 1:** Connect LAN Cable to eth0 port



**Step 2:** Connect another cable with rest of the Ethernet port for WAN purposes.



**Step 3:** Power Connectivity



Figure 2.3 LAN, WAN and power connectivity in Onubha Router

## 2.2 Switch

A network switch also called switching hub, bridging hub, officially MAC bridge is a computer networking device that connects devices together on a computer network, by using packet switching to receive, process and forward data to the destination device. Unlike less advanced network hubs, a network switch forwards data only to one or multiple devices that need to receive it, rather than broadcasting the same data out of each of its ports.



Figure 2.4 Switch

A network switch is a multiport network bridge that uses hardware addresses to process and forward data at the data link layer (layer 2) of the OSI model. Switches can also process data at the network layer (layer 3) by additionally incorporating routing functionality that most commonly uses IP addresses to perform packet forwarding; such switches are commonly known as layer-3 switches or multilayer switches. Besides most commonly used Ethernet switches, they exist for various types of networks, including Fiber Channel, Asynchronous Transfer Mode, and InfiniBand.

## 2.3 Media Converter

A fiber media converter is a simple networking device that makes it possible to connect two dissimilar media types such as twisted pair with fiber optic cabling. They were introduced to the industry nearly two decades ago, and are important in interconnecting fiber optic cabling-based systems with existing copper-based, structured cabling systems. They are also used in metropolitan area network (MAN) access and data transport services to enterprise customers.



Figure 2.5 Media Converter



## 2.4ONU (optical network unit)

**Optical network unit (ONU)** is the user side equipment in the GEPON (Gigabit Ethernet Passive Optical Network) system designed for indoor residential installation. Optical network unit is used together with OLT in FTTH network, it provides data port, phone port and CATV port, 10/100M auto-negotiation, full bandwidth up to 200Mbps in full duplex mode, which can support the users with many kinds of broadband services such as VOIP, HDTV, and video conferences etc. optical network unit is economic and high efficient equipment and play an important role in the FTTH fiber optic network.



Figure 2.6 Optical network unit



Figure 2.7 Optical network unit

## 2.5 Fiber Optic

Optical fiber or fiber optic refers to the medium and the technology associated with the transmission of information as light pulses along a glass or plastic strand or fiber.

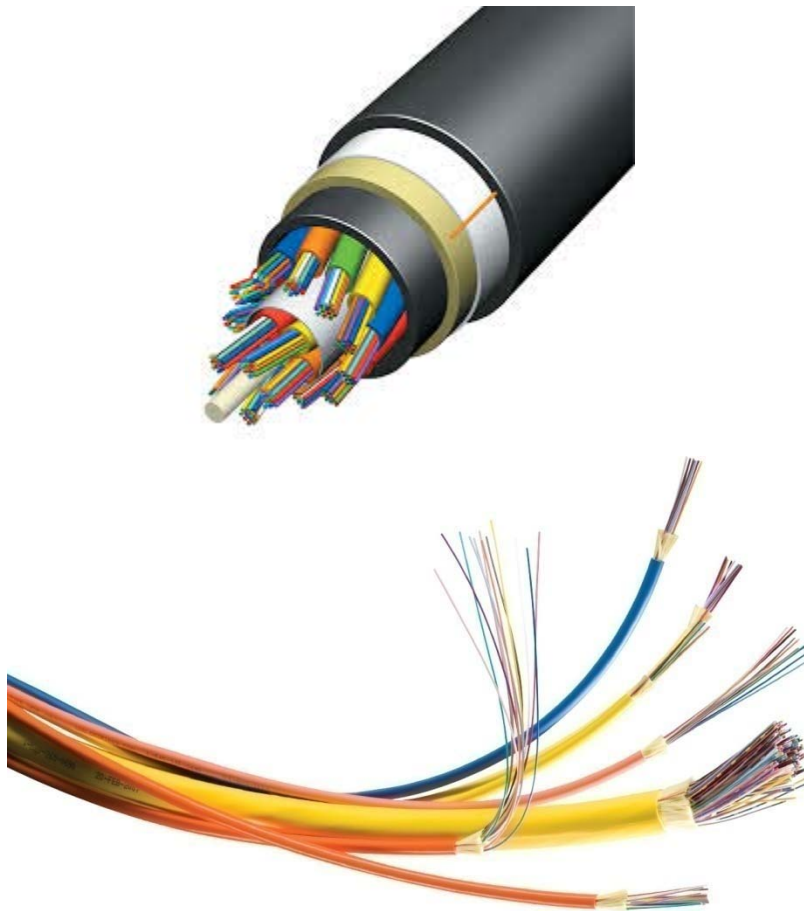

**Figure 2.8**Optical Fiber

Advantages of Fiber Optic cable:

- Greater bandwidth than metal cables. Large carrying capacity.
- Less susceptible than metal cables to interference.
- Much thinner and lighter than metal wires.
- Data can be transmitted digitally rather than analogically.
- Fiber optic cables costs much less to maintain.

# Chapter 3

## Computer network design

### 3.1 Design of a Network

Below the steps of a business network design. It will fulfill all of the requirements of any organization.

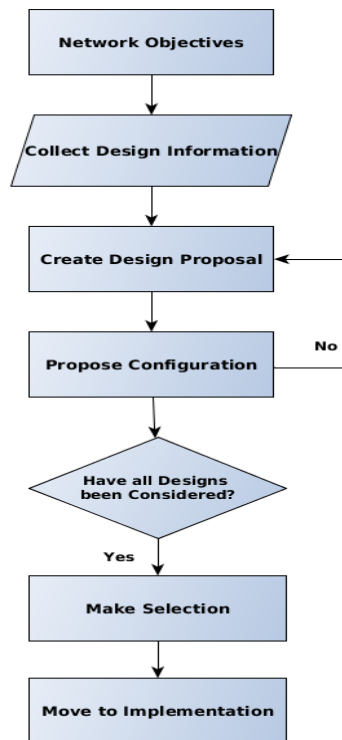

Figure 3.1 Design steps of a businessnetwork

### **3.2 Objectives of a network design:**

- a) Who are the users of this network and what are the requirements?
- b) What types of application will be supported?
- c) Does the design replace of existing network?
- d) Overall Responsible for network management
- e) What is the budget?
- f) designed consideration
- g) Do your network and its data need to have built-in security?

### **3.3 Requirements to design a network:**

- a) Bandwidth Requirements
- b) Performance Requirements
- c) Protocols Required
- d) Quality of Service/Type of Service (QoS/ToS)
- e) Sensitivity to Packet Loss and Delay
- f) Multicast
- g) Scalability
- h) Security
- i) Way of troubleshooting.

## 3.4 Backbone Network Design

To design a network, we need to follow some rules or steps that create a network more efficient and give high performance. A designed network has some goals that are discussed earlier.

- I. Scalability
- II. Availability
- III. Security
- IV. Manageability

To fulfill the fundamental goals of a network must be built an architecture that allows for both flexibility and growth.

Hierarchical networks have some advantages over flat network designs. The benefit of hierarchical design is that local traffic remains local. Only traffic goes to other networks and it's moved to a higher layer. A flat network using Layer-2 devices provide to control broadcasts or to filter undesirable traffic. As more devices and applications are added to a flat network then response times degrade until the network becomes unusable.

Keeping all of the above, we can use the hierarchical method to design of our desire network. There are some benefits of hierarchical network that are given below.

Actually hierarchical network is divided into three layers.

- 1) Core layer: Connects distribution layer devices
- 2) Distribution layer: Interconnects the smaller local networks
- 3) Access layer: Provides connectivity for network hosts and end devices

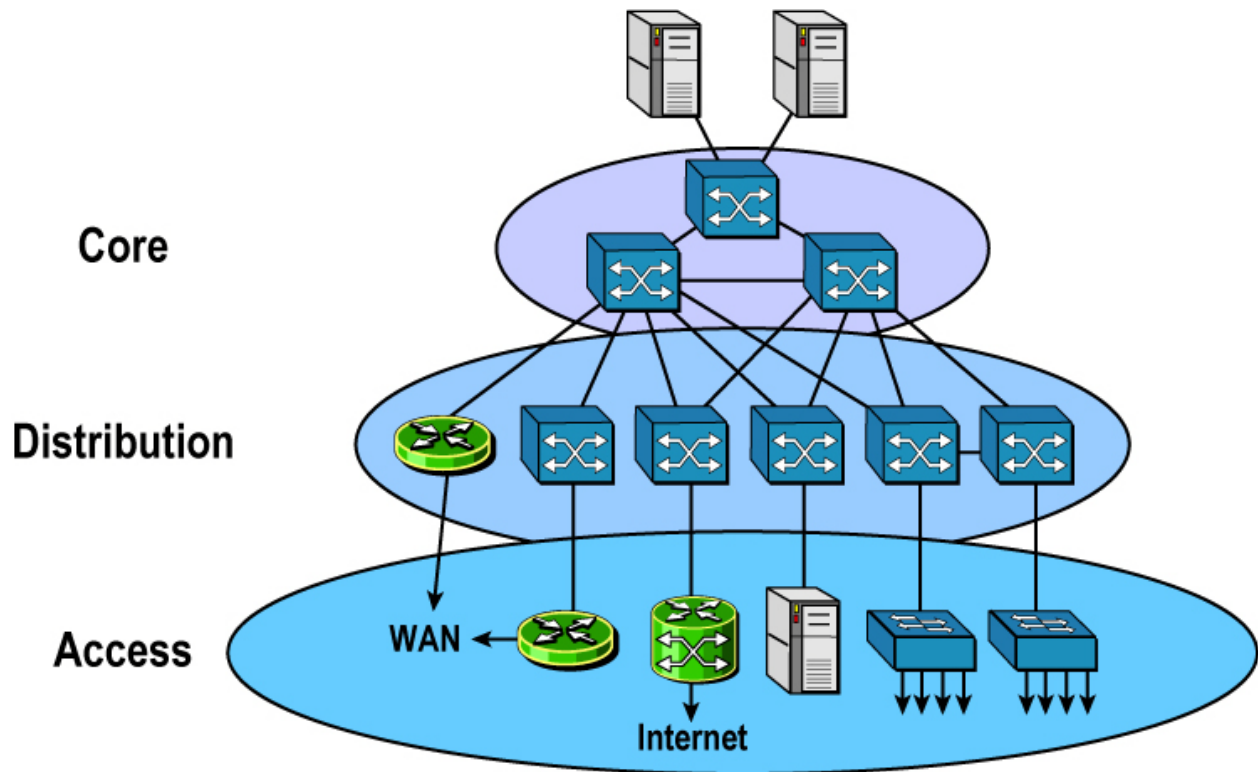

Figure 3.2 Hierarchical Design of a Network.

For long distance we can use fiber optic cable or radio connectivity for backbone connection. Fiber optic and radio connectivity is more efficient than Ethernet cable. Due to signal degradation we cannot use Ethernet cable long distance. On the other hand, by using optical fiber and radio connectivity we can transfer signal for long distance. Most of the backbone network is connected by fiber optic cable or radio connectivity.

### 3.5 Network Planning

A typical task has to follow to perform a proper planning of a network that can solve the complexity. A planned network has to perform of the business of an organization. In that case, a perfect network plan is followed to the proper business plan

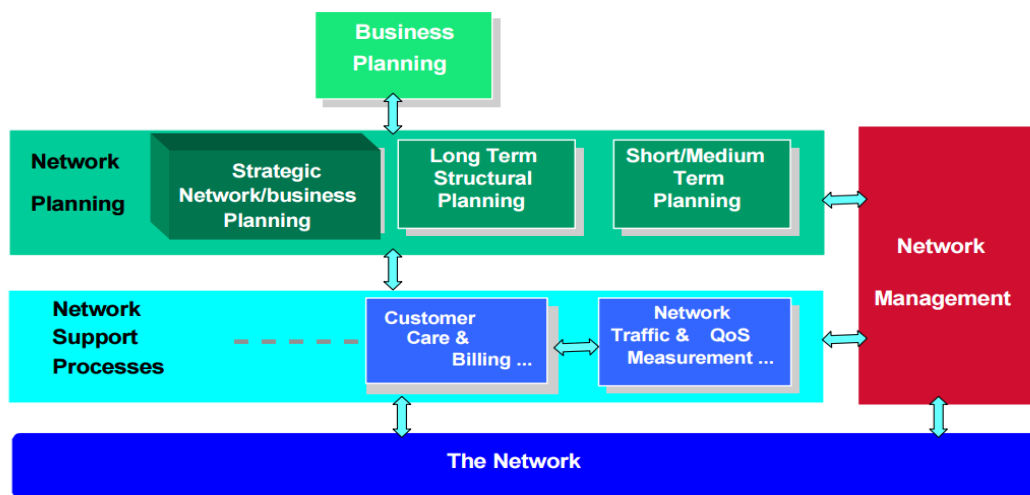

Figure 3.3 Network planning processes

**Long Term Planning (LTP):** Long lifetime and large investments for their deployment.

Strategic Planning:

- Technology
- Network mechanism
- Recovery mechanism

Fundamental Planning:

- Topology planning
- Allocation of function in network nodes
- Distribution functions in network nodes.

- Resource optimization
- **Medium Term Planning:** Capacity upgrading of the network nodes and links. This always following the long-term (LT) deployment strategies.
- **Short Term Planning:** The routes and the telecommunications systems that support a demand on this planning

### 3.6 Overall design of a Network Planning

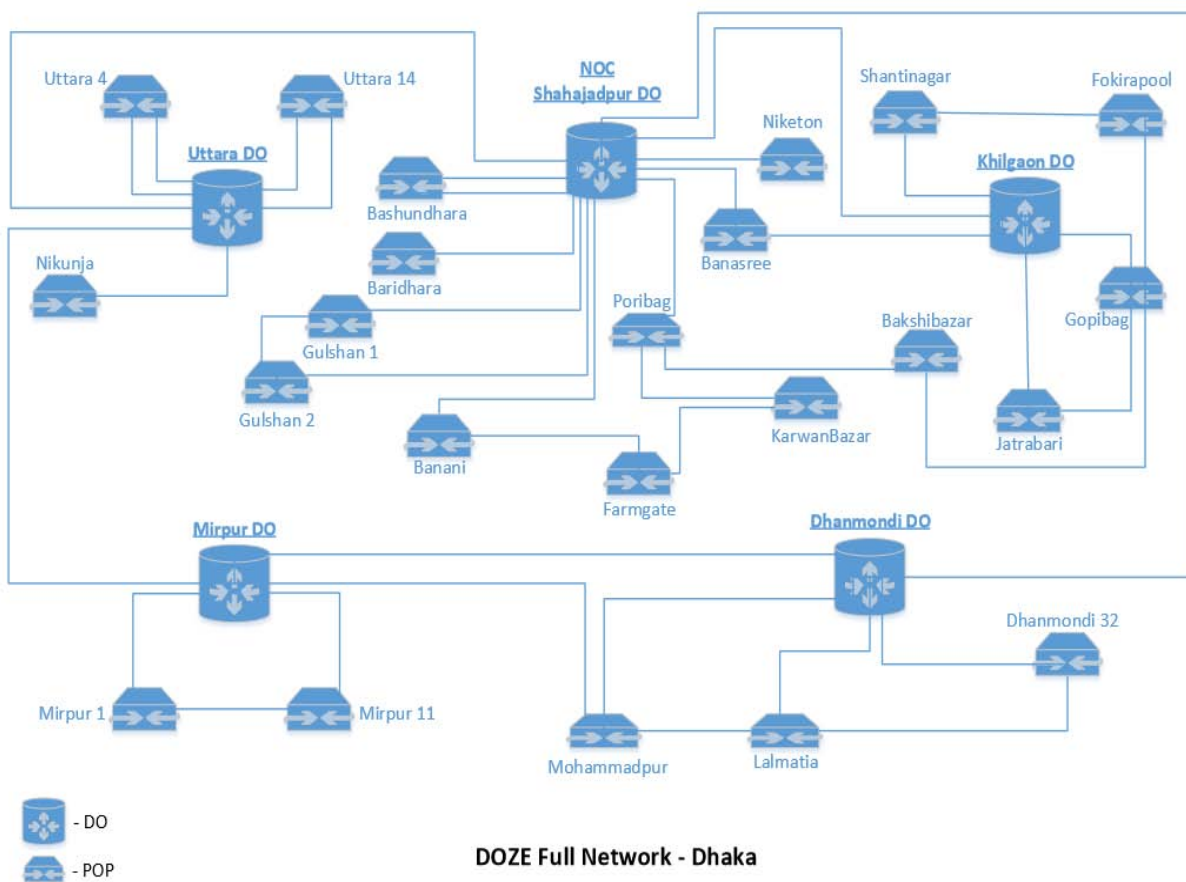

Figure 3.4 Overall design of a Network Planning



### 3.7 NOC zone of DOZE internet

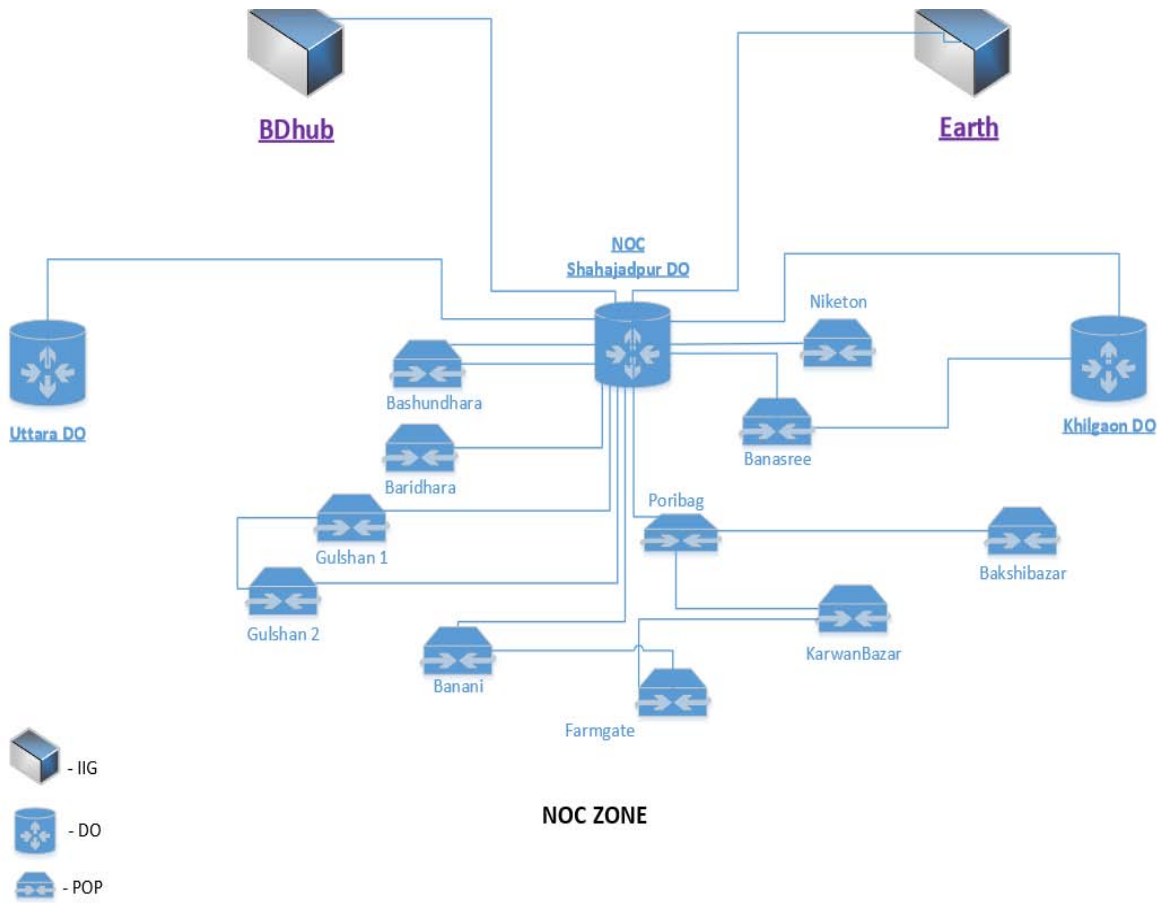

Figure 3.5 NOC zone of DOZE intern

## Chapter 4

### Internship Activities

In this paper is about ISP network design and maintenance in Network Operation Center (NOC). The main works of NOC is to ensure high security, proper maintenance service and reliable connection to the clients.

#### 4.1 ISP NOC support system

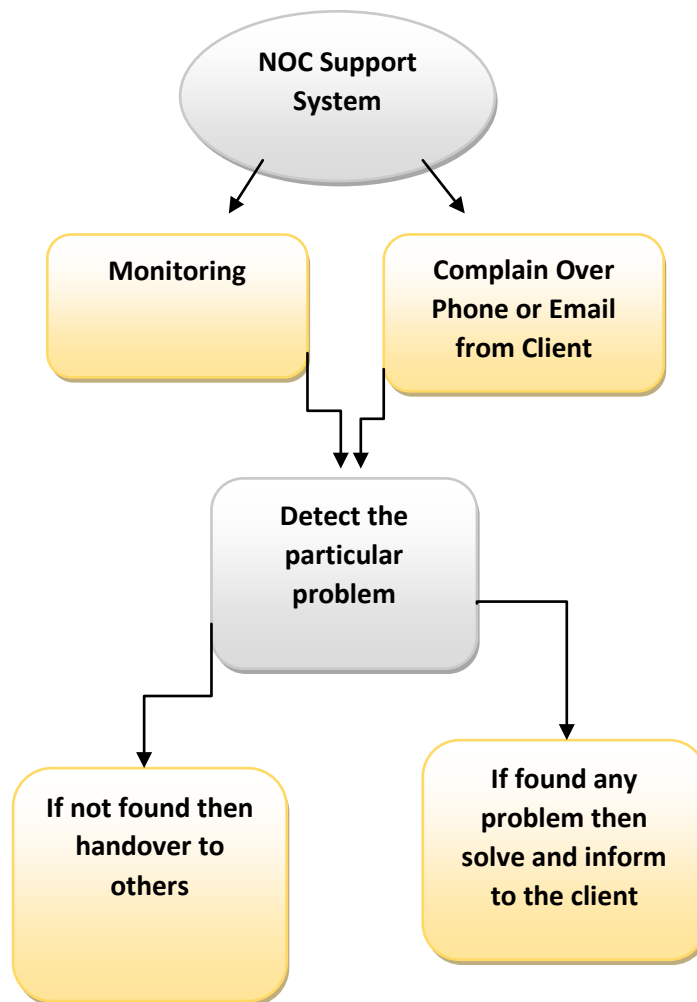

Figure 4.1 NOC support system of DOZE

To achieve these features the main task of NOC is monitoring all of the connections. For monitoring purposes DOZE internet uses Network Performance Monitoring tools like GC portal , Nagios, Cacti with MRTG.

## **4.2Nagios**

- Nagios is an open source network monitoring application. It is originally designed to run under Linux.It watches hosts and services that you specify, alerting you when things go bad and when they get better.
- Nagios network analyzer provides an in-depth look at all network traffic sources and potential security threats allowing system admins to quickly gather high-level information regarding the health of the network as well as highly granular data for complete and thorough network analysis.

- General
  - Home
  - Documentation
- Current Status
  - Tactical Overview
  - Map
  - Hosts
  - Services
  - Host Groups
    - Summary
    - Grid
  - Service Groups
    - Summary
    - Grid
  - Problems
    - Services
    - (Unhandled)
    - Hosts (Unhandled)
    - Network Outages
- Quick Search:
- Reports
  - Availability
  - Trends
  - Alerts
    - History
    - Summary
    - Histogram
  - Notifications

### Current Network Status

Last Updated: Tue Aug 9 13:52:04 BDT 2016  
 Updated every 30 seconds  
 Nagios® Core™ 4.0.1 - www.nagios.org  
 Logged in as nagiosadmin

### Host Status Totals

| Up                           | Down | Unreachable               | Pending |
|------------------------------|------|---------------------------|---------|
| 65                           | 0    | 0                         | 0       |
| <a href="#">All Problems</a> |      | <a href="#">All Types</a> |         |
| 0                            |      | 65                        |         |

### Service Status Totals

| Ok                           | Warning | Unknown                   | Critical | Pending |
|------------------------------|---------|---------------------------|----------|---------|
| 1                            | 0       | 0                         | 0        | 0       |
| <a href="#">All Problems</a> |         | <a href="#">All Types</a> |          |         |
| 0                            |         | 1                         |          |         |

[View Service Status Detail For All Host Groups](#)  
[View Status Overview For All Host Groups](#)  
[View Status Summary For All Host Groups](#)  
[View Status Grid For All Host Groups](#)

### Host Status Details For All Host Groups

Limit Results:

| Host             | Status | Last Check          | Duration       | Status Information                         |
|------------------|--------|---------------------|----------------|--|
| Bakshibazar_ACR  | UP     | 08-09-2016 13:48:22 | 0d 1h 19m 39s  | PING OK - Packet loss = 0%, RTA = 4.29 ms  |
| Bakshibazar_OLT  | UP     | 08-09-2016 13:48:16 | 0d 1h 19m 45s  | PING OK - Packet loss = 0%, RTA = 1.45 ms  |
| Banani-OLT       | UP     | 08-09-2016 13:48:41 | 1d 4h 47m 55s  | PING OK - Packet loss = 0%, RTA = 1.96 ms  |
| Banani_ACR       | UP     | 08-09-2016 13:50:30 | 4d 6h 51m 4s   | PING OK - Packet loss = 0%, RTA = 1.10 ms  |
| Banasree_ACR     | UP     | 08-09-2016 13:48:03 | 8d 22h 8m 48s  | PING OK - Packet loss = 0%, RTA = 1.05 ms  |
| Banasree_OLT     | UP     | 08-09-2016 13:47:01 | 0d 17h 13m 33s | PING OK - Packet loss = 0%, RTA = 1.70 ms  |
| Baridhara_OLT    | UP     | 08-09-2016 13:49:48 | 0d 17h 10m 48s | PING OK - Packet loss = 0%, RTA = 1.33 ms  |
| Bashundhara_ACR  | UP     | 08-09-2016 13:46:57 | 3d 2h 15m 6s   | PING OK - Packet loss = 0%, RTA = 0.96 ms  |
| Bashundhara_OLT  | UP     | 08-09-2016 13:47:27 | 0d 17h 13m 9s  | PING OK - Packet loss = 0%, RTA = 1.11 ms  |
| Chalantika_ACR   | UP     | 08-09-2016 13:48:01 | 3d 0h 21m 44s  | PING OK - Packet loss = 0%, RTA = 1.96 ms  |
| Chalantika_OLT   | UP     | 08-09-2016 13:48:00 | 3d 0h 21m 29s  | PING OK - Packet loss = 0%, RTA = 2.32 ms  |
| Chittagong_CORE  | UP     | 08-09-2016 13:50:18 | 1d 0h 31m 27s  | PING OK - Packet loss = 0%, RTA = 44.98 ms |
| Chittagong_DIS   | UP     | 08-09-2016 13:46:57 | 0d 17h 13m 49s | PING OK - Packet loss = 0%, RTA = 47.14 ms |
| Comilla_CORE     | UP     | 08-09-2016 13:51:42 | 0d 0h 15m 30s  | PING OK - Packet loss = 0%, RTA = 10.06 ms |
| Comilla_DIS      | UP     | 08-09-2016 13:47:38 | 0d 0h 14m 30s  | PING OK - Packet loss = 0%, RTA = 7.94 ms  |
| Dhanmondi_32_OLT | UP     | 08-09-2016 13:48:58 | 2d 3h 49m 4s   | PING OK - Packet loss = 0%, RTA = 2.98 ms  |
| Dhanmondi_DIS_A  | UP     | 08-09-2016 13:51:59 | 0d 17h 13m 40s | PING OK - Packet loss = 0%, RTA = 1.49 ms  |

Figure 4.2 Nagios

| Service Name              | Status | Last Check Time     | Duration       | Performance Data                            |
|---------------------------|--------|---------------------|----------------|---|
| Dhanmondi_32_OLT          | UP     | 08-09-2016 14:59:54 | 2d 4h 59m 32s  | PING OK - Packet loss = 0%, RTA = 3.00 ms   |
| Dhanmondi_DIS_A           | UP     | 08-09-2016 14:57:51 | 0d 18h 24m 8s  | PING OK - Packet loss = 0%, RTA = 1.37 ms   |
| Dhanmondi_DIS_B           | UP     | 08-09-2016 15:00:00 | 3d 1h 50m 59s  | PING OK - Packet loss = 0%, RTA = 1.42 ms   |
| Dhanmondi_DO_OLT          | UP     | 08-09-2016 14:58:56 | 2d 14h 43m 35s | PING OK - Packet loss = 0%, RTA = 2.09 ms   |
| Farmgate_ACR              | UP     | 08-09-2016 14:59:03 | 4d 4h 0m 4s    | PING OK - Packet loss = 0%, RTA = 1.44 ms   |
| Farmgate_OLT              | UP     | 08-09-2016 14:58:58 | 4d 8h 3m 21s   | PING OK - Packet loss = 0%, RTA = 1.88 ms   |
| Fokrapool_ACR             | DOWN   | 08-09-2016 15:00:41 | 0d 0h 17m 50s  | (Host check timed out after 30.02 seconds)  |
| Fokrapool_OLT             | DOWN   | 08-09-2016 15:00:04 | 0d 0h 18m 28s  | CRITICAL - Host Unreachable (192.168.124.5) |
| Gopibag_ACR               | UP     | 08-09-2016 15:00:13 | 0d 0h 2m 13s   | PING OK - Packet loss = 28%, RTA = 1.38 ms  |
| Gopibag_OLT               | UP     | 08-09-2016 14:57:40 | 0d 0h 14m 55s  | PING OK - Packet loss = 0%, RTA = 1.58 ms   |
| Gulshan_1_ACR             | UP     | 08-09-2016 15:00:32 | 0d 20h 48m 25s | PING OK - Packet loss = 0%, RTA = 1.04 ms   |
| Gulshan_1_OLT             | UP     | 08-09-2016 14:58:36 | 9d 2h 21m 17s  | PING OK - Packet loss = 0%, RTA = 2.21 ms   |
| Gulshan_2_ACR             | UP     | 08-09-2016 14:57:46 | 0d 18h 24m 16s | PING OK - Packet loss = 0%, RTA = 8.86 ms   |
| Gulshan_2_OLT_Fun_Factory | UP     | 08-09-2016 15:01:42 | 0d 18h 20m 19s | PING OK - Packet loss = 0%, RTA = 1.78 ms   |
| Gulshan_2_OLT_e.co        | UP     | 08-09-2016 14:58:18 | 0d 18h 23m 43s | PING OK - Packet loss = 0%, RTA = 1.92 ms   |
| Jatrabari_ACR             | UP     | 08-09-2016 14:57:51 | 0d 19h 30m 1s  | PING OK - Packet loss = 0%, RTA = 1.35 ms   |
| Jatrabari_OLT             | UP     | 08-09-2016 14:59:01 | 1d 20h 43m 56s | PING OK - Packet loss = 0%, RTA = 4.45 ms   |
| KarwanBazar_ACR           | UP     | 08-09-2016 14:58:09 | 5d 0h 9m 48s   | PING OK - Packet loss = 0%, RTA = 0.94 ms   |
| KarwanBazar_OLT           | UP     | 08-09-2016 14:57:53 | 0d 18h 24m 5s  | PING OK - Packet loss = 0%, RTA = 1.04 ms   |
| Khilgaon_DIS_A            | UP     | 08-09-2016 15:00:20 | 8d 21h 36m 31s | PING OK - Packet loss = 0%, RTA = 1.13 ms   |
| Khilgaon_DIS_B            | UP     | 08-09-2016 15:00:35 | 8d 21h 36m 15s | PING OK - Packet loss = 0%, RTA = 1.13 ms   |
| Khilgaon_DO_OLT           | UP     | 08-09-2016 15:00:39 | 8d 21h 36m 8s  | PING OK - Packet loss = 0%, RTA = 2.18 ms   |
| Lalmata_ACR               | UP     | 08-09-2016 14:57:46 | 0d 18h 24m 14s | PING OK - Packet loss = 0%, RTA = 1.78 ms   |
| Lalmata_OLT               | UP     | 08-09-2016 14:57:50 | 0d 18h 24m 11s | PING OK - Packet loss = 0%, RTA = 2.22 ms   |
| Mirpur_11_OLT             | UP     | 08-09-2016 14:59:37 | 5d 2h 40m 8s   | PING OK - Packet loss = 0%, RTA = 2.04 ms   |
| Mirpur_DIS_A              | UP     | 08-09-2016 14:57:28 | 3d 14h 8m 14s  | PING OK - Packet loss = 0%, RTA = 1.21 ms   |
| Mirpur_DIS_B              | UP     | 08-09-2016 14:57:32 | 3d 14h 8m 17s  | PING OK - Packet loss = 0%, RTA = 1.21 ms   |
| Mirpur_DO_OLT             | UP     | 08-09-2016 14:59:51 | 2d 4h 59m 36s  | PING OK - Packet loss = 0%, RTA = 1.94 ms   |

Figure 4.3 Nagios

## 4.3 Cacti with MRTG

Cacti is an open source network monitoring and graphing tools. Cacti allows a user to provide services at predetermined intervals and graph the resulting data. It is generally used to graph time series data of metrics such as CPU load and network bandwidth utilization. And we used cacti for monitoring our network bandwidth utilization.

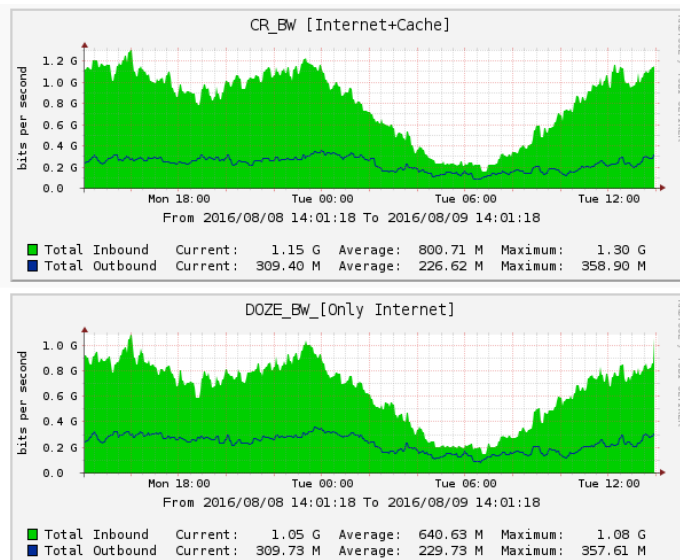

Figure 4.4 Cacti with MRTG

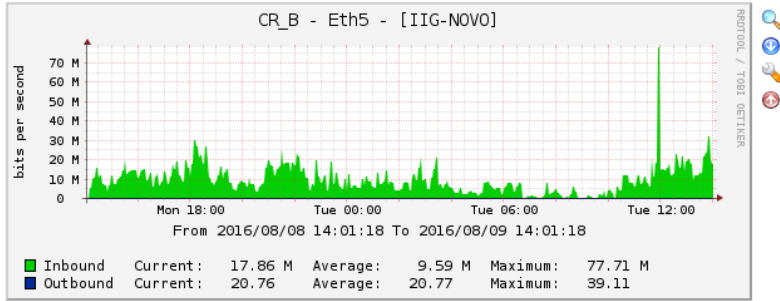
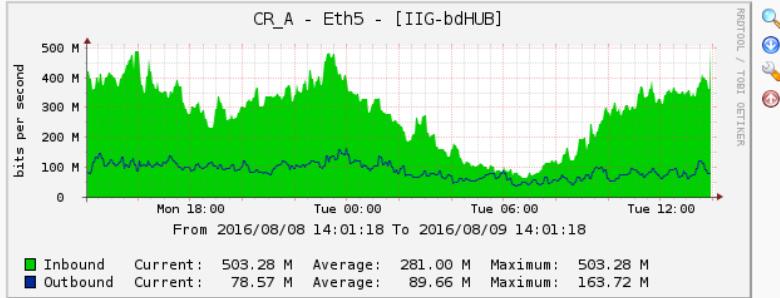

Figure 4.5 Cacti with MRTG

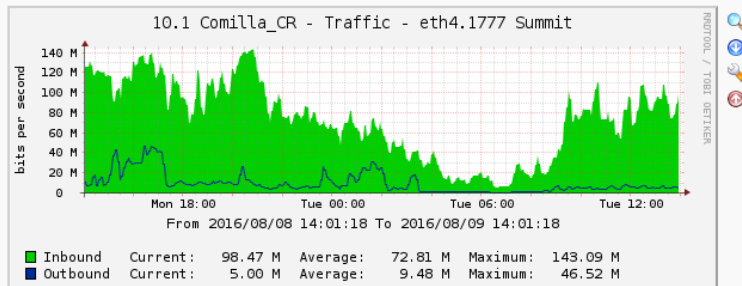
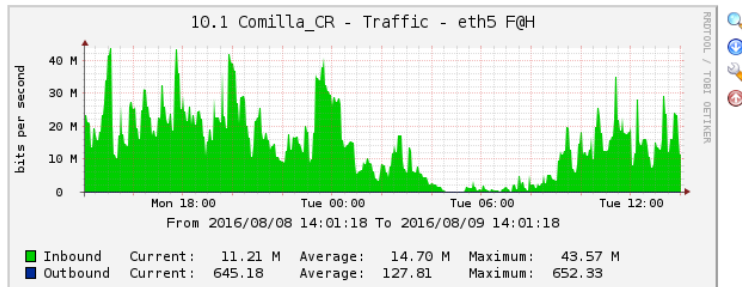

Figure 4.6 Cacti with MRTG

## **Chapter 5**

### **Conclusion**

Internship is an opportunity to acquire a real life experience of what I learned in my academic life. Working as an intern in the Network operations center of DOZE internet. I have learnt to be dedicated to the job. Dedicativemindset is the most important thing to work in such a sophisticated environment. It is beyond more official matter. For most of the engineering or technical company, the engineers have to get attached with the working process. 24x7 service monitoring has taught me how to handle technical staffs in an efficient manner. As there was an opportunity to serve DOZE internet many ways. I have gathered a lot of experience throughout the entire internship period. There was a scope in the field of computer network planning and designing, Data connectivity, ensuring security, different types of application configuration and maintain. In this report I have explained my experiences and about Network Designing and Optimization. I have learned so many significant procedures from my supervisors and colleagues and conducted some tasks on a regular basis throughout my entire Internship period and ultimately earned the confidence to deal with assignment myself. It is a great opportunity to use the knowledge and skills that I had acquired. I also learned how to handle critical faults and got the new ideas. Doing this kind of work is really helpful for my career and I like to do this kind of work ag



## References

- [1] <http://openbookproject.net/courses/intro2ict/networking/intro.html>
- [2] [https://en.wikipedia.org/wiki/Computer\\_network](https://en.wikipedia.org/wiki/Computer_network)
- [3] <http://www.pctechauthority.com/learn-pc-networking/intro-to-network-communications.html>
- [4] <http://www.dozeinternet.com/>
- [5] <http://network-tools.com/>
- [6] <http://cacti.smile.com.bd/>
- [7] [http://upload.ecvv.com/upload/Product/20098/China\\_Fiber\\_Optic\\_Media\\_Converter20098281545522.jpg](http://upload.ecvv.com/upload/Product/20098/China_Fiber_Optic_Media_Converter20098281545522.jpg)
- [8] <http://www.scte.org/documents/pdf/CCNA4%20Sample.pdf>
- [9] <http://www.scte.org/documents/pdf/CCNA4%20Sample.pdf>
- [10] [https://en.wikipedia.org/wiki/Network\\_switch](https://en.wikipedia.org/wiki/Network_switch)
- [11] [https://en.wikipedia.org/wiki/Fiber\\_media\\_converter](https://en.wikipedia.org/wiki/Fiber_media_converter)
- [12] [https://www.google.com.bd/search?q=optical+network+unit&biw=1366&bih=609&source=lnms&sa=X&ved=0ahUKEwiwjuDbobLOAhUQTI8KHaoICZkQ\\_AUIBygA&dpr=1](https://www.google.com.bd/search?q=optical+network+unit&biw=1366&bih=609&source=lnms&sa=X&ved=0ahUKEwiwjuDbobLOAhUQTI8KHaoICZkQ_AUIBygA&dpr=1)
- [13] <http://103.239.252.254/nagios/>
- [14] [http://103.239.252.158/cacti/graph\\_view.php?action=tree&tree\\_id=3&leaf\\_id=115&select\\_filter=true](http://103.239.252.158/cacti/graph_view.php?action=tree&tree_id=3&leaf_id=115&select_filter=true)
- [15] [https://www.google.com.bd/search?q=Hierarchical+Design+of+a+Network.&biw=1366&bih=609&source=lnms&sa=X&ved=0ahUKEwjykuGBqrLOAhXFu48KHVafDvYQ\\_AUIBygA&dpr=1](https://www.google.com.bd/search?q=Hierarchical+Design+of+a+Network.&biw=1366&bih=609&source=lnms&sa=X&ved=0ahUKEwjykuGBqrLOAhXFu48KHVafDvYQ_AUIBygA&dpr=1)
- [16] <http://www.exfiber.com/product/GEAPON/Optical-Network-Unit/Optical-Network-Unit-list1.html>
- [17] <https://en.wikipedia.org/wiki/MikroTik>